



Emulex[®] Drivers for VMware ESXi

User Guide
Release 14.0

Broadcom, the pulse logo, Connecting everything, Avago Technologies, Avago, the A logo, Brocade, Emulex, ExpressLane, LightPulse, LSI, OneCommand, and SLI are among the trademarks of Broadcom and/or its affiliates in the United States, certain other countries, and/or the EU.

Copyright © 2003–2021 Broadcom. All Rights Reserved.

The term “Broadcom” refers to Broadcom Inc. and/or its subsidiaries. For more information, please visit www.broadcom.com.

Broadcom reserves the right to make changes without further notice to any products or data herein to improve reliability, function, or design. Information furnished by Broadcom is believed to be accurate and reliable. However, Broadcom does not assume any liability arising out of the application or use of this information, nor the application or use of any product or circuit described herein, neither does it convey any license under its patent rights nor the rights of others.

Table of Contents

Chapter 1: Introduction	5
1.1 ESXi Compatibility	5
1.2 Supported Guest Operating Systems	6
1.3 Abbreviations	6
Chapter 2: Installation	8
2.1 Installing the FC and NVMe over FC Driver	8
2.1.1 Installing the FC Driver and Management Software	8
2.1.2 Uninstalling the FC Driver	8
2.1.3 Installing the Native Mode FC Driver esxcli Plug-In	8
2.2 Supported Commands	9
2.3 Updating Drivers	10
2.3.1 Updating Drivers Using VMware Offline Bundle Media	10
2.3.2 Updating Drivers with the VMware Component	10
2.4 Installing the esxcli Management Tool	11
Chapter 3: Configuration	12
3.1 ESXi Command Line Tool Transition	12
3.1.1 ESXi CLI Implementation	12
3.2 FC Driver Configuration	12
3.2.1 Configuration Methods for FC Driver Parameters	13
3.2.2 Emulex ExpressLane Support	14
3.2.3 FC-SP-2 Authentication (DH-CHAP) Support	15
3.2.4 Trunking Support	16
3.2.5 Dynamically Adding LUNs	17
3.2.6 Dynamically Adding Targets	17
3.2.7 FC Driver Module Parameters	18
3.2.8 Creating an FC Remote Boot Disk	26
3.2.9 Managing Devices through the CIM Interface	27
3.2.10 Installing the Emulex CIM Provider	28
3.2.11 Creating, Deleting, and Displaying vPorts	28
3.2.12 Configuring VVols	28
3.2.13 Adjusting the LUN Queue Depth	29
3.3 Configuring NVMe over FC on a Target	30
3.4 Configuring NVMe over FC on an Initiator System	30
3.4.1 Creating Datastores Using CLI Commands	32
3.4.2 Creating Datastores Using the vSphere Client GUI	33
3.4.3 Completing the Initiator Configuration	36

Chapter 4: Troubleshooting the FC Driver	40
4.1 FC Driver Log Messages	43
4.2 FC Driver Error Log Messages and Their Descriptions	44
Chapter 5: Troubleshooting the NVMe Driver	90
5.1 Troubleshooting the NVMe Driver	90
5.2 Using VMware Commands	91
5.2.1 Checking the Status of an NVMe Controller	91
5.2.2 Verifying that NVMe Target Ports Are Discovered.....	92
5.2.3 Listing NVMe Adapters on an ESXi Host.....	93
5.2.4 Discovering NVMe Controllers Connected to Target Ports.....	93
5.2.5 Viewing Multipath Information.....	94
5.3 NVMe Driver Error Log Messages and Their Descriptions	94
Appendix A: esxcli Management Tool.....	95
A.1 Usage	95
A.2 esxcli Management Commands	96
Appendix B: lpfc Driver BlockGuard Functionality	104
B.1 Overview	104
B.2 Enabling BlockGuard	105
B.3 SCSI Command Support – SCSI Operation Codes	105
B.4 lpfc Driver Module Parameters	106
B.4.1 lpfc_prot_mask	106
B.4.2 lpfc_prot_guard	107
Appendix C: Using the VMID Feature on a Brocade Switch.....	108
Appendix D: Using the VMID Feature on a Cisco Switch	110
Appendix E: NPIV Configuration.....	112
Appendix F: License Notices.....	116
F.1 OpenSSL Notice	116

Chapter 1: Introduction

This product supports the following Emulex® HBAs:

- LPe31000-series adapters
- LPe32000-series adapters
- LPe35000-series adapters
- LPe36000-series adapters

The VMware ESXi drivers support the FC protocol. In addition, ESXi 7.0 supports NVMe over FC on Emulex LPe31000-series, LPe32000-series, LPe35000-series, and LPe36000-series adapters in initiator systems. This document explains how to install the VMware ESXi drivers on your system and how to configure the drivers' capabilities. The following is a partial list of configurable VMware ESXi features:

- Adding LUNs and targets
- Configuring driver parameters
- Creating an FC remote boot disk
- Managing devices through the CIM interface
- Working with vPorts
- Configuring VVols
- Troubleshooting FC issues

Refer to the *Emulex HBA Manager Application User Guide* and the *Emulex HBA Manager Application for VMware vCenter User Guide* for a complete list of supported technology.

NOTE: The Emulex OneCommand™ Manager application has been renamed as the Emulex HBA Manager application.

NVMe over FC is a relatively new protocol for solid-state storage devices built with nonvolatile memory technologies. NVMe provides substantially lower latency for storage I/O operations and significantly higher IOPs per device. NVMe scales up the number of devices it can address by adopting NVMe over fabric technology. LPe31000-series, LPe32000-series, LPe35000-series, and LPe36000-series HBAs are enabled for NVMe over fabrics. NVMe-enabled HBAs support NVMe over fabrics and SCSI concurrently, allowing data centers to transition to all-flash storage at their own pace.

You will need a basic understanding of NVMe over FC before configuring it. You can use a search engine to find various websites and books that describe NVMe over FC. In particular, you will need to understand the concept of namespaces (the NVMe equivalent of SCSI LUNs) and NVMe subsystems (containers of SCSI LUN equivalents).

Refer to the *Emulex Drivers for VMware ESXi Release Notes* for known issues regarding NVMe over FC support.

1.1 ESXi Compatibility

For information on compatible firmware versions, go to www.broadcom.com.

1.2 Supported Guest Operating Systems

The Emulex drivers support the following guest operating systems:

- CentOS 7.x
- CentOS 8.x
- Oracle Linux 7.x and Oracle Linux 8.x
- Oracle UEKR4 and R5
- OVM 3.3.3
- OVM 3.4.1
- RHEL 7.8 and subsequent releases
- RHEL 8.3 and subsequent releases
- SLES 12 SP4 and subsequent releases
- SLES 15 SP2 and subsequent releases
- Windows Server 2016
- Windows Server 2019
- Windows Server 2022
- XenServer Citrix 7.0

1.3 Abbreviations

The following table lists the acronyms and abbreviations used in this document.

Table 1: Acronyms and Abbreviations

Acronym/Abbreviation	Description
ABTS	abort sequence
BLS	basic link services
CDB	Command Descriptor Block
CS_CTL	Class-Specific Control
CT	common transport
DA_ID	destination address identifier
DH-CHAP	Diffie-Hellman Challenge Handshake Authentication Protocol
DID	device ID
DIF	data integrity field
ELS	Extended Link Service
EQ	event queue
F_Port	fabric port
FA-PWWN	Fabric Assigned Port WWN
FC-GS	Fiber Channel Generic Services
FC-SP	Fibre Channel Security Protocol
FCF	Fibre Channel Forwarder
FCID	Fiber Channel Identifier
FCP	Fibre Channel Protocol
FDISC	F_Port_Discovery
FDMI	Fabric-Device Management Interface
FLOGI	fabric login

Table 1: Acronyms and Abbreviations (Continued)

Acronym/Abbreviation	Description
GA	general availability
GB	gigabyte
Gb/s	gigabits per second
GPT	GUID partition table
GUID	globally unique identifier
I/O	input/output
ID	identifier
IOCB	input/output control block
IOCTL	input/output control
IODM	I/O Device Management
KV	key value
LBA	logical block address
LIF	logical interface
LIP	Loop Initialization Primitive
LPFC	LightPulse [®] Fibre Channel
MB	megabyte
MSI	message signaled interrupt
NFA	Network Flow Analysis
NLP	natural language processing
NPIV	N_Port ID virtualization
NQN	NVMe qualified name
OB	OpenBoot
OXID	Fibre Channel originator exchange
PE	protocol endpoint
PLOGI	port login
RDM	raw device mapping
RSCN	registered state change notification
RSP	route/switch processor
SGE	scatter-gather element
SGL	scatter-gather list
VASA	vSphere APIs for Storage Awareness
VIB	vSphere Installation Bundle
VMFS	virtual machine file system
VMID	Virtual Machine Identifier
VPD	vital product data
vPort	virtual port
VVols	virtual volumes
XRI	Extensible Resource Indicator

Chapter 2: Installation

This section provides information for installing the ESXi driver for the FC protocol.

2.1 Installing the FC and NVMe over FC Driver

This section provides installation information for the driver and the Emulex CIM Provider using the FC interface on ESXi systems. Before using this product, you need a working knowledge of FC storage devices.

2.1.1 Installing the FC Driver and Management Software

The Emulex driver is available through the VMware support website. Go to the VMware support website for further details.

For VMware ESXi 6.7 and subsequent operating systems releases, you can manage adapters using the Emulex HBA Manager application on Windows or the Emulex HBA Manager application for VMware vCenter, but you must install and use the appropriate Emulex CIM Provider. Refer to the *Emulex HBA Manager Application User Guide* and the *Emulex HBA Manager Application for VMware vCenter User Guide* for instructions on installing the respective applications. The installation requires that the CIM Provider be installed. For more information on installing the CIM Provider, refer to the *Emulex CIM Provider Installation Guide*.

NOTE: Before installing the management application, you must install the FC driver from the VMware website and then reboot the server.

Before installing the FC driver and CIM Provider, verify that the firmware version is correct. If it is, proceed with the installation. If it is not, update the firmware using the Emulex HBA Manager application from a Windows server or the Emulex HBA Manager application for VMware vCenter, and reboot the system before proceeding with the installation.

2.1.2 Uninstalling the FC Driver

Go to the VMware patch download page on the VMware website for instructions.

2.1.3 Installing the Native Mode FC Driver esxcli Plug-In

This section describes the installation and usage of the `esxcli` plug-in for the native mode FC (lpfc) driver on ESXi 6.7 systems. This diagnostic tool is for the FC driver module.

NOTE: You can download the `esxcli` plug-in from the Broadcom® website.

To install the `esxcli elxlc` plug-in for ESXi 6.7, perform the following steps:

1. Unzip and copy the following file to `/var/log/vmware/` on the ESXi host:

```
EMU-esx-6.x.x-elxlpfccli-<VIB_version>-offline_bundle-<OS_version>.zip
```

2. On the ESXi host, install the VIB as follows:

```
esxcli software vib install -d /<pathname>/EMU-esx-6.x.x-elxlpfccli-<VIB_version>-  
offline_bundle-<OS_version>.zip
```

- Restart the `hostd` using the following command:

```
/etc/init.d/hostd restart
```

After the `hostd` has restarted, the `elxfc` namespace appears under `esxcli`.

To install the `esxcli elxfc` plug-in for ESXi 7.0 and subsequent operating system releases, perform these steps:

- On the ESXi host, install the component as follows:

```
esxcli software component apply -d /<pathname>/Broadcom-ELX-esxcli-
elxfc_<component_version>-1OEM.700.0.0.<OS_version>-signed_component-
<build_version>.zip
```

where `<component_version>` represents the `elxfc` vib version

- Restart the `hostd` using the following command:

```
/etc/init.d/hostd restart
```

After the driver has restarted, the `elxfc` namespace appears under `esxcli`.

2.2 Supported Commands

The following command is supported on `elxfc`:

```
esxcli elxfc
```

Usage:

```
esxcli elxfc <cmd> <cmd options>
```

Table 2: Available Namespaces

Namespace	Description
<code>adapter</code>	Adapter information of an Emulex FC HBA
<code>bginjerr</code>	BlockGuard error injection page information of an Emulex FC HBA
<code>dhchap</code>	Authentication information of an Emulex FC adapter
<code>event</code>	Events information of an Emulex FC HBA
<code>eventsnap</code>	Events information with snap after display of an Emulex FC HBA
<code>fcf</code>	FCF table information of an Emulex FC HBA
<code>heap</code>	Heap usage statistics and information of an Emulex FC HBA
<code>iostat</code>	I/O statistics information of an Emulex FC HBA
<code>kv</code>	KV page information of an Emulex FC HBA
<code>logmessage</code>	Log message of an Emulex FC HBA in <code>vmkernel.log</code>
<code>lun</code>	SAN LUN information of an Emulex FC HBA
<code>memlog</code>	Memlog information of an Emulex FC HBA
<code>memory</code>	Memory statistics and information of an Emulex FC HBA
<code>mgmt</code>	Management statistics and information of an Emulex FC HBA
<code>modinfo</code>	Module information of an Emulex FC HBA
<code>node</code>	Nodes in SAN information of an Emulex FC HBA
<code>param</code>	Dynamic configuration parameter information of an Emulex FC HBA
<code>port</code>	Port information and statistics of an Emulex FC HBA
<code>rsnn</code>	Symbolic node name information of an Emulex FC HBA
<code>sli4q</code>	sli4q information of an Emulex FC HBA
<code>target</code>	SAN targets information of an Emulex FC HBA

Table 2: Available Namespaces (Continued)

Namespace	Description
vmid	VMID page information of an Emulex FC HBA
xlane	Emulex FC HBA instances ExpressLane™ information

Table 3: Available Commands

Command	Description
list	Lists Emulex FC adapter instance names

2.3 Updating Drivers

2.3.1 Updating Drivers Using VMware Offline Bundle Media

VMware recommends using the offline bundle to update software on VMware ESXi 6.7 platforms.

NOTE: For more information about ESXi patch management activities, go to the VMware website.

To update a driver using the offline bundle media, perform the following steps:

1. Run the following command to update the driver.

```
esxcli software vib install --maintenance-mode -d <pathname>/Broadcom-ELX-
lpfc_<component_version>-1OEM.670.0.0.<OS_version>_<build_version>.zip
where <component_version> represents the FC driver.
```

2. Reboot the VMware ESXi server to activate the drivers.

2.3.2 Updating Drivers with the VMware Component

VMware recommends using the component to update software on VMware ESXi 7.0 and subsequent operating system platforms.

To update a driver using the component, perform the following steps:

1. Run the following command to update the driver:

```
esxcli software component apply -d <pathname>/Broadcom-ELX-lpfc_<component_version>-
1OEM.700.1.1.0.<OS_version>_<build_version>.zip
where <component_version> represents the FC/ NVMe driver.
```

2. Reboot the VMware ESXi server to activate the drivers.

2.4 Installing the esxcli Management Tool

The esxcli management tool is delivered as an offline bundle or as a component for the `esxcli` plug-in.

To install the esxcli management tool in ESXi 6.7, perform the following steps:

1. Copy the offline bundle to the ESXi host.
2. On the ESXi host, install the offline bundle as follows:

```
esxcli software vib install -d /<pathname>/EMU-esx-6.x.x-elxmgmt-<VIB_version>-offline_bundle-<OS_version>.zip
```

3. Restart the `hostd` using the following command:

```
/etc/init.d/hostd restart
```

To install the esxcli management tool in ESXi 7.0 and subsequent operating system releases, perform the following steps:

1. Copy the component to the ESXi host.
2. On the ESXi host, install the component as follows:

```
esxcli software component apply -d /<pathname>/Broadcom-ELX-esxcli-elxmgmt_<component_version>-10EM.700.1.0.<OS_version>_<build_version>.zip
```

where `<component_version>` represents the FC or NVMe driver.

3. Restart the `hostd` using the following command:

```
/etc/init.d/hostd restart
```

Chapter 3: Configuration

This chapter provides configuration information for the ESXi driver.

3.1 ESXi Command Line Tool Transition

Beginning with the ESXi 6.7 release, VMware transitioned from `esxcfg` commands to `esxcli` commands. This section describes the transition to the `esxcli` commands.

NOTE: Both sets of commands are supported in the ESXi 6.7 and later operating system releases.

3.1.1 ESXi CLI Implementation

For ESXi 6.7 and later operating system releases, Broadcom uses the `esxcli` version of the command sequence, which has a different command syntax than the earlier releases. Some examples follow.

Following is the command syntax to list the supported parameters by a driver:

```
~ # esxcli system module parameters list -m <driver binary name>
```

Following is the command syntax for setting a parameter to a driver module:

```
~ # esxcli system module parameters set -p <parameter_string> -m <driver binary name>
```

3.1.1.1 FC Driver Example

To set extended logging for the Emulex FC driver:

```
~ # esxcli system module parameters set -p lpfc_log_verbose=0x10c3 -m lpfc
```

To list the parameter values assigned to a driver module:

```
~ # esxcli system module parameters list -m lpfc
```

This command is the same as listing parameters. The parameter set has the *value* column completed if applicable. This command lists all instance and global parameters, which makes it necessary to watch for any altered driver parameters.

3.2 FC Driver Configuration

You can configure driver parameters using native ESXi tools, the Emulex HBA Manager application (for use in non-lockdown mode only), or the Emulex HBA Manager application for VMware vCenter (for use in both lockdown and non-lockdown modes).

This section describes how to configure parameters using native ESXi tools. For a more comprehensive description of ESXi tools, go to the VMware public website. If you have further questions, contact a VMware technical support representative.

Refer to the *Emulex HBA Manager Application User Guide* and the *Emulex HBA Manager Application Command Line Interface User Guide* for information about the Emulex HBA Manager application.

Refer to the *Emulex HBA Manager Application for VMware vCenter User Guide* for information about the Emulex HBA Manager application for VMware vCenter.

3.2.1 Configuration Methods for FC Driver Parameters

Configure the driver parameters using any of the following methods:

- Permanent (global)
- Permanent (per adapter)
- Temporary (global)
- Temporary (per adapter)

The Emulex HBA Manager application supports all four configuration methods for driver parameters. Refer to the *Emulex HBA Manager Application User Guide* or the *Emulex HBA Manager Application for VMware vCenter User Guide* for more information.

The native ESXi tools support only permanent configuration methods for the driver parameters. The following section provides further information on permanent configuration methods.

3.2.1.1 Permanent FC Configuration Methods Using Native ESXi Tools

Permanent configuration requires that the new values be saved in the ESXi environment. These changes are considered permanent because they persist across system reboots.

See [Section 3.2.7, FC Driver Module Parameters](#), for parameter names and values. Parameter values are in both hexadecimal and decimal.

NOTE: For ESXi systems, the following steps must be executed from the Troubleshooting Administrative Shell environment. If your configuration does not provide access to this shell, refer to VMware vSphere or VMware vCenter server manual for enabling driver logging. Alternatively, refer to the *Emulex CIM Provider Installation Guide* for driver logging.

To make changes that impact all adapters in the system (global changes), perform the following steps:

1. From the Troubleshooting Administrative Shell environment's terminal window, type the following command:

```
esxcli system module parameters set -p "param1=value param2=value ..." -m lpfc
```

NOTE: Use quotation marks around the parameter values only when listing two or more values.

2. Reboot the server by typing the following command:

```
reboot
```

NOTE: VMware does not officially support unloading the driver using `vmkload_mod -u`. If you must unload the driver, contact a VMware technical support representative.

NOTE: The VMware vCenter Server is used to create and delete NPIV ports. For more information, see [Appendix E, NPIV Configuration](#).

3.2.1.1.1 Example of Permanent Global Configuration

The following example sets `lun_queue_depth` (the maximum number of commands that can be sent to a single LUN) to 20 (the default is 64) for all adapters in your system.

1. Locate the parameter `lpfc_lun_queue_depth` in [Table 4](#).
2. Set the permanent value by typing the following command:

```
esxcli system module parameters set -p lpfc_lun_queue_depth=20 -m lpfc
```

3. To reboot the server, type the following command:

```
reboot
```

The new setting is used when the driver reloads.

To verify the setting, type the following command:

```
esxcli system module parameters list -m lpfc
```

3.2.1.1.2 Examples of Permanent Per-Adapter Configuration

The following example sets `lun_queue_depth` to 20 (the default is 64) for adapter 1.

1. Set the adapter-specific value by typing the following command:

```
esxcli system module parameters set -p lpfc1_lun_queue_depth=20 -m lpfc
```

2. To reboot the server, type the following command:

```
reboot
```

The new setting is used when the driver is reloaded.

To verify the setting, type the following command:

```
esxcli system module parameters list -m lpfc
```

The following example sets `lun_queue_depth` to 20 (the default is 64) for adapter 1 and `lun_queue_depth` to 10 (the default is 30) for adapter 2.

1. Set the adapter-specific value by typing:

```
esxcli system module parameters set -p "lpfc1_lun_queue_depth=20, lpfc2_lun_queue_depth=10" -m lpfc
```

NOTE: Type the command all on one line without pressing **Enter**.

2. To reboot the server, type the following command:

```
reboot
```

The new settings are used when the driver is reloaded.

To verify the settings, type the following command:

```
esxcli system module parameters list -m lpfc
```

3.2.2 Emulex ExpressLane Support

The host servers do not distinguish between lower and higher priority workloads being sent to LUNs. For flash storage deployed in mixed storage environments, the combination of data from rotating media and flash devices can cause congestion on the network and reduced performance for the flash storage devices.

The ExpressLane feature enables special priority queuing for selected LUNs (ExpressLane LUNs). ExpressLane LUN performance is superior to that of regular LUNs. Mixed storage environments can use the ExpressLane feature to alleviate congestion, reduce latency, and improve throughput, ensuring that key applications receive highest priority. Switches can provide up to three priority levels: Low, Medium, and High.

The following information applies to the ExpressLane feature:

- An ExpressLane LUN must be enabled in the driver before it can be used by the Emulex HBA Manager application for VMware vCenter. Additionally, the priority value to mark each of the ExpressLane frames must be specified to the FC driver through the appropriate driver parameters.
- The ExpressLane feature is not supported for LUNs attached to virtual ports.

For additional information, refer to the *Emulex HBA Manager for VMware vCenter User Guide*.

3.2.3 FC-SP-2 Authentication (DH-CHAP) Support

Fibre Channel Security Protocol (FC-SP-2) DH-CHAP is a secret-based authentication and key management protocol that uses the CHAP algorithm augmented with an optional Diffie-Hellmann algorithm with hash priority (MD5 and SHA1).

NOTE: The following information applies to DH-CHAP support:

- DH-CHAP is available only for physical ports, not for virtual ports.
- The authentication driver parameters are only available on local hosts and not for any remote hosts.
- Boot from SAN is not supported when DH-CHAP authentication is enabled.
- DH-CHAP is not supported on FA-PWWN ports.
- DH-CHAP is not supported if Dynamic D_Port is enabled.

You can configure FC-SP-2 DH-CHAP authentication between an adapter and a switch.

FC-SP-2 DH-CHAP authentication is disabled by default. To enable FC-SP-2 DH-CHAP authentication, you must pass the `lpfc_enable_auth` parameter to the driver by typing the following command:

```
# esxcli system module parameters set -p lpfc_enable_auth=1 -m lpfc
```

You must reboot the system to activate the parameter.

After DH-CHAP has been activated and configured, you can manually initiate authentication per adapter. For more information on manually initiating authentication, refer to the *Emulex HBA Manager Application User Guide*.

You can get, set, update, or delete a password using the Emulex HBA Manager application. For details on how to perform these operations, refer to the *Emulex HBA Manager Application User Guide*.

You can also display authentication configuration using the `keyval` page and `esxcli`.

For example, in the `keyval` page, type the following command:

```
/usr/lib/vmware/vmkmgmt_keyval/vmkmgmt_keyval -i vmhba4/Emulex -g -k auth
```

Output similar to the following is shown:

```
Key 'auth':      Authentication info: Authentication enabled
local WWPN 10:00:00:90:fa:c7:c2:a8      remote WWPN ff:ff:ff:ff:ff:ff:ff:ff
```

`ff:ff:ff:ff:ff:ff:ff:ff` is the switch port name.

3.2.4 Trunking Support

Trunking enables you to combine multiple physical FC links to form a single logical link (aggregated port). The aggregated port's maximum link speed is the sum of the maximum link speeds of the individual physical links comprising the aggregated port. The actual link speed of the aggregated port depends on the states (active or non-active) of the individual physical links comprising the aggregated port.

The physical links comprising an aggregated port are referred to as lanes. Both 2-lane and 4-lane aggregated ports are supported.

The LPe35002 and LPe36002 adapters support 2-lane port aggregation. If 2-lane port aggregation is configured on a dual-port adapter, the two physical links are combined to form a single 2-lane aggregated port whose aggregate speed is two times the maximum speed supported, assuming both physical links are active.

For example:

- On an LPe35002-series adapter, an aggregated port comprised of two physical links running at 32Gb/s each has a potential logical (aggregate) link speed of 64Gb/s.
- On an LPe36002-series adapter, an aggregated port comprised of two physical links running at 64Gb/s each has a potential logical (aggregate) link speed of 128Gb/s.

An LPe35004 adapter supports both 2-lane port aggregation and 4-lane port aggregation as follows:

- If 2-lane port aggregation is configured on an LPe35004 adapter, the four physical links on the adapter are divided among two separate aggregated ports. The two lowest-numbered physical links form the first aggregated port, and the two highest-numbered physical links form the second aggregated port.
- If 4-lane port aggregation is configured on an LPe35004 adapter, all four physical links are combined to form a single 4-lane trunk whose aggregate speed is potentially 128Gb/s, assuming all four links are active, each at 32Gb/s link speed.

NOTE: The following information applies to trunking support:

- Trunking is supported only on LPe35000-series and LPe36000-series adapters.
- Before you enable or disable trunking on the Emulex adapter, follow the instructions from Brocade® to enable or disable trunking on the switch.
- Dynamic D_Port cannot co-exist with the trunking feature. If trunking is enabled, the firmware automatically disables Dynamic D_Port.
- FA-PWWN cannot co-exist with the trunking feature. If trunking is enabled, the firmware automatically disables FA-PWWN and Dynamic D_Port.
- Trunking is not supported at 8Gb/s speeds, and the link will not come up at this speed.

There are no driver parameters to enable trunking. Trunking is a one-time configuration, and the configuration is performed through the Emulex HBA Manager application. For more information on configuring trunking, refer to the *Emulex HBA Manager Application User Guide*.

When trunking is configured for an adapter, internal loopback and external loopback tests are supported. For more information on running loopback tests, refer to the *Emulex HBA Manager Application User Guide*.

You can view the existing trunk links using `esxcli elxmgmt`.

Following is an example of an LPe35002 adapter, showing 2-lane port aggregation with a single SCSI host.

```
# esxcli elxmgmt trunkinfo get -w 10:00:00:10:9b:41:73:8c

Trunking Mode: 2-lane trunking
Trunk Port 0: Logical Link Speed: 64 Gbs
  Physical Link 0: Active
  Physical Link 1: Active
```

Following is an example of an LPe35004 adapter, showing 2-lane port aggregation with a single SCSI host.

```
# esxcli elxmgmt trunkinfo get -w 10:00:00:10:9b:65:dd:24

Trunking Mode: 2-lane trunking

Trunk Port 0: Logical Link Speed: 64 Gbs
  Physical Link 0: Active
  Physical Link 1: Active

Trunk Port 2: Logical Link Speed: 64 Gbs
  Physical Link 2: Active
  Physical Link 3: Active
```

Following is an example of an LPe35004 adapter, showing 4-lane port aggregation with a single SCSI host.

```
# esxcli elxmgmt trunkinfo get -w 10:00:00:10:9b:65:dd:24

Trunking Mode: 4-lane trunking

Trunk Port 0: Logical Link Speed: 128 Gbs
  Physical Link 0: Active
  Physical Link 1: Active
  Physical Link 2: Active
  Physical Link 3: Active
```

3.2.5 Dynamically Adding LUNs

For instructions on dynamically adding LUNs, refer to the section on using rescan in the VMware SAN configuration documentation.

3.2.6 Dynamically Adding Targets

VMware does not provide a native mechanism for dynamically adding targets. After all target and LUN configuration steps have been successfully completed, add the target to the intended fabric zone.

To get the driver to log into the target, either the target or initiator link must be bounced. If the target is configured with security ACLs, the same link bounce requirement applies after the security ACLs are corrected.

To force the ESXi server to rescan all devices, perform one of these actions:

- Run the following command:
`esxcli storage core adapter rescan -A vmhbaX`
- From the vSphere Client, select **Configuration Tab > Storage Adapters**, and then click **Rescan All**.

3.2.7 FC Driver Module Parameters

Table 4 lists the FC driver module parameters, their descriptions, and their corresponding values in ESXi native mode.

Dynamic parameters do not require a system reboot for changes to take effect.

NOTE: Refer to the VMware documentation for quick boot instructions.

Table 4: FC Driver Parameters

Module Parameter	Description	Values	Comments
lpfc_compression_log	Defines how often the compression logs are written (in seconds). This parameter is dynamically updated.	Default = 300 Min. = 5 Max. = 86,400	The driver uses this parameter to periodically write status messages to the <code>vmkernel</code> log. The messages provide state analysis on the paths, targets, and adapter. It differs from <code>throttle</code> in that the <code>throttle</code> stops the driver from spamming the logs on a very high frequency failure.
lpfc_delay_discovery	Delays N_Port discovery when the Clean Address bit is cleared. This parameter requires a system reboot or quick boot.	Default = 0 Min. = 0 Max. = 1	When the parameter is set to 0, no delay is added to the initial discovery. When this parameter is set to 1, initial N_Port discovery is delayed by <code>RA_TOV</code> seconds when the Clean Address bit is cleared in FLOGI/FDISC accept and the FCID/Fabric name/Fabric port name is changed.
lpfc_devloss_tmo	The number of seconds the driver holds I/O waiting for a lost device to return. This parameter is dynamically updated.	Default = 10 Min. = 1 Max. = 255	—
lpfc_discovery_threads	The maximum number of Extended Link Service commands that can be outstanding during discovery. This parameter requires a system reboot or quick boot.	Default = 32 Min. = 1 Max. = 64	—
lpfc_enable_auth	Enables or disables DH-CHAP authentication. This parameter is dynamically updated.	0 = Disable (default) 1 = Enable	NOTE: DH-CHAP and Dynamic D_Port are mutually exclusive. If both features are enabled simultaneously, warning messages will result. You must either disable DH-CHAP using the <code>lpfc_enable_auth</code> parameter, or disable Dynamic D_Port using the Emulex HBA Manager application.
lpfc_enable_bb_credit_recovery	Toggles the Buffer-to-Buffer Credit Recovery feature. This parameter requires a system reboot or quick boot.	0 = Disable 1 = Enable (default)	—
lpfc_enable_da_id	Controls the DA_ID common transport command. Unregisters objects with the fabric NameServer.	0 = Disable 1 = Enable (default)	—

Table 4: FC Driver Parameters (Continued)

Module Parameter	Description	Values	Comments
lpfc_enable_fc4_type	Enables the FC4 type supported. Valid values are: <ul style="list-style-type: none"> 1 = Register FCP only 3 = Register both FCP and NVMe This parameter requires a system reboot or quick boot.	Default = 3 Min. = 1 Max. = 3	
lpfc_enable_fcp_priority	Enables or disables FCP priority. This parameter requires a system reboot or quick boot.	0 = Disable (default) 1 = Enable	<ul style="list-style-type: none"> 0 = Do not use the nodelist priority table (default). 1 = Use the nodelist priority table.
lpfc_enable_mds_diags	Enables MDS diagnostics. This parameter requires a reset of the FC port.	0 = Disable (default) 1 = Enable	Enables or disables the Cisco Fibre Channel Link Diagnostics feature. The parameter should be disabled (set to 0) after diagnostics are complete.
lpfc_enable_qfull	Enable the driver's lun_queue_depth ramp down and ramp up functionality when the SCSI device status is Task Set Full (x28). <ul style="list-style-type: none"> When enabled (value = 1), the Emulex driver gradually reduces the LUN queue depth with each Task Set Full status completion, and then ramps back up as the I/O successfully completes. When disabled (value = 0), the driver takes no action when an I/O completes with a Task Set Full status. This parameter is dynamically updated.	0 = Disable 1 = Enable (default)	Disabling this parameter has a potential impact on the overall VM performance. Consult your target vendor for guidance.
lpfc_enable_rrq	Enables Reinststate Recovery Qualifier functionality. <ul style="list-style-type: none"> 0x0 = Disabled, XRI/OXID use not tracked. 0x1 = XRI/OXID reuse is timed with the resource allocation timeout (R_A_TOV), Reinststate Recovery Qualifier sent. 0x2 = XRI/OXID reuse is timed with R_A_TOV; no reinststate recovery qualifier is sent. This parameter requires a system reboot or quick boot.	Default = 2 Min. = 0 Max. = 2	—

Table 4: FC Driver Parameters (Continued)

Module Parameter	Description	Values	Comments
lpfc_enable_SmartSAN	Enables HPE Smart SAN functionality. The function works with FDMI-2 to provide enhanced fabric diagnostics. This parameter requires a system reboot or quick boot.	0 = Disable (default) 1 = Enable	If lpfc_enable_SmartSAN is set to 1, the driver automatically supports FDMI-2. If lpfc_enable_SmartSAN is set to 0, the driver uses the current value of lpfc_fdmi_on to provide FDMI support – 0 meaning no support or 1 meaning FDMI-1 support. If FDMI-2 fails, the driver falls back to FDMI-1. If lpfc_enable_SmartSAN is set to 1, the driver ignores the lpfc_fdmi_on value and goes directly to FDMI-2 support. Traditional FDMI support means the driver will assume FDMI-2 support; however, if that fails, it falls back to FDMI-1.
lpfc_EnableXLane	Enable ExpressLane. This parameter requires a system reboot or quick boot.	0 = Disable (default) 1 = Enable	NOTE: If the lpfc_vmid_priority_tagging parameter is enabled, EnableXLane is disabled because both features conflict in using the CS_CTL field in FC header.
lpfc_external_dif	Enables external DIF support on select devices. This parameter requires a system reboot or quick boot.	0 = Disabled 1 = Enabled (default)	—
lpfc_fcp_class	Selects the FC class of service for FCP sequences. This parameter requires a system reboot or quick boot.	Default = 3 Min. = 2 Max. = 3	—
lpfc_fcp_wait_abts_rsp	Modifies criteria for reporting completion of aborted I/O. Valid values are: <ul style="list-style-type: none"> ■ 1 = I/O completes after ABTS is issued (default). ■ 3 = I/O completes after receipt of ABTS response or timeout. This parameter requires a system reboot or quick boot.	Default = 1 Min. = 1 Max. = 3	—
lpfc_fdmi_on	Controls FDMI support. This parameter requires a system reboot or quick boot.	0 = Disable 1 = Enable (default)	The values in Table 5 and Table 6 are passed to the switch when lpfc_fdmi_on is set to 1.
lpfc_first_burst_enable	Enables first burst support. This parameter is dynamically updated.	0 = Disable (default) 1 = Enable	—

Table 4: FC Driver Parameters (Continued)

Module Parameter	Description	Values	Comments
lpfc_hba_queue_depth	The maximum number of FCP commands queued to an FC adapter. The driver automatically adjusts the lpfc_hba_queue_depth to match the adapter capabilities. This setting can be overridden. This parameter requires a system reboot or quick boot.	Default = 65536 Min. = 32 Max. = 65536	Changing the lpfc_hba_queue_depth value might lower the IO performance. NOTE: If lpfc_hba_queue_depth is set to a small value and the driver does not have sufficient resources, then the driver might disable NVMe support.
lpfc_iocb_cnt	IOCBs allocated for Extended Link Service, common transport, and abort sequences in increments of 1024. This parameter requires a system reboot or quick boot.	Default = 1 Min. = 1 Max. = 5	—
lpfc_link_speed	Selects link speed. Valid values are: <ul style="list-style-type: none"> ■ 0 = Auto select (default) ■ 16 = 16 Gigabaud ■ 32 = 32 Gigabaud ■ 64 = 64 Gigabaud This parameter is dynamically updated.	Default = 0 Min. = 0 Max. = 32	Setting this option incorrectly can cause the adapter to fail to initialize.
lpfc_log_verbose	Verbose logging bit-mask. This parameter is dynamically updated.	Default = 0 Min. = 0 Max. = 0x7ffffff	—
lpfc_lun_queue_depth	The maximum number of FCP commands that can queue to a specific LUN. NOTE: The driver dynamically limits the runtime lun_queue_depth setting to 1/8 of the hba_queue_depth to prevent I/O starvation. An attempt to set the lun_queue_depth higher than the 1/8 setting results in a failure. The console logs and the adapter KeyVal page reflect the failure. This parameter is dynamically updated.	Default = 64 Min. = 1 Max. = 254	—
lpfc_max_heap_size	Maximum allowable memory consumption per server for the LPFC module. This parameter requires a system reboot or quick boot.	Default = 128 MB Min. = 64 MB Max. = 512 MB	—

Table 4: FC Driver Parameters (Continued)

Module Parameter	Description	Values	Comments
lpfc_max_luns	The maximum number of LUNs allowed. This parameter requires a system reboot or quick boot.	Default = 65,535 Min. = 1 Max. = 65,535	Allows for sparse LUN IDs above 256.
lpfc_max_multiq	Sets how many completion queues the driver is requesting from ESXi for each HBA instance. Each completion queue uses an MSI-X vector. 0 indicates that multiqueue is disabled. This parameter requires a system reboot or quick boot.	Default = 4 Min. = 0 Max. = 8	Sets the number of multiqueue FCP I/O channels. The driver sets this parameter to determine how many completion queues to use per HBA port. Each completion queue consumes an MSI-X vector and defaults to a low number to ensure systems with a large number of HBAs do not run out of vectors.
lpfc_max_scsicmpl_time	Uses the SCSI command completion time to control queue depth to the device. <ul style="list-style-type: none"> ■ 0 = SCSI command completion time is not used for controlling I/O queue depth. ■ N = I/O queue depth is controlled to limit the I/O completion time to N ms. This parameter is dynamically updated.	Default = 0 Min. = 0 Max. = 60,000	—
lpfc_max_targets	The maximum number of discovered targets allowed. This parameter requires a system reboot or quick boot.	Default = 256 Min. = 0 Max. = 4096	A driver parameter to adjust the supported target count.
lpfc_max_vmid	Maximum number of VMs to be tagged. The range is 4 to 255. This parameter requires a system reboot or quick boot.	Default = 8 Min. = 4 Max. = 255	This value indicates the number of VMIDs supported.
lpfc_mem_tracker	Turns memory tracking on or off. This parameter requires a system reboot or quick boot.	0 = Disabled (default) 1 = Enabled	Keeps track of driver heap and slab allocation/free. It is used only when debugging driver memory issues.
lpfc_nlp_slab_cnt	NLP slab entries. This parameter requires a system reboot or quick boot.	Default = 128 Min. = 32 Max. = 256	Controls the size of the driver's node table. This table in turn limits the driver's ability to discover remote ports, fabrics, initiators, and targets in a zone.

Table 4: FC Driver Parameters (Continued)

Module Parameter	Description	Values	Comments
lpfc_ras_fwlog_buffsize	Buffer size to be allocated in host memory for firmware logging. This parameter requires a system reboot or quick boot.	Default = 0 Min. = 0 Max. = 4 The possible values are: <ul style="list-style-type: none"> ■ 0 = Disable firmware log written to the host memory (default) ■ 1 = ¼ MB (256K) host memory to be allocated for the firmware log ■ 2 = ½ MB (512K) host memory to be allocated for the firmware log ■ 3 = ¾ MB (768K) host memory to be allocated for the firmware log ■ 4 = 1 MB host memory to be allocated for the firmware log 	This parameter is supported only on LPe31000-series, LPe32000-series, LPe35000-series, and LPe36000-series adapters.
lpfc_ras_fwlog_level	Firmware logging level. Valid only if firmware logging is enabled. This parameter requires a system reboot or quick boot.	Default = 0 Min. = 0 Max. = 4	This parameter is supported only on LPe31000-series, LPe32000-series, LPe35000-series, and LPe36000-series adapters.
lpfc_rb_slab_cnt	Receive buffer slab entries. This parameter requires a system reboot or quick boot.	Default = 256 Min. = 32 Max. = 256	Controls the maximum number of receive buffers that will be posted to the adapter.
lpfc_scan_down	Start scanning for devices from the highest AL_PA to the lowest. This parameter requires a system reboot or quick boot.	0 = Disable 1 = Enable (default)	—
lpfc_sg_seg_cnt	The maximum scatter/gather segment count for DMA. The maximum data allowed in one scatter/gather element is 0x80000000. This parameter requires a system reboot or quick boot.	Default = 64 Min. = 64 Max. = 4096	—

Table 4: FC Driver Parameters (Continued)

Module Parameter	Description	Values	Comments
lpfc_suppress_link_up	Suppresses link up at initialization: <ul style="list-style-type: none"> ■ 0x0 = Bring up link ■ 0x1 = Do not bring up link ■ 0x2 = Never bring up link This parameter requires a system reboot or quick boot.	Default = 0 Min. = 0 Max. = 2	Change this parameter to assist with SAN issues during ESXi boot.
lpfc_suppress_rsp	Negotiates whether to suppress the RSP from a target during a PLOGI. This parameter is dynamically updated.	Default = 1 Min. = 0 Max. = 1	—
lpfc_task_mgmt_tmo	The maximum time to wait for task management commands to complete. This parameter is dynamically updated.	Default = 60 Min. = 5 Max. = 180	—
lpfc_tgt_queue_depth	The maximum number of FCP commands queued to a specific target port. This parameter is dynamically updated.	Default = 65,535 Min. = 10 Max. = 65,535	The upper threshold is determined by the adapter's capability.
lpfc_throttle_log_cnt	Do not exceed this number of messages logged within lpfc_throttle_log_time. This parameter is dynamically updated.	Default = 10 Minimum = 1 Maximum = 1000	Logging mechanism intended to speed up issue diagnosis by reducing the need to enable driver logging.
lpfc_throttle_log_time	Do not exceed lpfc_throttle_log_cnt number of logs within this time limit (seconds). This parameter is dynamically updated.	Default = 1 Min. = 1 Max. = 60	—
lpfc_topology	Selects FC topology. Valid values are: <ul style="list-style-type: none"> ■ 0x0 = Attempt loop mode then point-to-point ■ 0x01 = Internal loopback mode ■ 0x02 = Attempt point-to-point mode only ■ 0x04 = Attempt loop mode only ■ 0x06 = Attempt point-to-point mode then loop This parameter is dynamically updated.	Default = 0 Min. = 0 Max. = 6	—

Table 4: FC Driver Parameters (Continued)

Module Parameter	Description	Values	Comments
lpfc_use_adisc	Uses address discovery on rediscovery, initiated by RSCN, to authenticate FCP devices instead of port login. This parameter is dynamically updated.	0 = Disable (default) 1 = Enable	—
lpfc_use_msi	Uses preferred MSI-X interrupt mode, if possible. <ul style="list-style-type: none"> ■ 0 = MSI disabled (INTx mode) ■ 1 = MSI enabled ■ 2 = MSI-X enabled This parameter requires a system reboot or quick boot.	Default = 2 Min. = 0 Max. = 2	—
lpfc_vmid_app_header	VMID application ID tagging. This parameter requires a system reboot or quick boot.	0 = Disabled (default) 1 = Enabled	Brocade VMID uses the application service header field to communicate the capability.
lpfc_vmid_inactivity_timeout	Inactivity timeout duration in hours. The range is 0 to 24. This parameter is dynamically updated.	Default = 4 Min. = 0 Max. = 24	VMID is an ID assigned per VM. The VMID is removed when a VM is inactive for <code>lpfc_vmid_inactivity_timeout</code> duration. The <code>lpfc_vmid_inactivity_timeout</code> value is in hexadecimal.
lpfc_vmid_priority_tagging	VMID CS_CTL tagging. Valid values are: <ul style="list-style-type: none"> ■ 0 = Disables priority tagging. Priority tagging is also disabled when the parameter is set to anything other than 1 or 2. ■ 1 = Enables priority tagging only for targets that support it in their PLOGI LS_ACC response. ■ 2 = Enables priority tagging for all targets, whether they support it in their PLOGI LS_ACC response. This parameter requires a system reboot or quick boot.	Default = 0 Min. = 0 Max. = 2	Cisco VMID uses the priority tagging field to communicate the capability.
lpfc_XLanePriority	ExpressLane CS_CTL Priority. Sets the CS_CTL field in the FC header. Refer to the switch vendor administration guide for additional information. This parameter requires a system reboot or quick boot.	Default = 0x0 Min. = 0x0 Max. = 0x7F	—

NOTE: The values in [Table 5](#) and [Table 6](#) are taken from the FC-GS FC Standard documents and are passed to the switch through FC-CT commands. Adapter port attributes are provided for each adapter port. Adapter attributes are provided once for each adapter, no matter the number of ports.

Table 5: Adapter Port Attributes for the `lpfc_fdm_i_on` Parameter

Hexadecimal Value	Information Type
0x001	Supported FC-4 Types
0x002	Supported Speed
0x003	Current Port Speed
0x004	Maximum Frame Size
0x005	Operating System Device Name
0x006	Host Name
0x007	Node Name
0x008	Port Name
0x009	Port Symbolic Name
0x00A	Port Type
0x00B	Supported Classes of Service
0x00C	Port Fabric Name
0x00D	Port Active FC-4 Types
0x101	Port State
0x102	Number of Discovered Ports
0x103	Port Identifier

Table 6: Adapter Attributes for the `lpfc_fdm_i_on` Parameter

Hexadecimal Value	Information Type
0x001	Node Name
0x002	Manufacturer
0x003	Serial Number
0x004	Model
0x005	Model Description
0x006	Hardware Version
0x007	Driver Version
0x008	Option ROM Version (boot code)
0x009	Firmware Version
0x00A	Operating System Name and Version
0x00B	Maximum Common Transport Payload Length
0x00C	Node Symbolic Name

3.2.8 Creating an FC Remote Boot Disk

For instructions on creating an FC remote boot disk, refer to the VMware SAN configuration documentation.

3.2.9 Managing Devices through the CIM Interface

VMware on the visor-based ESXi platforms uses the CIM interface as the only standard management mechanism for device management.

3.2.9.1 Using the Emulex HBA Manager GUI

For VMware ESXi hosts, you can manage adapters using the Emulex HBA Manager application on Windows, but you must install and use the appropriate Emulex CIM Provider.

NOTE: If advanced adapter management capabilities are required (for example, disabling a port), use the Emulex HBA Manager application for VMware vCenter.

When Windows Emulex HBA Manager is used to manage HBAs installed on ESXi 6.7 Update 1, most of the features are unavailable. This is due to recent changes made by VMware to its SFCB daemon.

The following table lists the features that are functional and nonfunctional when Windows Emulex HBA Manager is used to manage HBAs discovered on ESXi 6.7 Update 1.

Functional	Nonfunctional
Discovery	SetPortSpeed
Port Attributes	SetPortEnabled
Hba Attributes	EnableBootCode
Port Statistics	Diagnostics
Server Attributes	WWN Management
DriverParams	Dump
GetXCVRdata	Get IPL File Name
Pcidata	Firmware Download
VPD	Firmware Parameters
	Trunking

Instead of Emulex HBA Manager for Windows, use the Emulex HBA Manager for VMware CLI (`elxvcpcmd`) or the `esxcli elxmgmt` utilities to manage HBAs installed on ESXi 6.7 Update 1.

3.2.9.2 Using the Emulex HBA Manager for VMware vCenter

The Emulex HBA Manager application for VMware vCenter uses the standard CIM interface to manage the adapters and supports CIM-based device and adapter management. The Emulex HBA Manager application for VMware vCenter also supports existing adapter management functionality based on its proprietary management stack and the standard HBA API interface. To manage adapters (including updating the firmware) on an ESXi host using the Emulex HBA Manager application for VMware vCenter, you must install the out-of-box Emulex CIM Provider on the host.

For more information on installing the Emulex HBA Manager application for VMware vCenter and enabling the CIM Provider, refer to the *Emulex HBA Manager Application for VMware vCenter User Guide*.

NOTE: For the ESXi 6.7 and ESXi7.0 vSphere Web client, flex is not supported, so you must use the vSphere client, HTML.

NOTE: For LPe35000-series and LPe36000-series adapters only:

In some cases, a firmware update requires either a firmware reset or a basic PCIe reset, depending on the features available in the new firmware. A firmware reset is performed automatically if it is needed, regardless of the operating system. In some cases, a full reboot is required to activate new firmware or to enable a new feature. In that case, a message similar to one of the following messages appears after the firmware download is complete:

```
Download successfully completed. Please reboot the system to activate new firmware.
```

```
Download completed. Some features require an optional reboot. Refer to the Adapter's  
Firmware and Boot Code Release Notes for details.
```

For a list of features that require a reboot to be enabled, refer to the adapter's firmware and boot code release notes.

3.2.10 Installing the Emulex CIM Provider

Refer to the *Emulex CIM Provider Installation Guide* for instructions on installing the Emulex CIM Provider.

3.2.11 Creating, Deleting, and Displaying vPorts

The Emulex driver for VMware supports NPIV by default. ESXi provides the VMware vCenter Server for creating and deleting a vPort and creating an NPIV-enabled VM, see [Appendix E, NPIV Configuration](#), for more information. vPorts in the driver discover the fabric just like physical ports do, and they are subject to the same SAN delays. As the number of vPorts increases, the amount of time it takes to complete remote port discovery increases because the vPorts are created sequentially and each vPort executes discovery synchronously. If your NPIV-enabled virtual machines power-on automatically, powering on could take longer than usual. This behavior is normal for NPIV virtual machines.

NOTE: The following information applies to vPorts:

- Ensure you are using the latest recommended firmware for vPort functionality. Check the Broadcom website for the latest firmware.
- Loop devices and NPIV are not supported on the same port at the same time. If you are running a loop topology and you create a vPort, the vPorts link state is offline. VMware ESXi supports fabric mode only.
- You can create vPorts only on 16, 32, and 64Gb/s FC adapters.
- The Emulex HBA Manager application sees all vPorts created by the driver, but the application has read-only access to them.

3.2.12 Configuring VVols

The Emulex native mode FC driver supports the VVols feature released with ESXi. VMware's VVols feature allows for dynamic provisioning of storage, based upon the needs of a VM. VM disks, also called VVols, allow VMware administrators to manage storage arrays through the API. Arrays are logically partitioned into storage containers. VVols are stored natively in the storage containers. I/O from ESXi to the array is managed through an access point or PE and the storage provider.

3.2.12.1 Storage Containers

Storage containers are a logical abstraction and hold groups of VVols that are physically provisioned in the storage array. Storage containers are an alternative to traditional storage based upon LUNs or NFA shares. Storage containers are set up by a storage administrator. Storage container capacity is based on physical storage capacity. The minimum is one storage container per array, and the maximum number depends upon the array. One storage container can be simultaneously accessed through multiple PEs. When the storage provider and PEs are in place, the storage container is visible to ESXi hosts.

3.2.12.2 Protocol Endpoints

A PE is an access point that enables communication between an ESXi host and a storage array system. A PE is not a datastore; it is the I/O transport mechanism to access the storage container. A PE is part of the physical storage fabric. A PE is created by a storage administrator.

3.2.12.3 Storage Providers

Storage providers are also referred to as VASA providers. Out-of-band communication between vCenter and the storage array is achieved through the storage provider. The storage provider creates the VVols.

For more information about VVols and instructions on configuring VVols, refer to the VMware and target vendor-supplied documentation.

3.2.13 Adjusting the LUN Queue Depth

Inadequate queue depth is one of the reasons for low performance. If you are using VVols and you experience low performance, you might want to adjust the queue depth.

To change the LUN queue depth, perform the following steps:

1. Find the LUN queue depth by typing the following command:

```
/usr/lib/vmware/vmkmgmt_keyval/vmkmgmt_keyval -i vmhba5/Emulex -k param -g | grep lun-queue-depth
```

Information similar to the following is displayed:

```
lun-queue-depth 1 fe 1e 1f      Max number of FCP commands we can queue to a specific LUN
```

where 1f is the queue depth in hexadecimal. Equivalent decimal value is 31.

2. Change the existing queue depth by typing the following command:

```
/usr/lib/vmware/vmkmgmt_keyval/vmkmgmt_keyval -i vmhba5/Emulex -k param -s "lun-queue-depth 0xfe"
```

3. Verify if the queue depth has changed by typing the following command:

```
/usr/lib/vmware/vmkmgmt_keyval/vmkmgmt_keyval -i vmhba5/Emulex -k param -g | grep lun-queue-depth
```

Information similar to the following is displayed:

```
lun-queue-depth 1 fe 1e fe      Max number of FCP commands we can queue to a specific LUN
```

where fe is the new queue depth in hexadecimal. Equivalent decimal value is 254.

4. Get a list of existing LUNs by typing the following command:

```
esxcli storage core device list
```

5. Change the number of outstanding I/Os for each LUN by typing the following command:

```
esxcli storage core device set -d <device name> -m 250 -o 250
```

6. Verify if the number of outstanding I/Os has changed for each specific LUN by typing the following command:

```
esxcli storage core device list -d <device name>
```

The sample output would look like the following:

```
Device Max Queue Depth: 250
No of outstanding IOs with competing worlds: 250
```

3.3 Configuring NVMe over FC on a Target

For instructions on configuring NVMe over FC on a target, contact the target vendor.

3.4 Configuring NVMe over FC on an Initiator System

The following variables are used in the commands provided in this section:

- `<wwpn>` is the WWPN of the HBA.
- `<firmware_filename>` is the name of the firmware file.

To configure NVMe over FC on an initiator system, perform the following steps after the operating system and drivers are installed. For information about updating ESXi drivers, refer to the *Emulex Drivers for VMware ESXi User Guide*. The NVMe driver file name format is `Broadcom-ELX-lpfc_<driver_version>-<OS_version>-<VMware_info>.zip`.

1. Install all applicable VMware components, such as the `elxmgmt` utility.
2. Download the latest firmware for the HBA from the Broadcom® website at www.broadcom.com.
3. Install the firmware on the HBA by typing the following command:

```
esxcli elxmgmt hba firmware download -w <wwpn> -f <firmware_filename>
```

4. Reboot the server.

5. After the server restarts, verify that NVMe adapters were created by typing the following command:

```
esxcfg-scsidevs -a
```

Information similar to the following is displayed:

```
vmhba7 lpfc link-up fc.20000090faf0948f:10000090faf0948f (0000:05:00.0) Emulex Corporation
Emulex LightPulse LPe32000 PCIe Fibre Channel Adapter
vmhba66 lpfc link-up fc.20000090faf0948f:10000090faf0948f (0000:05:00.0) Emulex
Corporation Emulex LightPulse LPe32000 PCIe Fibre
```

6. Verify the connected controller list by typing the following command:

```
esxcli nvme controller list
```

Information similar to the following is displayed:

Name	Controller Number	Adapter	Transport Type	Is Online
-----	-----	-----	-----	-----
-----	-----	-----	-----	-----
nqn.1992-08.com.netapp:sn.54a936ec00ac11ea829d00a0986e444a :subsystem.nvmevs_paramsxi7_ss01#vmhba64#203c00a0986e4449 :203e00a0986e4449	262	vmhba64	FC	true
nqn.1992-08.com.netapp:sn.54a936ec00ac11ea829d00a0986e444a :subsystem.nvmevs_paramsxi7_ss01#vmhba66#203c00a0986e4449 :203e00a0986e4449	264	vmhba66	FC	true
nqn.1992-08.com.netapp:sn.54a936ec00ac11ea829d00a0986e444a :subsystem.nvmevs_paramsxi7_ss01#vmhba67#203c00a0986e4449 :203e00a0986e4449	265	vmhba67	FC	true

```

nqn.1992-08.com.netapp:sn.54a936ec00ac11ea829d00a0986e444a 263      vmhba65 FC      true
:subsystem.nvmevs_paramsxi7_ss01#vmhba65#203c00a0986e4449
:203e00a0986e4449
nqn.1992-08.com.netapp:sn.54a936ec00ac11ea829d00a0986e444a 392      vmhba64 FC      true
:subsystem.nvmevs_paramsxi7_ss01#vmhba64#203c00a0986e4449
:206600a0986e4449
nqn.1992-08.com.netapp:sn.54a936ec00ac11ea829d00a0986e444a 391      vmhba66 FC      true
:subsystem.nvmevs_paramsxi7_ss01#vmhba66#203c00a0986e4449
:206600a0986e4449
nqn.1992-08.com.netapp:sn.54a936ec00ac11ea829d00a0986e444a 393      vmhba65 FC      true
:subsystem.nvmevs_paramsxi7_ss01#vmhba65#203c00a0986e4449
:206600a0986e4449
nqn.1992-08.com.netapp:sn.54a936ec00ac11ea829d00a0986e444a 394      vmhba67 FC      true
:subsystem.nvmevs_paramsxi7_ss01#vmhba67#203c00a0986e4449
:206600a0986e4449

```

7. You can see the connected namespaces by typing the following command:

```
esxcli nvme namespace list
```

Information similar to the following is displayed:

Name	Controller Number	Namespace ID	Block Size	Capacity in MB
uuid.cfb11df2e43a49779293f41319de4fb0	259	1	512	5120
uuid.cfb11df2e43a49779293f41319de4fb1	259	2	512	5120
uuid.cfb11df2e43a49779293f41319de4fb2	259	3	512	5120
uuid.cfb11df2e43a49779293f41319de4fb3	259	4	512	5120
uuid.cfb11df2e43a49779293f41319de4fb4	259	5	512	5120
uuid.cfb11df2e43a49779293f41319de4fb5	259	6	512	5120
uuid.cfb11df2e43a49779293f41319de4fb6	259	7	512	5120
uuid.cfb11df2e43a49779293f41319de4fb7	261	1	512	5120
uuid.cfb11df2e43a49779293f41319de4fb8	259	8	512	102400
uuid.cfb11df2e43a49779293f41319de4fb9	261	2	512	5120
uuid.cfb11df2e43a49779293f41319de4fba	261	3	512	5120
uuid.cfb11df2e43a49779293f41319de4fdb	259	9	512	5120

NOTE: RDM mapping is not supported by NVMe over FC on ESXi 7.0.

You must now create datastores on the NVMe namespaces. To create datastores using the `partedUtil` and `vmkfstools` CLI commands, follow the instructions in [Section 3.4.1, Creating Datastores Using CLI Commands](#). To create datastores using the vSphere Client GUI, go to [Section 3.4.2, Creating Datastores Using the vSphere Client GUI](#).

3.4.1 Creating Datastores Using CLI Commands

The following variables are used in the commands provided in this section:

- `<namespace_name>` is the name of the namespace on which you are creating a datastore, such as `uuid.cfb11df2e43a49779293f41319de4fb0`.
- `<partition_number>` is the number of the partition you are creating.
- `<start_sector>` is the sector at which the partition begins.
- `<end_sector>` is the sector at which the partition ends.
- `<partition_attribute>` identifies the partition properties. This value is usually 0. Refer to the VMware documentation for more information.
- `<datastore_name>` is the name of the datastore you are creating.

To create datastores on the NVMe namespaces using CLI commands, perform the following steps:

1. Label the existing partition table as a GPT by typing the following command:

```
partedUtil mklabel /vmfs/devices/disks/<namespace_name> gpt
```
2. Determine the number of usable sectors that are available for the new partition table by typing the following command:

```
partedUtil getUsableSectors /vmfs/devices/disks/<namespace_name>
```

Information similar to the following is displayed:

```
34 10485726
```
3. Create a new partition table on the disk by typing the following command:

```
partedUtil setptbl /vmfs/devices/disks/<namespace_name> gpt "<partition_number> <start_sector> <end_sector> AA31E02A400F11DB9590000C2911D1B8 <partition_attribute>"
```

NOTE: Use the second value displayed in [Step 2](#) (10485726) as the `<end_sector>` value.
 AA31E02A400F11DB9590000C2911D1B8 is the VMFS datastore partition type in GUID format.

4. Create a VMFS volume and assign a name to the datastore by typing the following command:

```
vmkfstools -C vmfs6 -b 1M -S <datastore_name> /vmfs/devices/disks/<namespace_name>
```

Repeat these steps for each namespace on your server, and then proceed to [Section 3.4.3, Completing the Initiator Configuration](#).

3.4.2 Creating Datastores Using the vSphere Client GUI

To create datastores on the NVMe namespaces using the vSphere Client GUI, perform the following steps:

1. Create a new VMFS by navigating to **Datastores** and clicking **New datastore**. The **Select creation type** dialog of the **New datastore** window appears.

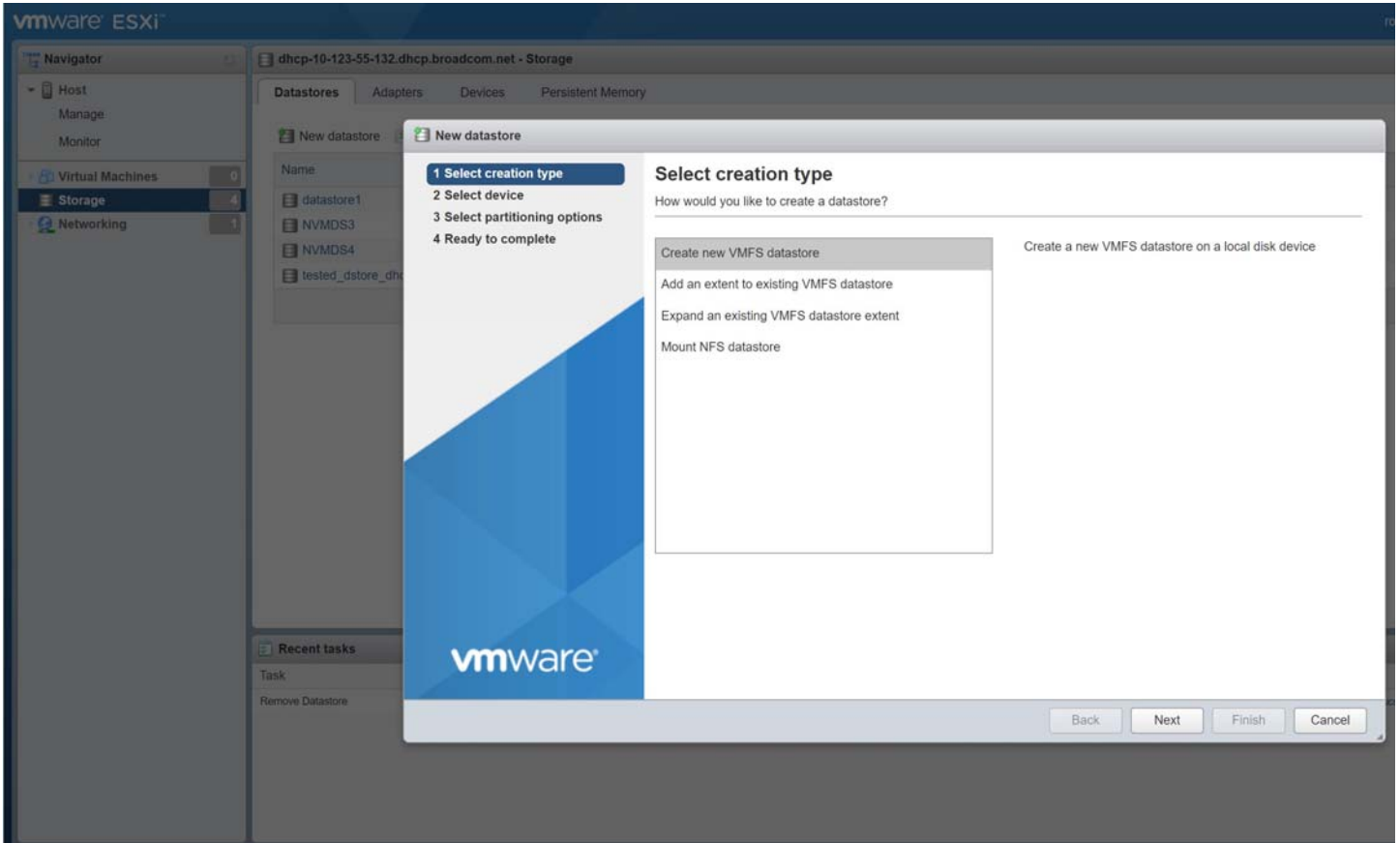

2. Select **Create new VMFS datastore** and click **Next**. The **Select device** dialog appears.

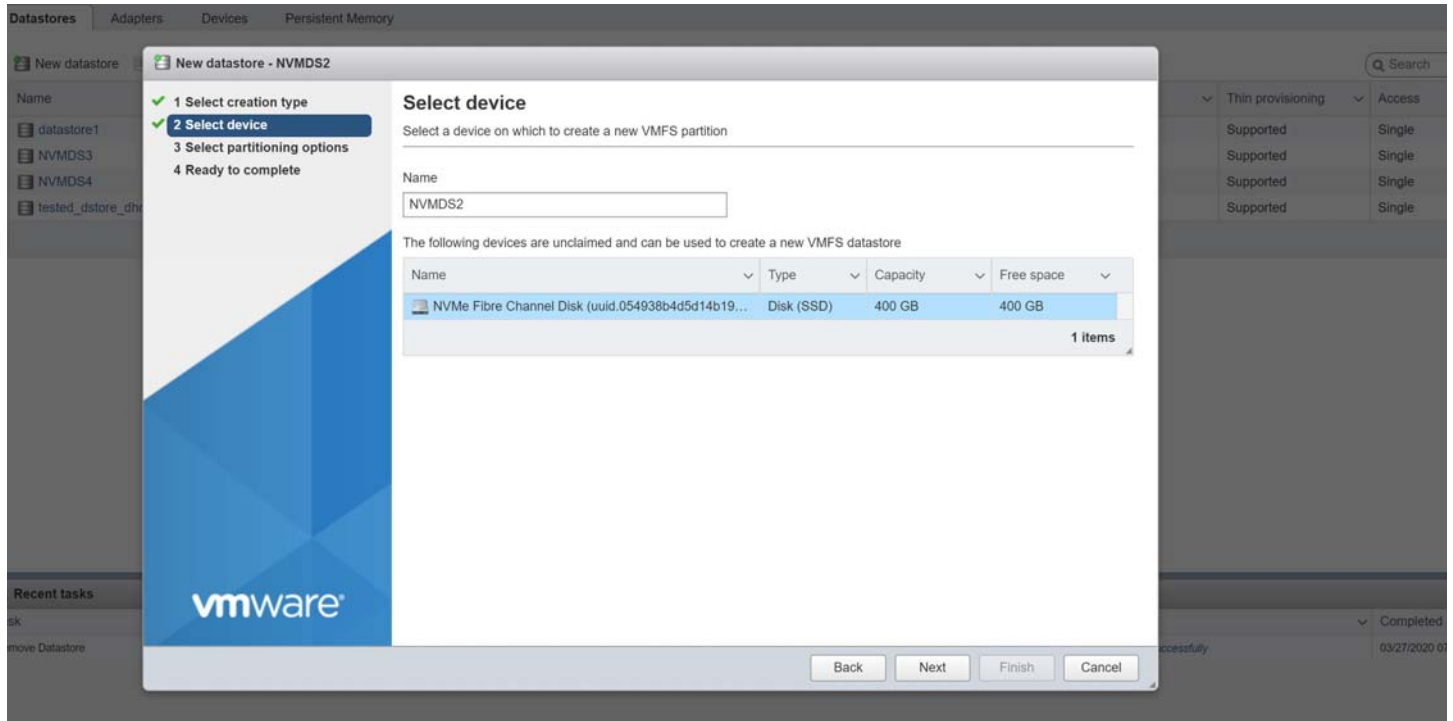

3. In the **Name** field, type the name of the datastore you want to create. Select an unused namespace on which to create the datastore. Click **Next**. The **Select partitioning options** dialog appears.

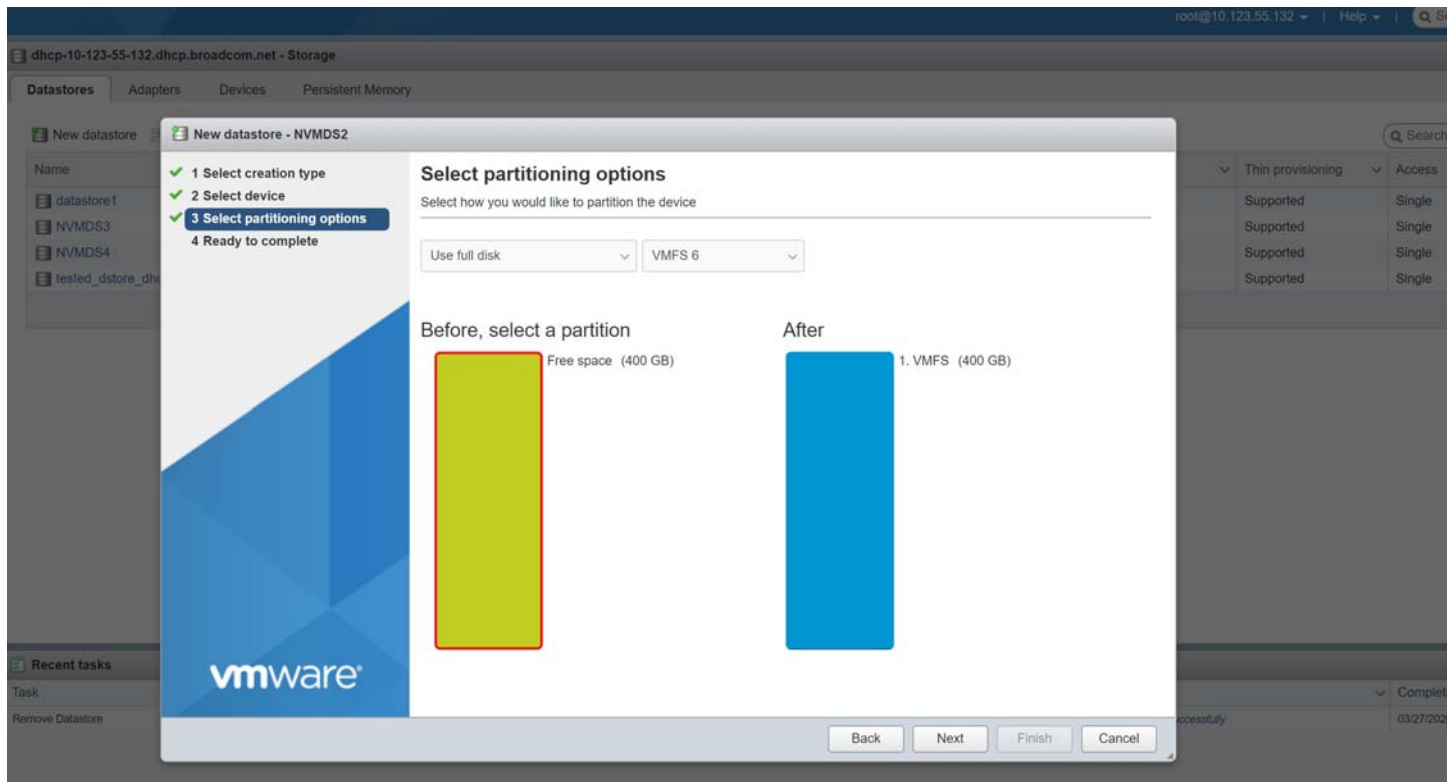

- Select the desired partitioning options and click **Next**. The **Ready to complete** dialog displays information about the selections you have made.

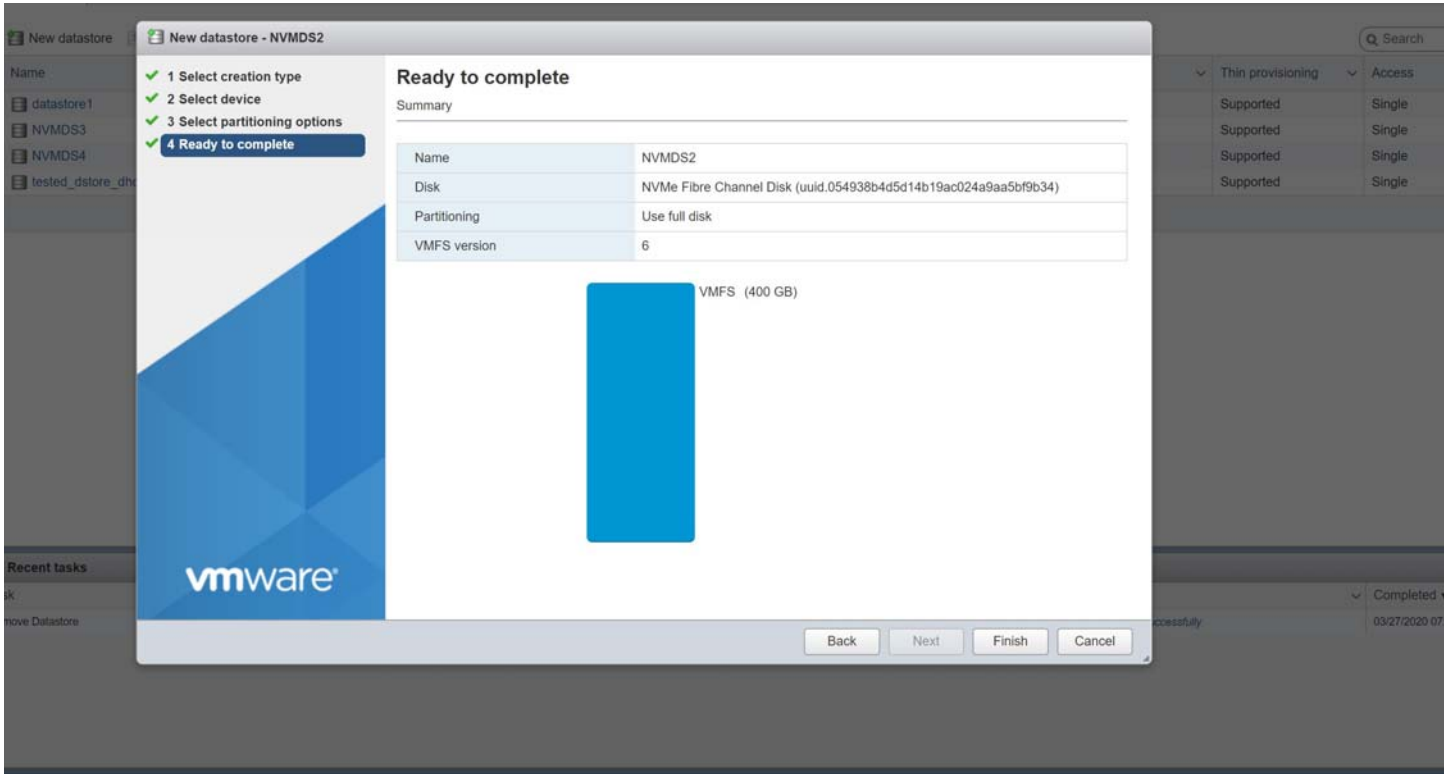

- Click **Finish**. The **Datastores** tab appears.

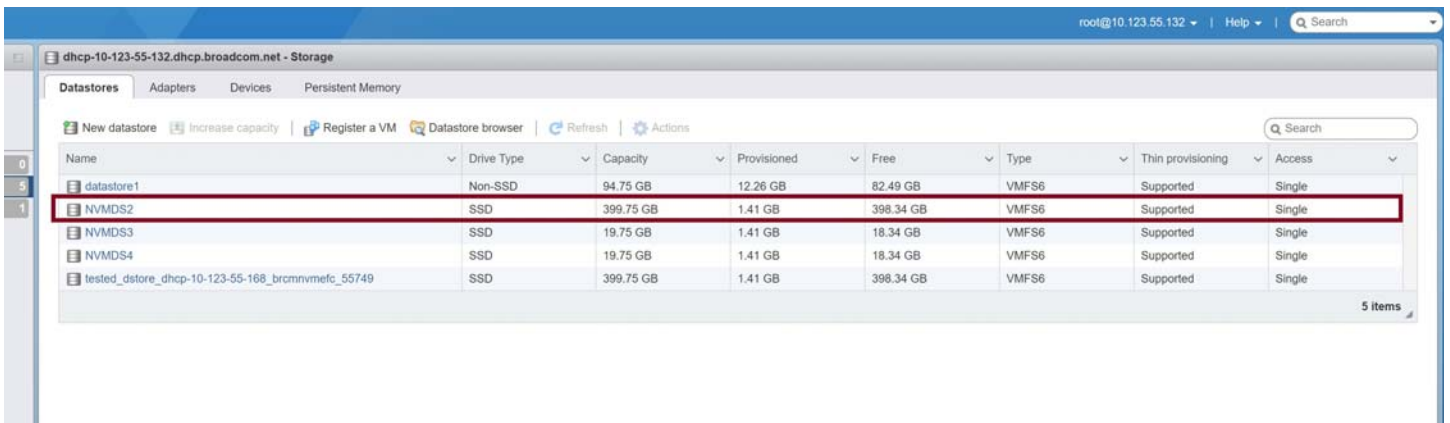

Repeat this procedure for each namespace on your server, and then proceed to [Section 3.4.3, Completing the Initiator Configuration](#).

3.4.3 Completing the Initiator Configuration

Create VMs on the each datastore that you created in [Section 3.4.1, Creating Datastores Using CLI Commands](#) or [Section 3.4.2, Creating Datastores Using the vSphere Client GUI](#). Each VM must have at least four CPUs and 4 GB of memory. Perform the following steps using the vSphere Client GUI:

1. To create a new virtual machine, use the **New Virtual Machine** wizard following the instructions provided by VMware.

NOTE: Create the VM with at least four CPUs and 4 GB of memory.

2. Select a name and a guest operating system for the virtual machine following the instructions provided by VMware. The **Select storage** dialog appears.

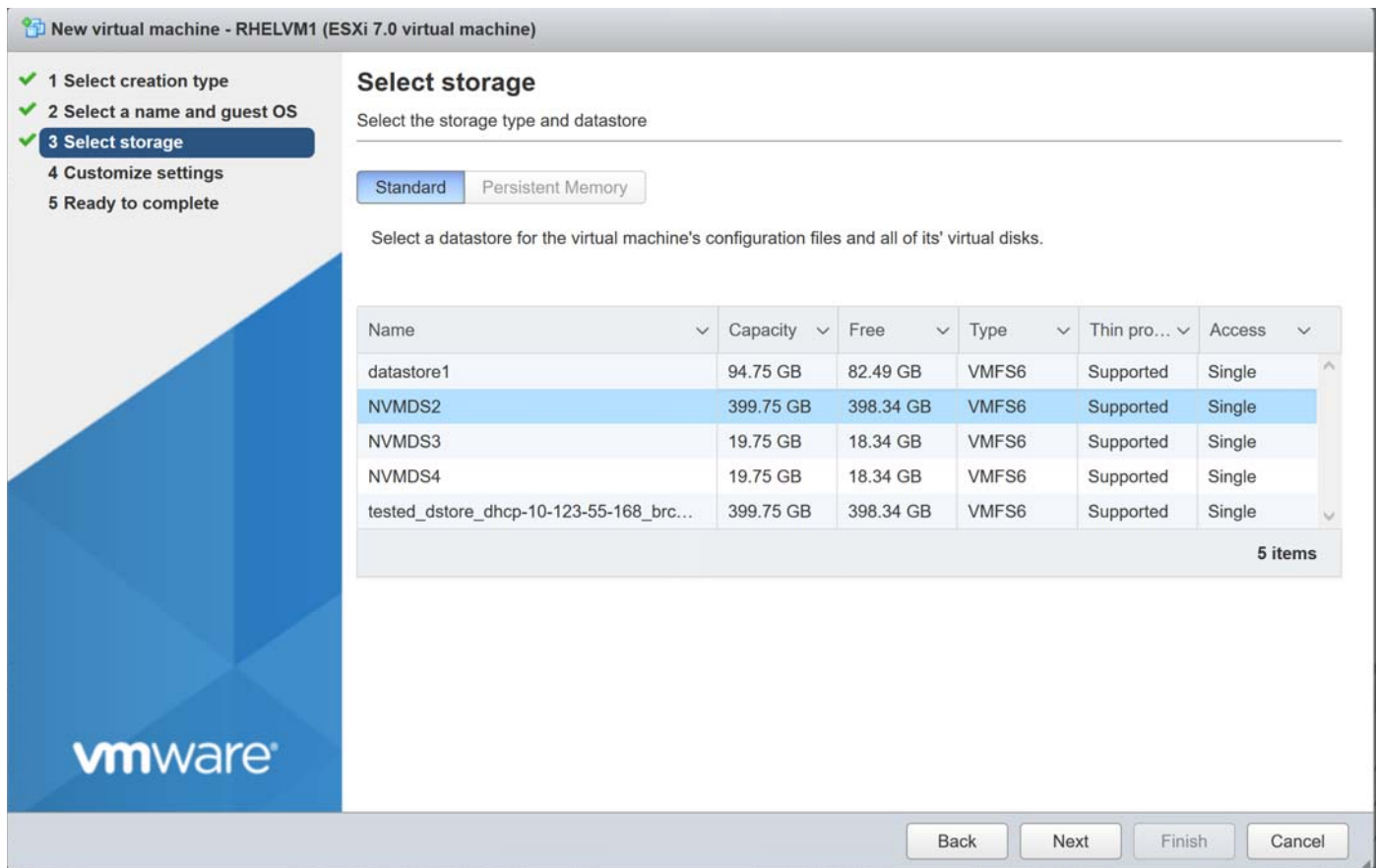

3. Select the datastore on which you want to create the VM and click **Next**. The **Customize settings** dialog appears.

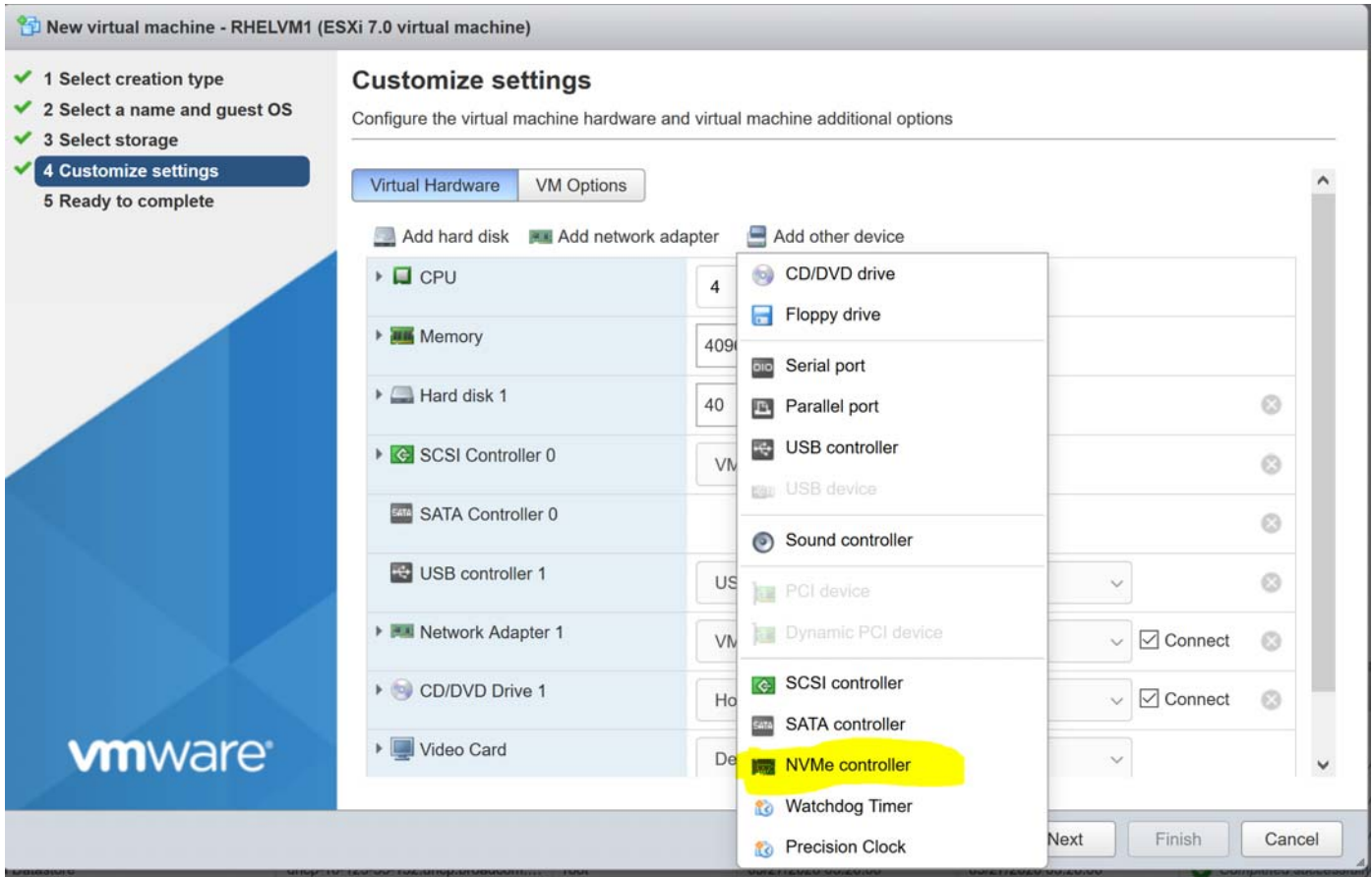

4. Click **Add other device** and select **NVMe controller** to add an NVMe controller on the VM.
5. Click **Add hard disk** to attach the NVMe datastore as a new standard hard disk.

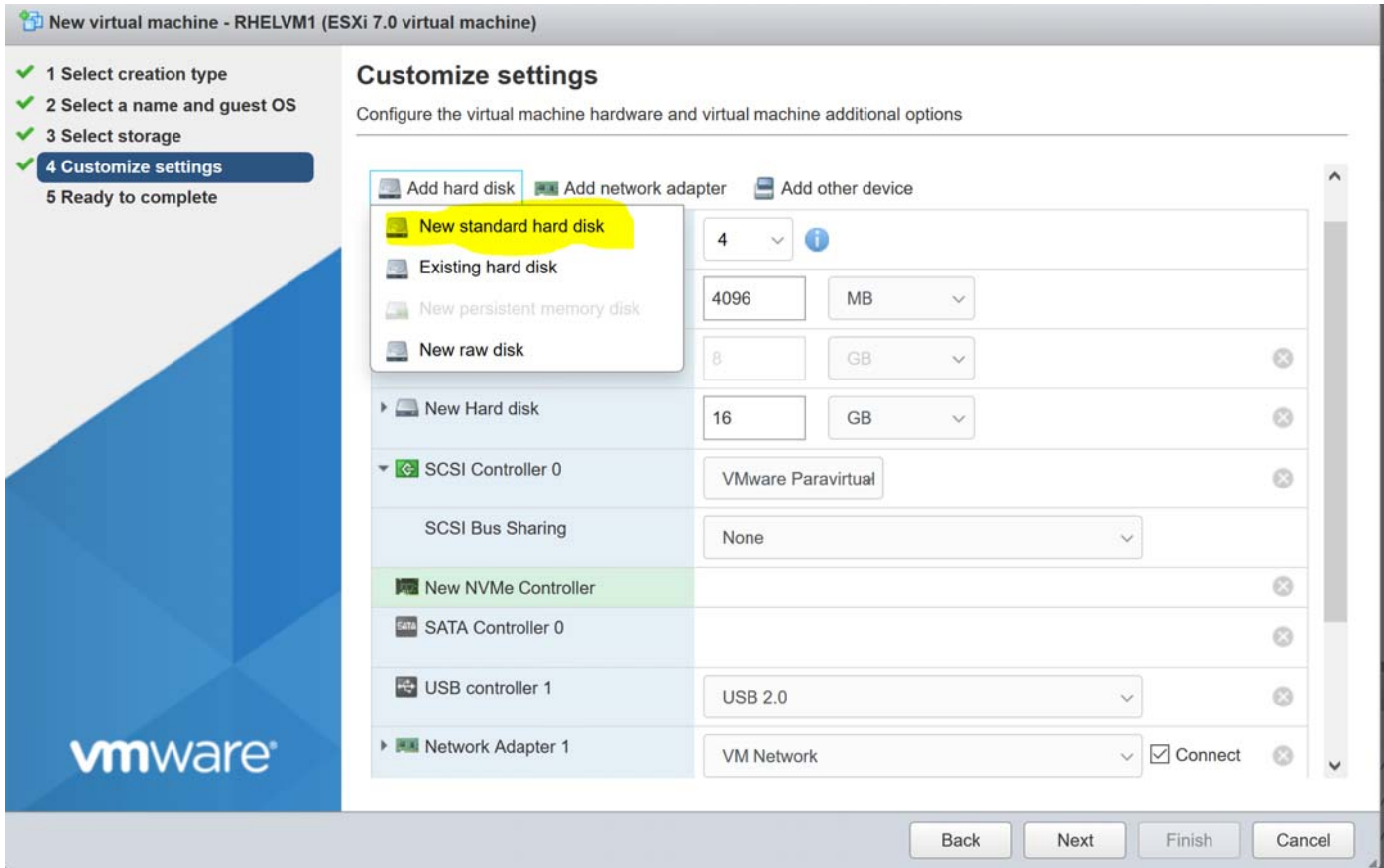

6. Select the NVMe controller on which to attach the new namespace, and click **Next**.

New virtual machine - RHELVM1 (ESXi 7.0 virtual machine)

- ✓ 1 Select creation type
- ✓ 2 Select a name and guest OS
- ✓ 3 Select storage
- ✓ 4 **Customize settings**
- 5 Ready to complete

Customize settings

Configure the virtual machine hardware and virtual machine additional options

Disk Provisioning	<input type="radio"/> Thin provisioned
	<input type="radio"/> Thick provisioned, lazily zeroed
	<input checked="" type="radio"/> Thick provisioned, eagerly zeroed
Shares	Normal <input type="text" value="1000"/>
Limit - IOPs	Unlimited
Controller location	NVMe controller 0 <input type="text" value="NVMe (0:0)"/>
Disk mode	Dependent
Sharing	None
SCSI Controller 0	VMware Paravirtual
SCSI Bus Sharing	None
New NVMe Controller	
SATA Controller 0	

Back Next Finish Cancel

7. Verify your selections, and click **Finish**.

Repeat this procedure for each VM, and power on the VMs. NVMe over FC is configured on the initiator system.

Chapter 4: Troubleshooting the FC Driver

Your system may operate in an unexpected manner in certain circumstances. This chapter explains many of these circumstances and offers one or more workarounds for each situation.

Table 7 identifies some of the common situations and their potential resolutions for the FC driver.

Table 7: Troubleshooting the FC Driver

Situation	Resolution
The port link fails to come up.	<p>If an FC link fails to come up, verify that the adapter is connected to a supported device.</p> <p>The supported 8GFC adapters are:</p> <ul style="list-style-type: none"> ■ 2GFC ■ 4GFC ■ 8GFC <p>The supported 16GFC adapters are:</p> <ul style="list-style-type: none"> ■ 4GFC ■ 8GFC ■ 16GFC <p>The supported 32GFC adapters are:</p> <ul style="list-style-type: none"> ■ 8GFC ■ 16GFC ■ 32GFC
The Emulex driver is not loaded, and all paths are down.	<p>Use the <code>lspci</code> utility to determine whether the Emulex ports are being properly identified. If they are not being properly identified, determine if the driver ISO was correctly installed. You must have the correct driver for the installed adapter because the device PCI IDs are installed with the driver package.</p> <p>Examine the <code>/var/log/vmkernel.log</code> file for <code>lpfc</code> log messages indicating an error. If you specified driver logging (see Section 3.2, FC Driver Configuration), make sure that you spelled the driver parameters correctly. The ESXi module subsystem does not load the driver on reboot if the parameters are not spelled correctly. In this case, contact Broadcom Technical Support.</p>
All paths are down.	<p>Use the driver's KV pages to get critical information.</p> <p>First check the link state. The KV command shown in the footnote shows the driver's current link, and whether it has found a fabric and the link speed.^a</p> <p>If the data shows Link Up Ready and Mode Online, check the discovered nodes. Fabric, initiator, and target types show the SAN as it was presented and discovered by the driver. Additionally, if you are experiencing a periodic path outage, the command shown in the second footnote in a script loop shows if the node status is changing or if the node is going offline.^b</p> <p>If your target or initiator is not in the driver's discovered list, check your zone membership and the state of all zone members.</p> <p>Contact Broadcom Technical Support if you are unable to resolve missing zone members.</p>
The FC driver fails to recognize an adapter and logs unknown IOCB messages in the system log during driver load. The adapter is running outdated firmware.	Download and install the adapter firmware that complies with the minimum supported version (or later) listed on the Broadcom website at www.broadcom.com .
The system panics when booted with a failed adapter installed.	Remove the failed adapter and reboot.

Table 7: Troubleshooting the FC Driver (Continued)

Situation	Resolution
The FC driver does not discover all remote ports in the configuration switch zone. Some initiators or targets may appear to be missing.	<p>Evaluate your switch zone. Count how many entries are there, and add at least seven more (to account for fabric logins). If the sum exceeds 128, you must increase the driver's node table size. The following commands increase it to 200 entries. See Section 3.2, FC Driver Configuration, for more information on this driver parameter.</p> <p>Globally:</p> <pre>esxcli system module parameters set -p lpfc_nlp_slab_cnt=200 -m lpfc</pre> <p>Per instance:</p> <pre>esxcli system module parameters set -p lpfc0_nlp_slab_cnt=200 -m lpfc</pre> <p>A reboot is required.</p>

a. Data from KV command 1:

```
[root@chara:~] /usr/lib/vmware/vmkmgmt_keyval/vmkmgmt_keyval -i vmhba3/Emulex -k adapter -g
Key 'adapter':
lpfc Adapter Page

Emulex LightPulse FC SCSI 14.0.xx.x
Emulex LPe36002-M64 2-Port 64Gb Fibre Channel Adapter on PCI bus 0000:d8 device 00 fn 1 port 1 Logical Link
Speed: 64000 Mbps

BoardNum:      1
FW Version:    14.0.x.x
HW Version:    0000000d
ROM Version:   14.0.x.x
SerialNum:    NP00201308
PCI ID:       10df f400 10df f404

SLI Rev: 4
MQ: Enabled with 4 queues (4)
NPIV Supported: VPIs max 271 VPIs used 0
RPIs max 6144 RPIs used 10 IOCBs inuse 0 IOCB max 20 txq cnt 0 txq max 0 txcmplq 121
XRIs max 6144 FCP 0 Base 6145
FCP SGEs max 67 DMA buf size 4080

Queue Depth
LUN          254
HBA FCP      5894

ABORTs FCP 0 ELS 0: Total 0 - IssueErr 0 Cmpl 0
PCI read error: 0 retry attempts: 0

Supported Speed: 16G 32G 64G
Link Up - Ready:
EDTOV 2000 ms RATOV 10 sec
PortID 0x4e1300
Fabric
Current speed 64G

WWPN 10:00:00:90:fa:94:94:65 WWNN 20:00:00:90:fa:94:94:65

Mode: Online

Interrupt Type: MSIX
BlockGuard Disabled
External DIF Enabled

BBCredit Recovery Supported
BBSCN default:8 min:1 max:15
```

b. Data from KV command 2:

```
[root@chara:~] /usr/lib/vmware/vmkmgmt_keyval/vmkmgmt_keyval -i vmhball/Emulex -k node -g
Key 'node':
lpfc Node page:
```

WWNN	WWPN	ScsiID	DID	Type	Status
10:00:00:05:33:a6:a8:bb	20:06:00:05:33:a6:a8:bb		xxxxffe	Fabric	Node ok
10:00:00:05:33:a6:a8:bb	21:fc:00:05:33:a6:a8:bb		xxxxffc	Fabric	Node ok
00:00:00:00:00:00:00:00	00:00:00:00:00:00:00:00		xxxxffd	Fabric	Node logged out
20:00:00:00:c9:f3:f9:b6	10:00:00:00:c9:f3:f9:b6		x021600	Initiator	Node ok
20:00:00:00:c9:f4:48:af	10:00:00:00:c9:f4:48:af		x020700	Initiator	Node ok
20:00:00:90:fa:02:19:16	10:00:00:90:fa:02:19:16		x021500	Initiator	Node ok
20:00:00:90:fa:02:19:17	10:00:00:90:fa:02:19:17		x020e00	Initiator	Node ok
20:00:00:90:fa:5d:2f:29	10:00:00:90:fa:5d:2f:29		x020902	Initiator	Node ok
20:00:00:90:fa:5d:2f:31	10:00:00:90:fa:5d:2f:31		x020903	Initiator	Node ok
20:00:00:90:fa:5d:92:2f	10:00:00:90:fa:5d:92:2f		x02094a	Initiator	Node ok
20:00:00:11:0d:e0:54:00	20:00:00:11:0d:e0:54:00	0	x02090e	Target	Node ok
20:06:00:11:0d:19:9a:00	20:06:00:11:0d:19:9a:00	1	x021000	Target	Node ok
20:07:00:11:0d:19:9b:00	20:07:00:11:0d:19:9b:00	2	x021100	Target	Node ok

4.1 FC Driver Log Messages

Log messages have traditionally been organized into logical groups based on code functionality in the FC driver. With the introduction of the latest Emulex adapters, that grouping is modified to account for additional behaviors. The traditional grouping is maintained, but recently added messages are no longer grouped together.

The messages provided in this section are unmaskable error conditions. They are automatically added to the system console log.

You can examine the `/var/log/vmkernel.log` file to view any of these messages. If you have concerns, run a `vm-support dump` and contact VMware or Broadcom Technical Support.

Log messages are organized into logical groups based on code functionality within the driver. Each group consists of a block of 100 log message numbers. Most groups require a single block of 100 message numbers; however, some groups (INIT, FCP) require two blocks.

[Table 8](#) lists the groups and defines the associated number ranges.

Table 8: Message Log Table

LOG Message Verbose Mask Definition	Verbose Bit	Verbose Description
LOG_ELS	0x00000001	Extended Link Service events
LOG_DISCOVERY	0x00000002	Link discovery events
LOG_MBOX	0x00000004	Mailbox events
LOG_INIT	0x00000008	Initialization events
LOG_LINK_EVENT	0x00000010	Link events
LOG_MGMT_ERROR	0x00000020	IODM management error logging
LOG_FCP	0x00000040	FCP traffic history
LOG_NODE	0x00000080	Node table events
LOG_BG	0x00000200	BlockGuard events
LOG_MEM_HEAP	0x00000400	Memory tracker heap logging
LOG_SLI	0x00000800	SLI™ events

Table 8: Message Log Table (Continued)

LOG Message Verbose Mask Definition	Verbose Bit	Verbose Description
LOG_FCP_ERROR	0x00001000	Log errors, not underruns
LOG_LIBDFC	0x00002000	Libdfc events
LOG_VPORT	0x00004000	NPIV events
LOG_MEM_SLAB	0x00008000	Memory tracker slab logging
LOG_EVENT	0x00010000	Common transport, TEMP, DUMP, logging
LOG_AUTH	0x00020000	DH-CHAP logging
LOG_FCP_UNDER	0x00040000	FCP underruns errors
LOG_TASKMGMT	0x00100000	Task management events
LOG_MGMT	0x00200000	IODM management trace logging
LOG_SCSI_CMD	0x00400000	ALL SCSI commands
LOG_EDIF	0x00800000	External DIF events
LOG_ESXCLI	0x04000000	Log esxcli messages
LOG_ALL_MSG	0x7ffffff	Log all messages

The following is an example of a LOG message:

```
lpfc_sli4_read_config:8989: 0:2003 cfg params Extents
```

In the preceding LOG message:

- `lpfc` – Identifies the driver binary
- `sli4_read_config` – Identifies the function generating the log
- `0` – Identifies the Emulex port number
- `2003` – Identifies the LOG message number

NOTE: If the word *Data:* is present in a LOG message, any information to the right of *Data:* is intended for Broadcom Technical Support or Engineering use only.

Unless otherwise noted in the ACTION: attribute, report these errors to Broadcom Technical Support. Broadcom requests that when reporting occurrences of these error messages, you provide a tarball of all vmkernel files in `/var/log`.

4.2 FC Driver Error Log Messages and Their Descriptions

```
3031 Delay authentication for <seconds>
```

Authentication is delayed because there is a fabric change.

ACTION: No action required.

```
3642 Read Object mailbox cmd failed with <status> <add_status> <mbx_status> <shdr_status>
<shdr_add_status> <mb_sts>
```

Authentication read from the flash memory failed.

ACTION: Upgrade the firmware or report the error to Broadcom Technical Support.

```
3088 Read Object abnormal exit <rc>
```

No authentication configured.

ACTION: Need to configure authentication. Refer to the *Emulex Drivers for VMware ESXi User Guide* for instructions.

3042 No Authentication configuration found for request

No authentication configured.

ACTION: Need to configure authentication, Refer to the *Emulex Drivers for VMware ESXi User Guide* for instructions.

0264 FDMI cmdcode <cmdcode> not supported

Driver sends an invalid FDMI command.

ACTION: Report the error to Broadcom Technical Support.

0257 GID_FT Query error <ulpStatus> <Reason code> retries <fc_ns_retry>

GID_FT to the NameServer is failing, and this can cause target discovery.

ACTION: Check the port connection and the switch configuration.

0267 NameServer GFF Rsp <DID> Error <Status> <Reason code> Data <fc_flag> <fc_rscn_id_cnt>"

GFF to the NameServer is failing, and this can cause target discovery.

ACTION: Check the port connection and the switch configuration.

6435 E2E FDMI RPA failure

An FDMI command to the management server is failing for end-to-end management feature.

ACTION: Switch may not support end-to-end management support. Upgrade the switch or report the error to Broadcom Technical Support.

4927 Failed Mbuf Alloc cnt <size> <index>

Failed to allocate DMA buffer.

ACTION: Check the ESX host configuration and memory usage to free up some resources.

5941 Failed Heap Alloc of DMABuf, cnt <count> i <index>

Failed to allocate DMA buffer.

ACTION: Check the ESX host configuration and memory usage to free up some resources.

4673 UNSOL CT Rsp err <rc> Data: <fc_flag>

Unable to reject unhandled end-to-end management commands.

ACTION: No action required.

0241 NameServer Rsp Error Data .<CmdRsp> <ReasonCode> <Explanation> <fc_flag>

GID_FT to the NameServer is failing.

ACTION: Check the port connection and the switch configuration.

0268 NS cmd <cmdcode> Error <ulpStatus><Reason code>

Common transport command is failing with error status.

ACTION: Check the port connection and the switch configuration.

0266 Issue NameServer Req <cmdcode> err <rc> Data: <fc_flag> <fc_rscn_id_cnt>

Failed to issue command to NameServer.

ACTION: Check the port connection and the switch configuration.

7902 Failed to alloc CT RSP for DID <DID> size <rsp_size> cmd <cmdcode>

Failed to allocate memory for the Common transport command.

ACTION: Check the ESX host configuration and memory usage to free up some resources.

9021 Failed to issue IOCB

Failed to issue IOCB command to the firmware.

ACTION: Report the error to Broadcom Technical Support.

7062 VMID cmdcode <cmdcode> not supported

Invalid VMID Common transport command.

ACTION: Report the error to Broadcom Technical Support.

7157 Failed Gen_Req status <status>

Failed to send the Common transport command.

ACTION: Check the port connection and the switch configuration.

3056 set not supported - Persistent topology settings in place.

Cannot change topology; persistent topology is enabled.

ACTION: No action required.

2699 Misconfigured FA-WWN - Attached device does not support FA-WWN

The HBA port is configured to use FA-WWN, but the attached device does not support it.

ACTION: Report the error to Broadcom Technical Support.

3177 EEPROM failure - Event Data1: <event_data1> Event Data2: <event_data2>

EEPROM failure occurred on the HBA.

ACTION: No action required.

2019 FW does not support persistent topology Using driver parameter defined value <topology>

The firmware does not support persistent topology, using driver parameter defined value.

ACTION: No action required.

2021 Invalid topology values from FW Using driver parameter defined value <>

Invalid topology values from firmware, using driver parameter defined value.

ACTION: No action required.

4202 EDC rsp error - sending RDF for FPIN only.

Exchange Diagnostic Capabilities (EDC) response error, using RDF for FPIN.

ACTION: No action required.

4919 Unknown Desc Tag <tag>

Unknown Exchange Diagnostic Capabilities (EDC) descriptor tag.

ACTION: Report the error to Broadcom Technical Support.

4657 FPIN CONGESTION <Notification> type <FPIN_TYPE> (<type>) Event Duration <evt_period> mSecs

Lost Credit and Credit Stall and driver recovering.

ACTION: Check the port connection and the switch configuration.

2516 CGN SET_FEATURE mbox failed with status <shdr_status> add_status <shdr_add_status>, mbox status <mbxStatus> Reset Congestion to FPINS only

Enable Congestion SIGNAL feature in firmware is failing.

ACTION: Report the error to Broadcom Technical Support.

0136: PLOGI completes to NPort <DID> completion
PLOGI completes to N_Port completion.
ACTION: No action required.

0137: No retry ELS command <ELS_CMD> to remote
No retry Extended Link Service command is sent to remote node.
ACTION: No action required.

0237: Pending Link Event during Discovery: State <hba_state>
Received link event during discovery. Causes discovery restart.
ACTION: No action required, unless this issue persists. If persistent, check cabling.

4678: Unknown FPIN <descriptor tag> - Reject
Unknown FPIN descriptor tag.
ACTION: No action required.

0034 Unable to send mailbox
Either the driver could not allocate resources, or it could not send sparam_mbox or cfglink_mbox.
ACTION: Attempt to unload and reload the driver when it is convenient.

0127: ELS timeout
An Extended Link Service IOCB command was posted to a ring and did not complete within ULP timeout period.
ACTION: If no Extended Link Service command is going through the adapter, reboot the system. If this issue persists, contact Broadcom Technical Support.

2858 FLOGI failure
The fabric rejected an FLOGI.
ACTION: Reconfigure the switch and check connection. If this issue persists, contact Broadcom Technical Support.

0125: FDISC Failed <Reject Error>. Fabric out of resources
The fabric rejected an FDISC because the switch cannot support additional virtual ports.
ACTION: Reconfigure the switch to support more NPIV logins. If this issue persists, contact Broadcom Technical Support.

0125: FDISC Failed <Reject Error>. Fabric Detected Bad WWN
The fabric rejected an FDISC because the switch detected a bad WWN.
ACTION: No action required.

2851 Attempt link reset
A link reset is being attempted.
ACTION: No action required.

0138: ELS rsp: Cannot issue reg_login for <DID>
REG_LOGIN mailbox command failed.
ACTION: Ensure the adapter firmware is current. Reload the driver.

2853 Failed to issue INIT_LINK mbox command
The mailbox command to enable an asynchronous event notification failed.
ACTION: Ensure the adapter firmware is current. Reload the driver.

2852 Failed to allocate mbox memory

Mailbox allocation error.

ACTION: No action required

3334 Delay fc port discovery for <n> seconds

Delay the node port discovery since fabric parameters changed.

ACTION: No action required.

2556: UNREG_VFI mbox allocation failed HBA state <port_state>

Could not allocate memory for UNREG_VFI mailbox command.

ACTION: No action required.

2557: UNREG_VFI issue mbox failed rc <rc> HBA state <port_state>

Could not issue the UNREG_VFI mailbox command.

ACTION: No action required.

0113: An FLOGI ELS command <elsCmd> was received from DID <did> in Loop Mode

While in Loop Mode, an unknown or unsupported Extended Link Service command was received.

ACTION: Check device DID.

0111 Dropping received ELS cmd

The driver decided to drop an Extended Link Service response ring entry.

ACTION: This error could indicate a software driver or firmware issue. If this issue persists, report the error to Broadcom Technical Support.

0115: Unknown ELS command <elsCmd> received from NPORT <did>

Received an unsupported Extended Link Service command from a remote N_Port.

ACTION: Check the remote N_Port for a potential issue.

0289: Issue Register VFI failed <ret_val>

The driver could not register the virtual fabric index for the Fibre Channel Forwarder Indicator (FCFI).

ACTION: Check the switch and port configurations.

0915 Register VPI failed : Status: <stauts> upd bit <upd_bit value>

Could not register the VPI.

ACTION: No action required.

2881: RRQ failure DID:<did> Status:<status_value>

A driver Reinstate Recovery Qualifier request failed.

ACTION: This is a software driver error. If this issue persists, report the error to Broadcom Technical Support.

4110 Issue PLOGI <deferred_did> deferred on NPort <d_id> rpi <rpi> Data: <ndlp_ptr>

Defer the processing of issue PLOGI until outstanding UNREG_RPI mailbox completes.

ACTION: No action required.

2831 FLOGI response with cleared Fabric bit fcf_index <fcf_index> Switch Name <switch_name> Fabric Name <fabric_name>

When the driver completed an FLOGI, the common service parameters did not indicate an F_Port or N_Port remote node. The driver treats this issue as an error.

ACTION: Validate the external cable connection and F_Port/N_Port configuration. If this issue persists, report the error to Broadcom Technical Support.

3094 Start rport recovery on adapter id <adapter_hostnum> fc_id <d_id> vpi <vpi> rpi <rpi> xri <xri> state <node_state> flags <node_flags>

Recover a port that failed a BLS abort sequence request.

ACTION: Check the remote N_Port. The driver would issue LOGOUT to the remote N_Port as part of the recovery process.

2882: RRQ completes to N_Port <value> with no ndlp. Data: <status> <reason> <iotag>

The driver completes a Reinstatement Recovery Qualifier, but no node association exists.

ACTION: This is a software driver error. If this issue persists, report the error to Broadcom Technical Support.

0348: NameServer login: node freed

The enable mode failed to free up the NameServer login.

ACTION: No action required.

4532 UVEM LS_RJT <data 0> <data1>

VMID UVEM got an LS reject.

ACTION: Check switch configuration.

4533 UVEM error status <ulpStatus> <ulpWord>

VMID UVEM got an error.

ACTION: Check switch configuration.

0249: Cannot issue Register Fabric login: Err <err>

The firmware could not issue the fabric REG_LOGIN command; the error value is unique for each possible failure.

ACTION: This is a software driver error. If this issue persists, report the error to Broadcom Technical Support.

6529 QFPA failed with status %x %x , irsp->ulpStatus, irsp->un.ulpWord[4]);

VMID QFPA got an LS reject.

ACTION: Check switch configuration.

6528 QFPA LS_RJT %x %x , data[0], data[1]);

VMID QFPA got an error.

ACTION: Check switch configuration.

0649 Cannot issue Register Fabric login: Err <err>

The firmware could not issue the fabric REG_LOGIN command for SLI4 adapter. The error value is unique for each possible failure.

ACTION: This is a software driver error. Report the error to Broadcom Technical Support.

2756: LOGO failure DID:<DID> Status:<Status>/<Extended Status>.

An N_Port logout to DID failed either by the driver, the firmware, or the target. The status and extended status indicate why the N_Port logout failed.

ACTION: Check the remote N_Port functionality. If the issue persists, report the error to Broadcom Technical Support.

2754: PRLI failure DID:<DID> Status:<Status>/<Extended Status>.

A process login to DID failed either by the driver, the firmware, or the target. The status and extended status indicate why the process login failed.

ACTION: Check the remote N_Port functionality. If the issue persists, report the error to Broadcom Technical Support.

2755: ADISC failure DID:<DID> Status:<Status>/<Extended Status>.

An address discovery to DID failed either by the driver, the firmware, or the target. The status and extended status indicate why the address discovery failed.

ACTION: If the issue persists, report the error to Broadcom Technical Support.

2753: PLOGI failure DID:<DID> Status:<Status>/<Extended Status>.

A port login to DID was failed either by the driver, the firmware, or the target. The status and extended status indicate why the port login failed.

ACTION: Check the remote N_Port functionality. If the issue persists, report the error to Broadcom Technical Support.

2732: Failed to issue INIT_VPI mailbox command.

The driver wanted to send an INIT_VPI mailbox command to initialize a vPort, but it failed to send the mailbox command due to the state of the adapter.

ACTION: No action required.

0126: FDISC failed (ulpStatus/ulpWord[4])

The Extended Link Service F_Port discovery command has failed.

ACTION: Check the port and switch configuration.

0255: Issue FDISC: no IOCB

All of the pre-allocated IOCBs are in use.

ACTION: No action required.

0254 Register VPI: no memory);

Out of memory while registering vPort.

ACTION: No action required.

0256 Issue FDISC: Cannot send IOCB);

Unable to issue a fabric IOCB command.

ACTION: No action required.

0251 NameServer login: no memory);

Memory allocation failed during PLOGI.

ACTION: No action required.

0253 Register VPI: Can't send mbox);

Unable to send mailbox command while registering a new VPort with the HBA.

ACTION: No action required.

0252 Cannot issue NameServer login);

Memory allocation failed during PLOGI.

ACTION: No action required.

7105 failed to allocate mailbox memory);
Memory allocation for mailbox failed.
ACTION: No action required.

0820 FLOGI Failed <lsRejErr> BBCredit Not Supported
An FLOGI failed because the other endpoint was not ready/busy.
ACTION: No action required.

1305 Link Down Event <Event_Tag> received Data: <fc_event_tag> <port_state> <flags>
Link down event was received.
ACTION: Check the connectivity between the fabric nodes.

1306 Link Up Event in loop back mode <event_tag> received Data: <fc_event_tag> <flags>
Link up event in the loopback mode was received.
ACTION: No action required.

1303 Link Up Event <event_tag> received Data: <fc_event_tag> <flags>
Link up event was received.
ACTION: No action required.

0231 RSCN timeout Data: <fc_ns_retry> <LPFC_MAX_NS_RETRY>
RSCN timeout occurred during discovery.

ACTION: This error could indicate a software driver or firmware issue. If this issue persists, report the error to Broadcom Technical Support.

0230 Unexpected timeout, hba link state <link_state>
Unexpected timeout occurred during discovery.

ACTION: This error could indicate a software driver or firmware issue. If this issue persists, report the error to Broadcom Technical Support.

0545 lpfc_create_static_vport bad information header <signature> <rev>
Invalid header fields while creating vPort.

ACTION: This error could indicate a software driver or firmware issue. If this issue persists, report the error to Broadcom Technical Support.

2524 Failed to get the non-embedded SGE virtual address
Unable to obtain correct non-embedded SGE virtual address.

ACTION: This error could indicate a software driver or firmware issue. If this issue persists, report the error to Broadcom Technical Support.

0546 lpfc_create_static_vport failed to create vport <status> <wwpn> < wwnn>
Failed to create vport.

ACTION: This error could indicate a software driver or firmware issue. If this issue persists, report the error to Broadcom Technical Support.

1836 Could not issue unreg_login(all_rpis) <status>
Could not issue unreg login.

ACTION: No action required.

0543 lpfc_create_static_vport failed to allocate vport_info);
Out of memory while allocating vPort information.

ACTION: No action required.

0542 lpfc_create_static_vport failed to allocate mailbox memory);
Out of memory while allocating mailbox command for vPort information.
ACTION: No action required.

2018 REG_VFI mbxStatus error x<status> HBA state x<Portstate>
Mailbox command returned error.
ACTION: This error could indicate a software driver or firmware issue. If this issue persists, report the error to Broadcom Technical Support.

0306 CONFIG_LINK mbxStatus error x<Status> HBA state x<Portstate>
Mailbox command returned error.
ACTION: This error could indicate a software driver or firmware issue. If this issue persists, report the error to Broadcom Technical Support.

2017 REG_FCFI mbxStatus error x<Status> HBA state x<Portstate>
Mailbox command for registering FCF returned error.
ACTION: This error could indicate a software driver or firmware issue. If this issue persists, report the error to Broadcom Technical Support.

2013 Could not manually add FCF record 0, status <Status>

1313 Link Down UNEXP WWPN Event x<EventTag> received Data: x<FC EventTag> x<Portstate> x<Flags>
Unexpected WWPN during read topology. Link down.
ACTION: Check the connectivity between the fabric nodes.

1308 Link Down Event in loop back mode <eventTag> received Data: <fc_eventTag> <port_state> <fc_flag>
Link down event occurred in loopback mode.
ACTION: No action required.

1309 Link Up Event npiv not supported in loop topology
NPIV is not supported in loop topology.
ACTION: No action required.

3403 Created Static Vport <vport> with port type <port_type> and vport_flag <vport_flag>
The vPort creation for static port failed.
ACTION: No action required.

2553 lpfc_unregister_unused_fcf failed to read FCF record HBA state <port_state>
Failed to read FCF records.
ACTION: No action required.

2550 UNREG_FCFI mbxStatus error <mbxStatus> HBA state <port_state>
The UNREG_FCFI mailbox command failed.
ACTION: No action required.

2551 UNREG_FCFI mbox allocation failed HBA state <port_state>
The allocation for the UNREG_FCFI mailbox command failed.
ACTION: No action required.

2552 Unregister FCFI command failed rc <rc> HBA state <port_state>
The UNREG_FCFI mailbox command failed.
ACTION: No action required.

2554 Could not allocate memory for fcf record
The memory allocation to store fcf_record failed.
ACTION: No action required.

2555 UNREG_VFI mbxStatus error <mbxStatus> HBA state <port_state>
The UNREG_VFI mailbox command failed.
ACTION: No action required.

2798 Unreg_vpi failed vpi <vpi> mb status <mbxStatus>
The UNREG_VPI mailbox command failed.
ACTION: No action required.

3274 ScsiNotifyPathStateChangeAsync SAdapter Num <hostNum> TID <nlp_sid>, DID <nlp_DID>.
Notified the VMkernel about the path state change successfully.
ACTION: No action required.

3275 ScsiNotifyPathStateChangeAsync Failed: <rc> SAdapter Num <hostNum> TID <nlp_sid>, DID <nlp_DID>.
Failure in notifying the VMkernel about the path state change.
ACTION: No action required.

3303 Failed to obtain vport vpi
Failed to get a VPI resource for the vPort.
ACTION: No action required.

3278 No SID assigned for port type <port_type> vpi <vpi>
SCSI ID is not assigned for node belongs to this type of vPort.
ACTION: No action required.

0320 CLEAR_LA mbxStatus error <mbxStatus> hba state <port_state>
The driver issued a CLEAR_LA mailbox command to the HBA that failed.
ACTION: This error could indicate a firmware or hardware issue. Report the error to Broadcom Technical Support.

0206 Device Discovery completion error
This indicates that an uncorrectable error was encountered during device discovery after a link-up. FC devices will not be accessible if this message is displayed.
ACTION: Reboot the system. If this issue persists, report the error to Broadcom Technical Support. Run with verbose mode enabled for more information.

0203 Devloss timeout on WWPN <wwpn> NPort <nlp_DID> Data: <nlp_flag> <nlp_state> <nlp_rpi>
A remote N_Port that was discovered by the driver disappeared for more than lpfc_devloss_tmo seconds.
ACTION: If the device generating this message is not a target to which the HBA is connected, this error will not affect the data integrity of the I/O between the HBA and the attached storage and can be ignored.

0200 CONFIG_LINK bad hba state <port_state>

A CONFIG_LINK mailbox command completed, and the driver was not in the right state.

ACTION: Software driver error. If this issue persists, report the error to Broadcom Technical Support.

Reboot the system. If this issue persists, report the error to Broadcom Technical Support. Run with verbose mode enabled for more information.

2606 No NPIV Fabric support

The fabric does not support NPIV port.

ACTION: No action required.

2607 Failed to allocate init_vpi mailbox

The adapter failed to allocate the init_vpi mailbox command.

ACTION: No action required.

0260 Register NameServer error: <mbxStatus>

The REG_LOGIN mailbox command has failed for the NameServer.

ACTION: If the issue persists, report the error to Broadcom Technical Support.

0263 Discovery Mailbox error: state: <port_state> : <sparam_mbox> <cfglink_mbox>

Either the driver could not allocate resources, or it could not send the sparam_mbox or cfglink_mbox command.

ACTION: Attempt to unload and reload the driver when it is convenient.

2936 Could not find Vport mapped to vpi <vpi>

The VPI to vPort mapping is not found.

ACTION: No action required.

2608 Failed to issue init_vpi mailbox

The driver was unable to send an INIT_VPI mailbox command.

ACTION: No action required.

2609 Init VPI mailbox failed <mbxStatus>

The INIT_VPI mailbox command sent to firmware failed.

ACTION: No action required.

2765 Mailbox command READ_FCF_RECORD failed to retrieve a FCF record

The READ_FCF_RECORD mailbox command failed to provide any FCF record.

ACTION: No action required.

2521 READ_FCF_RECORD mailbox failed with status <shdr_status> add_status <shdr_add_status>

The READ_FCF_RECORD mailbox command sent to firmware is failed.

ACTION: No action required.

3314 Toplogy changed was <fc_topolgy> is <la>

The FC topology of the port changed.

ACTION: No action required.

9733 CT Request to NS failed

Cannot issue NameServer query.

ACTION: Report the error to Broadcom Technical Support.

0273 Unexpected discovery timeout, vport State <port_state>

The discovery process has timed out.

ACTION: Verify that all targets are still visible. If not, report the error to Broadcom Technical Support.

3298 ScsiNotifyPathStateChangeAsync SAdapter Num <sadapter number> TID <scsi id> DID <fc did>
Path change notification is successful.
ACTION: No action required.

3299 ScsiNotifyPathStateChangeAsync Failed: <return code> SAdapter Num <sadapter number> TID<scsi id>,
DID <fc did>
Path change notification has failed.
ACTION: Report the error to Broadcom Technical Support.

0258 Register Fabric login error: <mailbox status>
The REG_LOGIN for the fabric failed.
ACTION: Check the port connection and the switch configuration.

2568 Config region 23 has bad version
Failure to read Config Region 23 - invalid version.
ACTION: No action required.

2884 Vport array allocation failed
vPort array memory allocation failure.
ACTION: Reload driver or reboot. If issue persists, report the error to Broadcom Technical Support.

3365 Aborting static vport creation link state <link state> port state <port state>
Failure during static vPort creation.
ACTION: Report the error to Broadcom Technical Support.

3517 fail to rescan
Rescan through keyval page failed.
ACTION: Verify that all targets are still visible. If not, report the error to Broadcom Technical Support.

2567 Config region 23 has bad signature
Failure to read configuration region 23 - invalid signature.
ACTION: No action required.

2566 Failed to allocate connection table entry.
Failed to allocate connection table entry.
ACTION: No action required.

2891 Init VFI mailbox failed <mailbox status>
INIT_VFI mailbox failure.
ACTION: Report the error to Broadcom Technical Support.

2893 Failed to issue init_vfi mailbox
Failed to issue INIT_VFI mailbox command.
ACTION: Report the error to Broadcom Technical Support.

2892 Failed to allocate init_vfi mailbox
Failed to allocate INIT_VFI mailbox command.
ACTION: Report the error to Broadcom Technical Support.

0259 No NPIV Fabric support

Switch does not support NPIV.

ACTION: Check the switch configuration.

2731 Cannot find fabric controller node

Fabric controller ndlp is not present.

ACTION: Report the error to Broadcom Technical Support.

1815 Could not issue unreg_did (default rpis) status <return code>;

UNREG_DID command failure.

ACTION: Report the error to Broadcom Technical Support.

2749 Failed to prepare for unregistering HBA's FCF record: rc=<return code>

Unregister FCF failure.

ACTION: Report the error to Broadcom Technical Support.

2748 Failed to prepare for unregistering HBA's FCF record: rc=<return code>

Unregister FCF failure.

ACTION: Report the error to Broadcom Technical Support.

0228 CLEAR LA timeout

The driver issued a CLEAR_LA that never completed.

ACTION: None

2726 READ_FCF_RECORD Indicates empty FCF table

The driver requested the firmware provide a list of FCF entries to connect to, and the firmware responded that the FCF table is empty.

ACTION: Report the error to Broadcom Technical Support.

0222 Initial <FDISC/FLOGI> timeout

The driver sent the initial FLOGI or FDISC to the fabric and never received a response.

ACTION: Check fabric configuration. The driver recovers from this situation and continues with device discovery.

0223 Timeout while waiting for NameServer login

Login request to the NameServer was not acknowledged within R_A_TOV.

ACTION: Check the fabric configuration. The driver recovers from this and continues with device discovery.

0224 NameServer Query timeout Data: <retry count> <max retry count>

Node authentication timeout, node Discovery timeout. A NameServer query to the fabric or discovery of reported remote N_Ports is not acknowledged within R_A_TOV.

ACTION: Check the fabric configuration. The driver recovers from this and continues with device discovery.

0227 Node Authentication timeout

The driver has lost track of what N_Ports are being authenticated.

ACTION: No action required.

1800 Could not issue unreg_vpi

Driver attempt to unregister VPI failed.

ACTION: Software driver error. If this issue persists, report the error to Broadcom Technical Support.

0319 READ_SPARAM mbxStatus error <mailbox status> hba state <hba state>

The driver issued a READ_SPARAM mailbox command to the HBA that failed.

ACTION: This error could indicate a firmware or hardware issue. Report the error to Broadcom Technical Support.

3233 Error while allocating MSIX interrupts fallback to MSI

MSIX interrupt registration fails. Falling back to MSI.

ACTION: No action required.

0528 Mailbox CQ not allocated

The mailbox completion queue is not allocated.

ACTION: No action required.

1302 Invalid speed for this board> <cfg link speed>

The driver is reinitializing the link speed to autodetect.

ACTION: No action required.

0233 Nodelist not empty - Pending nodes are...

Driver unloaded or hot plug detected a node still in use.

ACTION: No action required.

2718 Clear Virtual Link Received for VPI <vpi> tag <event_tag>"

A clear virtual link was received from the fabric for this VPI.

ACTION: No action required.

3228 <function> stopped : state <do_work_state>

Worker thread stopped.

ACTION: No action required.

0454 INTX Interrupt Name Properties failed (<status string>)

INTX interrupt name properties set failed.

ACTION: Check the ESX host configuration and memory usage to free up some resources.

0421 MSI-X SP Interrupt register failed (<status string>)

MSI-X interrupt registration failed.

ACTION: Report the error to Broadcom Technical Support.

0465 MSI Interrupt Name Properties failed (<status string>)

Error in MSI interrupt registration path.

ACTION: Report the error to Broadcom Technical Support.

0478 MSIX Interrupt Enable for FCP failed (<status string>)

MSI-X interrupt registration failed.

ACTION: Report the error to Broadcom Technical Support.

0052 FATAL - unsupported SLI4 interface type - <sli interface type>

Unsupported interface type for SLI4 adapter.

ACTION: Report the error to Broadcom Technical Support.

0499 Failed allocate fast-path FCP CQ (<cqid>)

The completion queue event for the fast path could not be allocated.

ACTION: Check the ESX host configuration and memory usage to free up some resources.

3258 PathClaim thread death pending...

LPFC worker thread is going down.

ACTION: No action required.

3259 PathClaim Thread create in state <pathclaim_state>

LPFC thread create state.

ACTION: No action required.

0432 INTX Interrupt Register failed (<status string>)

INTX interrupt registration failed.

ACTION: Report the error to Broadcom Technical Support.

0541 Failed setup of Receive Queue: rc = <return code>

RQ_CREATE mailbox failure.

ACTION: Report the error to Broadcom Technical Support.

0540 Receive Queue not allocated

Failed to allocate RQ.

ACTION: No action required.

3276 Failed to create scsidone world.

Failed to create scsidone world.

ACTION: Report the error to Broadcom Technical Support.

3277 Failed to create scsidone world

Failed to create scsidone world.

ACTION: Report the error to Broadcom Technical Support.

1262 Failed to allocate dfc host.

Failed to allocate dfc host.

ACTION: Report the error to Broadcom Technical Support.

3143 Port Down: Firmware Update Detected

Firmware update detected.

ACTION: No action required.

3147 Fast-path EQs not allocated

Fast-path EQs not allocated.

ACTION: Check the system configuration and memory usage.

3148 Fast-path FCP CQ array not allocated

Fast-path FCP completion queue array is not allocated.

ACTION: Check the system configuration and memory usage.

3149 Fast-path FCP WQ array not allocated
Fast-path FCP WQ array not allocated.
ACTION: Check the system configuration and memory usage.

2562 Failure to allocate an ELS sgl entry:<index>
Failure to allocate an Extended Link Service SGL entry.
ACTION: Report the error to Broadcom Technical Support.

0505 Failed allocate slow-path MQ
Failed allocate slow-path multiqueue.
ACTION: Check the system configuration and memory usage.

7623 Checking UE recoverable
Checking for unrecoverable error recoverable.
ACTION: No action required.

0395 The mboxq allocation failed
Failed to allocate mailbox.
ACTION: Check the system configuration and memory usage.

3254 ERROR: invalid type <type>
Invalid type EPROM.
ACTION: Report the error to Broadcom Technical Support.

2598 Adapter Link is disabled
Adapter link 2598 is disabled.
ACTION: Report the error to Broadcom Technical Support.

2599 Adapter failed to issue DOWN_LINK mbox command rc <return>
Adapter failed to issue DOWN_LINK mailbox command.
ACTION: Report the error to Broadcom Technical Support.

4673 CGN Event empty object
Congestion management event empty object.
ACTION:

9032 Destroying vport <vport> refcnt <refcount>
Destroying virtual port (NPIV).
ACTION: No action required.

0397 The mbuf allocation failed
The memory buffer allocation failed.
ACTION: Check the system configuration and memory usage.

9036 Free vport with non-zero refcount <count>
Freeing vPort with nonzero refcount.
ACTION: No action required.

9035 Destroying Physical port <vport> refcnt <refcount>

Destroying physical port.

ACTION: No action required.

3296 LPFC_SLI_EVENT_TYPE_MISCONFIGURED event: Invalid link <port no>

Invalid link number for LPFC_SLI_EVENT_TYPE_MISCONFIGURED event.

ACTION: Report the error to Broadcom Technical Support.

4670 CGN RD OBJ returns no data

Congestion management read object returns no data.

ACTION: Report the error to Broadcom Technical Support.

3163 ELS xri-sgl count unchanged: <els_xri_cnt>

The Extended Link Service XRI SGL count is unchanged.

ACTION: No action required.

1421 Failed to set up hba

Failed to set up HBA.

ACTION: Report the error to Broadcom Technical Support.

4672 CgnParms write err (<ret>). Disable E2E mgmt

Congestion management write objecterror; disable E2E mgmt.

ACTION: Report the error to Broadcom Technical Support.

1422 Unrecoverable Error Detected during POST uerr_lo_reg=<uerrlo_reg> uerr_hi_reg=<uerrhi_reg>, ue_mask_lo_reg=<ue_mask_lo>, ue_mask_hi_reg=<ue_mask_hi>

Unrecoverable error detected during POST.

ACTION: Report the error to Broadcom Technical Support.

0321 Interrupt cfg mode set to <cfg_mode>

Interrupt cfg mode set to given mode in the cfg_mode.

ACTION: No action required.

2887 Reset Needed: Attempting Port Recovery...

Driver trying to reset by attempting port recovery.

ACTION: No action required.

0358 Interrupt cfg mode set to (<cfg_mode>) vectors (<vector_count>)

Interrupt cfg mode set with number of vectors.

ACTION: No action required.

0501 Failed allocate slow-path ELS CQ

Failed to allocate slow-path for an Extended Link Service completion queue.

ACTION: Check the operating system configuration; if issue is still seen, contact VMware or Broadcom Technical Support.

2563 Failure to allocate an ELS mbuf <index>

Failed to allocate an Extended Link Service memory buffer.

ACTION: Check the system configuration and memory usage.

2889 Port Overttemperature event, taking port offline Data: <err1> <err2>"

Temperature of the adapter is very high.

ACTION: Check the cooling mechanism of server. Ensure that the server fans are not blocked. Shut down the server if the airflow is restricted. Contact Broadcom Technical Support.

3360 LUN queue depth changed from <prev> to <new>

The LUN queue depth has changed.

ACTION: No action required.

3361 HBA queue depth changed from <prev> to <new>

The HBA queue depth has changed.

ACTION: No action required.

0507: Failed allocate receive DRQ

Failed to allocate receive DRQ.

ACTION: No action required.

0506 Failed allocate receive HRQ

The driver failed to allocate receive HRQ.

ACTION: No action required.

0468 MSI Interrupt Enable failed <fail code>

The driver failed to start the interrupt.

ACTION: Unload and reload the driver.

0463 MSI-X wanted <n> vectors, got <m>

The driver failed to get required MSI-X interrupt vectors.

ACTION: No action required.

0503: Failed allocate fast-path FCP WQ <wq_idx>

Failed to allocate fast-path FCP.

ACTION: No action required.

0467 MSI Interrupt Register failed <fail code>

The driver failed to register the interrupt.

ACTION: Unload and reload the driver.

0464 MSI alloc cookie failed <fail code>

The driver failed to allocate interrupt cookie.

ACTION: Unload and reload the driver.

0426 Failed to enable interrupt

The driver failed to enable the interrupt.

ACTION: Unload and reload the driver

2813 Mgmt I/O is Blocked <value> - mbox cmd <value> still active.

The HBA management interface is marked as blocked in preparation for an online or offline state transition. All user space access to the HBA through the libdfc interface will be blocked.

ACTION: No action required. Notification of a run-state change only.

0351: Config MSI mailbox command failed, mbxCmd <cmd>, mbxStatus <Status>

The mailbox command sent to the firmware to configure the adapter to use MSI-X has failed.

ACTION: Ensure that the hardware platform supports MSI-X.

4671 CgnParms read err (<return code>) Disable E2E mgmt

Unable to read congestion firmware parameters from the adapter.

ACTION: Report the error to Broadcom Technical Support.

0484 MSI-X Interrupt Enable failed <err_code>

The driver failed to start the interrupt.

ACTION: Unload and reload the driver.

0522 Fast-path EQ <eq_idx> not allocated

The fast-path event queue is not allocated.

ACTION: No action required.

3176: Misconfigured Physical Port - Port Name <value>

The driver has detected an unknown firmware name.

ACTION: Contact Broadcom Technical Support.

0474 Unable to allocate memory for issuing MBOX_CONFIG_MSI command

Mailbox memory pool allocation error.

ACTION: No action required.

2899 The mbuf allocation failed

The memory buffer allocation failed.

ACTION: No action required.

2898 The lpfc_dmabuf allocation failed);

The DMA buffer allocation failed.

ACTION: No action required.

0473 MSI Interrupt Enable failed <fail code>

The driver failed to start the interrupt.

ACTION: Unload and reload the driver.

0472 MSI Interrupt Register failed <fail code>

The driver failed to register the interrupt.

ACTION: Unload and reload the driver.

2895 Non FC link Event detected <value>

Non FC link event detected.

ACTION: No action required.

2894 SLI_INTF reg contents invalid sli_intf reg <value>
SLI_INTF reg contents invalid sli_intf reg <value>
ACTION: No action required.

2897 The mboxq allocation failed
The driver could not allocate mbox queue.
ACTION: No action required.

0479 Deferred Adapter Hardware Error Data: <host_status> <status1> <status2>
An adapter hardware error was sent to the driver.
ACTION: Perform a dump using hbacmd.

2890 Port not ready, port status reg <value> error 1=<val> error 2=<val>
Port error detected during port reset.
ACTION: Reboot the server. Contact Broadcom Technical Support.

2576 Failed allocate memory for fast-path EQ record array
Failed to allocate memory for the fast-path event queue record array.
ACTION: No action required.

3144 Port Down: Debug Dump
Port Down: Debug Dump
ACTION: Reboot the server. Contact Broadcom Technical Support.

2012: Mailbox failed , mbxCmd <mbx_cmd> READ_CONFIG, mbxStatus <mbx status>
The READ_CONFIG mailbox command failed.
ACTION: No action required.

0408 Failed to create path claim world.
The driver failed to create new thread.
ACTION: Unload and reload the driver.

2560 Failed to allocate xri for scsi buffer
Initialization could not allocate memory to hold the XRIs.
ACTION: No action required.

3145 Port Down: Provisioning
The driver failed to create new thread.
ACTION: Unload and reload the driver.

0396 The lpfc_dmabuf allocation failed);
The asynchronous link event handler could not allocate a mailbox command to issue the READ_LA mailbox command.
ACTION: Unload and reload the driver.

0498 Adapter failed to init, mbxCmd <mbx_cmd> INIT_LINK, mbxStatus <mbx_status>
The adapter failed to initialize. The INIT_LINK command failed.
ACTION: Ensure that the adapter firmware is current. Unload and reload the driver.

0391 Error during rpi post operation

The driver while trying to post pages to the firmware to keep target login information encountered a failure.

ACTION: Unload and reload the driver.

0493: SLI_CONFIG_SPECIAL mailbox failed with status<rc>

Mailbox command failed.

ACTION: Ensure that the adapter firmware is current. Unload and reload the driver.

0492 Unable to allocate memory for issuing SLI_CONFIG_SPECIAL mailbox command

Mailbox memory pool allocation error.

ACTION: No action required.

0491 Adapter Link is disabled.

Adapter link is disabled by administrator

ACTION: Check the cables, and enable the link using application.

0398 Unknown link fault code: <code>

The attempt to read the link attention register returned an unknown value.

ACTION: Check the cables, and reload the driver.

0399 Invalid link attention type: <evt_type>

The READ_LA mailbox command returned an invalid link type.

ACTION: Check the cables and reload the driver. Reset the HBA.

0495: SLI_FUNCTION_RESET mailbox failed with status <shdr_status> add_status <shdr_add_status>, mbx status <rc>.

Mailbox command failed.

ACTION: Reset the HBA.

0494 Unable to allocate memory for issuing SLI_FUNCTION_RESET mailbox command

Mailbox memory pool allocation error.

ACTION: No action required.

2578 Failed allocate memory for fast-path WQ record array

Failed to allocate memory for the fast-path event queue record array.

ACTION: No action required.

9182 DMA Buffer size check failed: Used <idx> Allocated <size>

The DMA buffer size is not as per expected value.

ACTION: Reload the driver. Reset the HBA.

0504 Failed allocate slow-path ELS WQ

Failed to allocate memory for the slow-path Extended Link Service event queue record array.

ACTION: Reload the driver.

0796 LUN Reset on Target <FCID> <LUN> <State> <status>

A LUN reset was issued by SCSI stack to the specified target.

ACTION: No action required.

0525: Failed to setup FOF EQ lock <error code>

The driver failed to set up the FOF event queue lock.

ACTION: Unload and reload the driver.

0401 Link fault code: <value>

The link went into fault mode.

ACTION: Check the cables, and reload the driver.

3231 Error while allocating MSI interrupt fallback to INTx

The driver failed to allocate MSI interrupts, so falling back to INTx.

ACTION: No action required.

0406: Adapter maximum temperature exceeded <temperature>, taking this port offline

The driver has received an error for the HBA indicating that the maximum allowable temperature has been exceeded.

ACTION: Ensure that the server fans are not blocked. Shut down the server if the airflow is restricted.

0407 Target Reset on Target <FCID> <LUN> <State> <status>

A target reset was issued by SCSI stack to the specified target.

ACTION: No action required.

4000 Failed to query PCI IO resources <status> - Disable DPP.

The driver fails to query PCI IO resources.

ACTION: Disable DPP feature, and reload the driver.

4001 Failed to reserve DPP resource <status> - Disable DPP

The driver fails to reserve DPP resources.

ACTION: Disable DPP feature, and reload the driver.

4002 Failed to map DPP registers <status> - Disable DPP

The driver fails to map DPP registers.

ACTION: Disable the DPP feature, and reload the driver.

3344 HBA queue depth changed from <prev> to <new>

The HBA queue depth has changed.

ACTION: No action required.

2747 Issue FCF scan read FCF mailbox command failed <error code>

The firmware failed the FCF mailbox command.

ACTION: Unload and reload the driver.

0461 INTX Interrupt Enable failed <fail code>

The driver failed to enable the interrupt.

ACTION: Unload and reload the driver.

0714 SCSI layer issued Bus Reset Data <status>

The SCSI layer is requesting the driver to abort all I/Os to all targets on this HBA.

ACTION: Check the state of the targets in question.

0524: Failed to setup EQ lock <error code>

The driver failed to setup the event queue lock.

ACTION: Unload and reload the driver.

0022 FATAL - unsupported SLI4 interface type - <if_value>

The adapter is not supported by the driver.

ACTION: Update to latest firmware or replace the adapter.

2877: FCP XRI exchange busy wait time: <value> seconds

An FCP exchange cannot be released – no port completion. The driver is waiting.

ACTION: This is a software driver error. If this issue persists, report the error to Broadcom Technical Support.

3234 Error while allocating MSIX interrupts fallback to MSI

The driver failed to allocate MSI-X interrupts, so falling back to MSI.

ACTION: No action required.

0431 Failed to enable interrupt.

The driver failed to start the interrupt.

ACTION: Unload and reload the driver.

2644 Failed to alloc memory for RX Monitor Buffer

Failure to allocate memory for RX monitor table.

ACTION: No action required.

2645 Failed to alloc memory for RX Monitor Buffer

Failure to allocate memory for RX monitor table.

ACTION: No action required.

0485 MSI alloc cookie failed <fail code>

The driver failed to allocate interrupt cookie.

ACTION: Unload and reload the driver.

1430 Failed to initialize sgl list.

Failed to initialize SQL list.

ACTION: No action required.

0403 Failed to create path claim world.

The driver failed to create new thread.

ACTION: Unload and reload the driver.

0486 MSI-X Interrupt Register failed <fail code>

The driver failed to register the interrupt.

ACTION: Report the error to Broadcom Technical Support.

0427: Cannot re-enable interrupt after slot reset
The driver was not able to enable the interrupt after an adapter reset.
ACTION: Unload and reload the driver.

0434 MIS-X Interrupt Name Properties failed <vmkStat>
MSIx initialization failed.
ACTION: Unload and reload the driver. If the issue persists, report the error to Broadcom Technical Support.

0487 PCI enable MSI-X failed <vmkStat>
Enabling MSix failed.
ACTION: Unload and reload the driver. If the issue persists, report the error to Broadcom Technical Support.

3359 HBA queue depth changed from <value> to <value>
Updated HBA queue depth value.
ACTION: No action required.

0526: Fast-path FCP CQ <fcp_cqid> not allocated
The fast-path FCP is not allocated.
ACTION: The driver fails to load. Contact Broadcom Technical Support.

0411 Failed to alloc memory for Congestion Info
Failed to allocate congestion data buffer.
ACTION: The driver fails to load. Contact Broadcom Technical Support.

1804: Invalid asynchronous event code: <evt code>
The asynchronous event code that the firmware passed to the driver is invalid.
ACTION: No action required.

4669 FW cgn parm buf wrong magic <magic_num> version <version>
Invalid congestion buffer signature from firmware.
ACTION: No action required. If the issue persists, report the error to Broadcom Technical Support.

3119 Failed to get SystemVer <vmkStat>
Failed to get the operating system version information.
ACTION: No action required.

3118 Failed to close CfgParm Handle <vmkStat>
Failed to close config param handle.
ACTION: No action required.

3117 Failed to open CfgParm Handle. <vmkStat>
Failed to open config param handle.
ACTION: No action required

1201: Failed to allocate dfc_host
The driver failed to allocate a DFC host and bind it to the management stack.
ACTION: This is a software driver error. If this issue persists, report the error to Broadcom Technical Support.

4667 Error reading Cgn Params

Unable to read congestion firmware parameters from adapter.

ACTION: No action required. If the issue persists, report the error to Broadcom Technical Support.

1431: Invalid HBA PCI-device group: <dev_grp>

An invalid adapter PCI-device group was detected.

ACTION: No action required.

8912 Async FC Trunking Event - Speed Logical speed: port0 <Link_status> port1 <link_status> port2 <link_status> port3 <link_status>

Trunked port link status update.

ACTION: No action required.

8913 trunk error:<trunk_error> seen on port0: <Link_Status> port1:<Link_Status> port2:<Link_Status> port3:<Link_Status> UNDEFINED. update driver

Trunk port setting error.

ACTION: If the issue persists, report the error to Broadcom Technical Support.

0150 Attempting reset to recover from UE

Driver in recovery phase from UE.

ACTION: No action required.

3190 Over Temperature: <Value> Celsius- Port Name <Value>

Display temperature above the threshold value.

ACTION: No action required. If the issue persists, report the error to Broadcom Technical Support.

0314 Failed to start lpfc_do_work World

Failed to create the world.

ACTION: The driver fails to load. Contact Broadcom Technical Support.

0529: Failed setup of slow-path mailbox CQ: rc = <value>

The driver failed to set up the completion queue. A failure code is reported.

ACTION: This is a software driver error. If this issue persists, report the error to Broadcom Technical Support.

0475 Not configured for supporting MSI-X cfg_use_msi: <cfg_use_msi>.

The lpfc_use_msi module parameter should have been set to 2.

ACTION: Set module parameter lpfc_use_msi=2.

1814 Mbox <u.mb.mbxCommand> failed, no vport

The vPort field of this mailbox command was not completed.

ACTION: This is a software driver error. If this issue persists, report the error to Broadcom Technical Support.

2527: Failed to allocate non-embedded SGE array.

The driver failed to allocate the nonembedded scatter/gather entry array.

ACTION: No action required.

2929: Resource Extent Opcode <value> is unsupported

Unsupported event code.

ACTION: No action required.

2605: lpfc_dump_static_vport: memory allocation failed

Memory allocation failed.

ACTION: Try closing other applications to free some memory. If this issue persists, report the error to Broadcom Technical Support.

3569 dump type 3 page 0xA0 allocation failed

Memory allocation failure.

ACTION: Try closing other applications to free some memory. If this issue persists, report the error to Broadcom Technical Support.

0301 READ_SPARAM: no buffers

The driver attempted to issue a READ_SPARAM mailbox command to the adapter, but there were no buffers available.

ACTION: Try closing other applications to free some memory. If this issue persists, report the error to Broadcom Technical Support.

3371 Alloc failure from Slab <Slab_ID> Caller <func:line> cur cnt <Curr_Slab_Cnt> Max <Max_Slab_Cnt>
Slab allocation failure.

ACTION: Try closing other applications to free some memory. If this issue persists, report the error to Broadcom Technical Support.

3309 Alloc failure. Caller <func> <line>

Heap allocation failure.

ACTION: Try closing other applications to free some memory. If this issue persists, report the error to Broadcom Technical Support.

3480 Failed to Create Slab Status <vmkStat> <func> <line>

Slab creation failed. The driver fails to load.

ACTION: Contact Broadcom Technical Support.

3310 Alloc failure. Caller <func> <line>

Aligned heap allocation failure.

ACTION: Try closing other applications to free some memory. If this issue persists, report the error to Broadcom Technical Support.

3207 <func_name> DMAMapSg failed addr <virt_addr> size <size> rc <ret_val> string <err_msg>

DMA mapping of SG array to I/O address failed.

ACTION: This is a software error. If this issue persists, report the error to Broadcom Technical Support.

3206 <func_name> DMAMapSg failed addr <virt_addr> size <size> rc <ret_val> string <err_msg>

DMA mapping of SG array to I/O address for SCSI buffer failed.

ACTION: This is a software error. If this issue persists, report the error to Broadcom Technical Support.

3204 <func_name> DMAMapSg failed addr <virt_addr> size <size> rc <ret_val> string <err_msg>

DMA mapping of SG array to I/O address for Extended Link Service buffer failed.

ACTION: This is a software error. If this issue persists, report the error to Broadcom Technical Support.

3202 <func_name> DMAMapSg failed addr <virt_addr> size <size> rc <ret_val> string <err_msg>

DMA mapping of SG array to I/O address for memory buffer failed.

ACTION: This is a software error. If this issue persists, report the error to Broadcom Technical Support.

3201 No extended DMAMapSg err data

DMA map SG error.

ACTION: This is a software error. If this issue persists, report the error to Broadcom Technical Support.

3200 No IO Space Err. MaxMappable <error_info>

Not enough I/O address space available to map elements.

ACTION: This is a software error. If this issue persists, report the error to Broadcom Technical Support.

3374 Slab Obj for ID <slab_id> Alloc <func:line> Free <func:line>

Slab memory to be freed not found.

ACTION: No action required.

3209 <func_name> DMAMapSg failed addr <virt_addr> size <size> rc <ret_val> string <err_msg>

DMA mapping of SG array to I/O address for data receive buffer failed.

ACTION: No action required.

3208 <func_name> DMAMapSg failed addr <virt_addr> size <size> rc <ret_val> string <err_msg>

DMA mapping of SG array to I/O address for header receive buffer failed.

ACTION: No action required.

3197 AddrStraddle Err. Bdry <error_info> ElemNum <bad_element>

Could not map SG array to fit within the sgMaxEntries constraint with the sgElemStraddle constraint.

ACTION: This is a software error. If this issue persists, report the error to Broadcom Technical Support.

3196 ElemSizeMulti Err. Size <error_info> ElemNum <bad_element>

Could not map SG array to fit within the sgMaxEntries constraint with the sgElemMult constraint.

ACTION: This is a software error. If this issue persists, report the error to Broadcom Technical Support.

3195 Max Size Err-> Max %d ElemNum %d, err->info.elemMaxSize.sgElemMaxSize, err->info.elemMaxSize.badElem

Could not map SG array to fit within sgMaxEntries constraint with the sgElemMaxSize constraint.

ACTION: This is a software error. If this issue persists, report the error to Broadcom Technical Support.

3194 Too Many Entries count <sg_entry_count>

There were too many SG array elements in the SG array, and the mapping code was unable to coalesce the array to fit.

ACTION: This is a software error. If this issue persists, report the error to Broadcom Technical Support.

3199 Address Alignment Err. Align <alignment> ElemNum <element>

One or more SG array elements are not aligned properly.

ACTION: This is a software error. If this issue persists, report the error to Broadcom Technical Support.

3198 Address Err. Mask <addr_mask> ElemNum <element>

One or more SG array elements do not meet the address mask of the DMA engine.

ACTION: This is a software error. If this issue persists, report the error to Broadcom Technical Support.

3271 OAS slab empty

OAS slab allocation failed.

ACTION: If this issue persists, report the error to Broadcom Technical Support.

2946: SLI_CONFIG(hbd) rd, ext_buf_cnt(<value>) out of range(<max_value>)

Host buffer descriptor count out of range.

ACTION: If this issue persists, report the error to Broadcom Technical Support.

2945: SLI_CONFIG(mse) rd, ext_buf_cnt(<value>) out of range(<value>)
SLI_CONFIG read mailbox failed.
ACTION: No action required.

3383 OAS detected unsupported string version <version>
Unsupported OAS version.
ACTION: This is a software error. If this issue persists, report the error to Broadcom Technical Support.

3381 No OAS version pointer from caller
No OAS version passed.
ACTION: This is a software error. If this issue persists, report the error to Broadcom Technical Support.

1944: ENOMEM kernel memory resource unavailable
The driver failed to allocate a kernel buffer for a timed-out I/O request.
ACTION: This is a software driver error. If this issue persists, report the error to Broadcom Technical Support.

3389 OAS parser error - <rules> rules found with a partial rule length of <len>
Error is parsing OAS rule.
ACTION: This is a software error. If this issue persists, report the error to Broadcom Technical Support.

3070: lpc_clr_ndlps_pri: fcp_priority sz = <value>
Clear FCP priority for the target.
ACTION: No action required.

3150: No privilege to perform the requested access: <requested_action>
The driver lacks the necessary privileges for the requested action.
ACTION: Contact Broadcom Technical Support.

2954: SLI_CONFIG(hbd) wr to interface type:<value>
Write to interface type.
ACTION: This is a software error. If this issue persists, report the error to Broadcom Technical Support.

3382 OAS parser error - <rules> rules found with a partial rule length of <len>
Error is parsing OAS rule.
ACTION: This is a software error. If this issue persists, report the error to Broadcom Technical Support.

2950: Failed SLI_CONFIG(hbd) rd (<value>)
Mailbox issue failed.
ACTION: This is a software error. If this issue persists, report the error to Broadcom Technical Support.

3050 SLI_CONFIG(hbd) wr,ext_buf_cnt <value> out of range <value>
Host buffer descriptor count out of range.
ACTION: If this issue persists, report the error to Broadcom Technical Support.

3153: Fail to perform the requested access: <value>
The driver failed to execute the requested management action.
ACTION: Contact Broadcom Technical Support.

3377 OAS slab empty

OAS slab memory allocation failure.

ACTION: This is a software driver error. If this issue persists, report the error to Broadcom Technical Support.

3444 Failed SLI_CONFIG(hbd) wr <value>

Write to interface type.

ACTION: This is a software error. If this issue persists, report the error to Broadcom Technical Support.

3032 SLI_CONFIG(hbd) rd to interface type: <value>

Read to interface type.

ACTION: This is a software error. If this issue persists, report the error to Broadcom Technical Support.

1209: C_CT Request error Data: <resp_buff_flag> <data_size>

IOCTL common transport response error -- the driver is failing the IOCTL request.

ACTION: This is a software driver error. If this issue persists, report the error to Broadcom Technical Support.

1208: C_CT Request error Data: <resp_buff_flag> <data_size>

IOCTL common transport response error -- the driver is failing the IOCTL request.

ACTION: This is a software driver error. If this issue persists, report the error to Broadcom Technical Support.

1952: ENOMEM DMA resource not available

The driver failed to get the DMA buffers needed for a loopback test.

ACTION: This is a software driver error. If this issue persists, report the error to Broadcom Technical Support.

1928: Exec format error

There was no dfchba instance available.

ACTION: This is a software driver error. If this issue persists, report the error to Broadcom Technical Support.

3142: Failed loopback test issue iocb: iocb_stat: <ret_val>

Loopback test failed.

ACTION: This is a software driver error. If this issue persists, report the error to Broadcom Technical Support.

3412: Restart FW Logging

RAS buffer memory not allocated.

ACTION: Restart RAS firmware-logging support.

1927 VMK_NO_MEMORY kernel memory resource unavailable

The driver failed to allocate a kernel memory.

ACTION: This is a software driver error. If this issue persists, report the error to Broadcom Technical Support.

1929 Exec format error

There was no dfchba instance available for an IOCTL loopback XRI read – dropping.

ACTION: This is a software driver error. If this issue persists, report the error to Broadcom Technical Support.

3069: Clearing FCP rules

Clear the FCP priority rules.

ACTION: This is a software driver error. If this issue persists, report the error to Broadcom Technical Support.

3172 Attempted to add already registered entry <uuid> with vmid: <cs_ctl>

Attempted to re-register a VMID entry.

ACTION: This is a software driver error. If this issue persists, report the error to Broadcom Technical Support.

3125: Not receiving unsolicited event <ret_val>

Mgmt Loopback Test. IOCB timed out.

ACTION: This is a software driver error. If this issue persists, report the error to Broadcom Technical Support.

3071: no memory for priority rules

Memory allocation for FCP priority rules setting failed.

ACTION: This is a software driver error. If this issue persists, report the error to Broadcom Technical Support.

1957 VMK_NO_PERMISSION Illegal BDE count <rcv_buf_cnt>

The driver received too many receive buffers for a loopback operation.

ACTION: This is a software driver error. If this issue persists, report the error to Broadcom Technical Support.

1949 VMK_NOT_EXEC NULL param passed to function

The driver tried to post a receive buffer, but no receive buffers are available.

ACTION: This is a software driver error. If this issue persists, report the error to Broadcom Technical Support.

1951 VMK_NO_MEMORY MBUF resources

The driver failed to get the memory buffer needed for a loopback test.

ACTION: This is a software driver error. If this issue persists, report the error to Broadcom Technical Support.

1950 VMK_NO_MEMORY IOCB resource not available

The driver could not allocate the IOCBs needed to post loopback receive buffers.

ACTION: This is a software driver error. If this issue persists, report the error to Broadcom Technical Support.

1935 Loopback did not receive data

The driver ran a loopback test but did not receive a response.

ACTION: This is a software driver error. If this issue persists, report the error to Broadcom Technical Support.

1934 VMK_NO_MEMORY DMA coherent resource unavailable

The driver failed to allocate a DMA buffer for an IOCTL request.

ACTION: This is a software driver error. If this issue persists, report the error to Broadcom Technical Support.

3171 Attempted to delete unregistered entry <uuid> with vmid: <vmid>

Unregistered VMID entry tried to be deleted.

ACTION: This is a software driver error. If this issue persists, report the error to Broadcom Technical Support.

3141 Loopback mode:<link_flags> not supported

Loopback mode passed by user, not supported.

ACTION: Check the loopback mode passed. If this issue persists, report the error to Broadcom Technical Support.

3010: Run link diag test mailbox failed with mbx_status <value> status <value>, add_status <value>

Link diagnostics test failed.

ACTION: This is a software driver error. If this issue persists, report the error to Broadcom Technical Support.

3170 Update process failed for entry[<entry>] with status: <status>

VMID update process failed for entry.

ACTION: This is a software driver error. If this issue persists, report the error to Broadcom Technical Support.

1936 VMK_NO_MEMORY Kernel resource unavailale);

The driver failed to allocate a DMA buffer during a loopback test.

ACTION: This is a software driver error. If this issue persists, report the error to Broadcom Technical Support.

0362 Unsupported MQ count. (<entry count>)

Unsupported MQ entry count.

ACTION: No action required.

3023 Allocated DMA memory size (<alloclen>) is less than requested (<reqlen>)

Allocated mailbox command memory size is less than the requested size.

ACTION: Report the error to Broadcom Technical Support.

(<vpi>):0311 Mailbox command <mailbox command code> cannot issue Data: <sli flag> <flag>

Cannot issue mailbox command because link is in error state.

ACTION: Report the error to Broadcom Technical Support.

3321 Recovered mailbox <mailbox command code>

Mailbox command recovered.

ACTION: No action required.

2365 Failed to get SG alloc address status <status string>

Memory allocation failure during MDS diagnostics.

ACTION: Report the error to Broadcom Technical Support.

0366 Not a valid fast-path completion event: majorcode=<event type>, minorcode=<additional info>

Not a completion queue event.

ACTION: No action required.

2620 Config region 23 has bad version

Failure to read Config Region 23 - invalid version.

ACTION: No action required.

1832 No pending MBOX command to handle

No outstanding mailbox command to process.

ACTION: No action required.

2746 Requesting for FCF rediscovery failed status <status> add_status <additional status>

Rediscover FCF mailbox command failed.

ACTION: Report the error to Broadcom Technical Support.

2523 Allocated DMA memory size (<alloclen>) is less than the requested DMA memory size (<reqlen>)

Allocated mailbox command memory size is less than the requested size.

ACTION: Report the error to Broadcom Technical Support.

3252 WQ[<workqueue id>] doorbell offset not supported: <offset>

Unsupported WQ doorbell offset.

ACTION: Report the error to Broadcom Technical Support.

(<vpi>):2529 Mailbox command <mailbox command code> cannot issue Data: <sli flag> <flag>

Cannot issue mailbox because another mailbox command is already active.

ACTION: Report these errors to Broadcom Technical Support.

(<vpi>):2528 Mailbox command <mailbox command code> cannot issue Data: <sli flag> <flag>"

Cannot issue mailbox because mailbox interrupt is disabled.

ACTION: Report the error to Broadcom Technical Support.

2009 Failed to allocate mbox for ADD_FCF cmd

Cannot allocate memory mailbox command.

ACTION: Report the error to Broadcom Technical Support.

2536 Unsupported RQ count. (<entry_count>)

Unsupported RQ entry count.

ACTION: No action required.

0144 Not a valid WCQE code: <wcqe code>

Invalid WCQE code.

ACTION: Report the error to Broadcom Technical Support.

2014 Invalid command <iocb command code>

Invalid IOCB.

ACTION: Report these errors to Broadcom Technical Support.

(<vpi>):0304 Stray Mailbox Interrupt mbxCommand <mailbox command code> mbxStatus <mailbox status>

Stray mailbox interrupt.

ACTION: Report the error to Broadcom Technical Support.

0303 Ring <ring number> handler: portRspPut <put index> is bigger than rsp ring <max index>

Ring put index is greater than size.

ACTION: Report these errors to Broadcom Technical Support.

2010 Resume RPI Mailbox failed status <return code>, mbxStatus <mailbox status>

RESUME_RPI mailbox command failure.

ACTION: Report the error to Broadcom Technical Support.

2509 RQ_DESTROY mailbox failed with status <mailbox status> add_status <additional status>, mbx status <return code>

RQ_DESTROY mailbox command failure.

ACTION: Report the error to Broadcom Technical Support.

2919 Failed to release resource extents for type <extent type> - Status <mailbox status> Add'l Status <additional status>. Resource memory not released.

Deallocation resource extent mailbox command failure.

ACTION: Report the error to Broadcom Technical Support.

2707 Ring <els ring number> handler: Failed to allocate iocb Rctl <fc header rctl> Type <fc header type> received

IOCB is not available to process unsolicited requests.

ACTION: Report these errors to Broadcom Technical Support.

2508 WQ_DESTROY mailbox failed with status <mailbox status> add_status <additional status>, mbx status <return code>

WQ_DESTROY mailbox command failure.

ACTION: Report the error to Broadcom Technical Support.

2856 Config Port Security Crypto Error: <error code>

Configuration port security crypto error.

ACTION: Report the error to Broadcom Technical Support.

8029 PCIe Read from <address> failed after <retry count> attempts.

PCIe read failure.

ACTION: Report these errors to Broadcom Technical Support.

2619 Config region 23 has bad signature

Failure to read Config Region 23 – invalid signature.

ACTION: Report these errors to Broadcom Technical Support.

0438 Adapter failed to init, chipset, status reg <status register value>, FW Data: A8 <UERR_MASK_LO> AC <UERR_MASK_HI>

Adapter initialization failed.

ACTION: Report the error to Broadcom Technical Support.

2558 ADD_FCF_RECORD mailbox failed with status <mailbox status> add_status <additional status>

ADD_FCF_RECORD mailbox failed.

ACTION: Report the error to Broadcom Technical Support.

3037 Allocated DMA memory size (<alloclen>) is less than requested (<reqlen>)

Allocated mailbox command memory size is less than requested size.

ACTION: Report the error to Broadcom Technical Support.

3030 Delete Object mailbox failed with status <mailbox status> add_status <additional status>, mbx status <return code>

DELETE_OBJECT mailbox command failed.

ACTION: Report the error to Broadcom Technical Support.

1820 Unable to select SLI-3. Not supported by adapter

Adapter initialization failed.

ACTION: Report the error to Broadcom Technical Support.

0437 Adapter failed to init, chipset, status reg <status register value>, FW Data: A8 <UERR_MASK_LO> AC <UERR_MASK_HI>

Adapter initialization failed.

ACTION: Report the error to Broadcom Technical Support.

0436 Adapter failed to init, timeout, status reg <status register value>, FW Data: A8 <UERR_MASK_LO> AC <UERR_MASK_HI>

Adapter initialization failed.

ACTION: Report the error to Broadcom Technical Support.

0602 Failed to allocate CQ_EVENT entry

The completion queue event pool is empty.

ACTION: Report the error to Broadcom Technical Support.

1419 Invalid HBA PCI-device group: <pci device group id>

Invalid PCI device group.

ACTION: Report the error to Broadcom Technical Support.

0338 IOCB wait timeout error - no wake response Data <timeout value>

IOCB timed out waiting for a response.

ACTION: Report the error to Broadcom Technical Support.

2000 Failed to allocate mbox for READ_FCF cmd

Memory allocation failure.

ACTION: Report the error to Broadcom Technical Support.

0334 Unknown IOCB command Data: <type> <command> <status> <iotag> <ulpcontext>

Unknown IOCB command.

ACTION: Report the error to Broadcom Technical Support.

0335 Unknown IOCB command Data: <command> <status> <iotag> <context>

Unknown IOCB command.

ACTION: Report the error to Broadcom Technical Support.

9148 OAS completion queue does not exist

OAS completion queue does not exist.

ACTION: Report the error to Broadcom Technical Support.

9149 Miss-matched fast-path compl queue id: eqcqid=%d, fcpcqid=%d

Completion queue ID mismatch in FOF the event queue entry handler.

ACTION: Report the error to Broadcom Technical Support.

3164 Abort failed: No iocbqs: Data: <xri> <iotag> <ulpcontext> <command>

IOCB is not available to send abort.

ACTION: Report the error to Broadcom Technical Support.

3300 Ring <ring number> issue: portCmdGet <get index> is bigger than cmd ring <end of ring>

Ring get index is greater than size.

ACTION: Report the error to Broadcom Technical Support.

0326 Not a valid fast-path completion event: majorcode=<event type>, minorcode=<additional info>

Not a completion queue event.

ACTION: Report the error to Broadcom Technical Support.

3471 RAS FW-Logging Enable Failed :<status string>
RAS FW logging is not enabled.
ACTION: No action required.

0323 Unknown Mailbox command <command> (<subsystem>/<opcode>) Cmpl
Unknown mailbox command.
ACTION: Report the error to Broadcom Technical Support.

2983 Allocated DMA memory size (<allocLen>) is less than the requested DMA memory size (<reqLen>)
Allocated mailbox command memory size is less than requested size.
ACTION: Report the error to Broadcom Technical Support.

2982 Allocated DMA memory size (<allocLen>) is less than the requested DMA memory size (<reqLen>)
Allocated mailbox command memory size is less than the requested size.
ACTION: Report the error to Broadcom Technical Support.

0285 Allocated DMA memory size (<allocLen>) is less than the requested DMA memory size (<reqLen>)
Allocated mailbox command memory size is less than requested size.
ACTION: Report the error to Broadcom Technical Support.

3479 Invalid provisioning of rpi:<max_rpi>
Maximum RPI count is zero or negative.
ACTION: Report the error to Broadcom Technical Support.

3573 RAS Mailbox failed. status <rc> mbxStatus : x<lpfc_mqe_status>
The mailbox to initialize firmware logging in host has failed.
ACTION: No action required.

2984 Failed to read allocated resources for type <response> - Status 0x<status>
The mailbox to get allocated extent resource has failed.
ACTION: No action required.

3025 Write Object mailbox failed with status x<shdr_status> add_status x<shdr_add_status>, mbx status x<rc>
The write object mailbox command has failed.
ACTION: No action required.

0445 Firmware initialization failed
The SLI3 HBA initialization has failed.
ACTION: Check if port reset brings back to normal state. If issue persists, contact Broadcom Technical Support.

0446 Adapter failed to init <rc>, mbxCmd x<mbxCommand> CFG_RING, mbxStatus x<mbxStatus>, ring <i>
The configuration ring mailbox has failed.
ACTION: Check if port reset brings back to normal state. If issue persists, contact Broadcom Technical Support.

1400 Failed to update xri-sgl size and mapping: <rc>
Failed to initialize SGL list during initialization.
ACTION: No action required.

0442 Adapter failed to init, mbxCmd x<mbxCommand> CONFIG_PORT, mbxStatus x<mbxStatus>

Adapter initialization failed when issuing a CONFIG_PORT mailbox command.

ACTION: This error could indicate a hardware or firmware issue. If this issue persists, report the error to Broadcom Technical Support.

0443 Adapter did not grant BlockGuard

Adapter does not support the BlockGuard feature.

ACTION: No action required.

2600 failed to allocate mailbox memory

Failed to allocate memory for configure region 23 mailbox command.

ACTION: No action required.

2763 Failed to allocate mbox for READ_FCF cmd

Memory for the READ_FCF command is not allocated.

ACTION: Report the error to Broadcom Technical Support.

2762 FCF <fcf_index> reached driver's book keeping dimension: <LPFC_SLI4_FCF_TBL_INDX_MAX>

The FCF index is beyond the driver allocated FCF table.

ACTION: Report the error to Broadcom Technical Support.

2537 Receive Frame Truncated

Asynchronous frame received, but exceeded buffer length. Frame payload truncated.

ACTION: Report the error to Broadcom Technical Support.

3669 DMA buffer allocation failed for FW logging

DMA memory for storing the RAS firmware log is unavailable.

ACTION: Report the error to Broadcom Technical Support.

1423 HBA Unrecoverable error: uerr_lo_reg=<uerr_sta_lo>, uerr_hi_reg=<uerr_sta_hi>, ue_mask_lo_reg=<ue_mask_lo>, ue_mask_hi_reg=<ue_mask_hi>

An unrecoverable HBA error is reported.

ACTION: Report the error to Broadcom Technical Support.

2930 Failed to get resource extents Status <lpfc_mbox_hdr_status> Add'l Status <lpfc_mbox_hdr_add_status>

The mailbox command to get the resource extent from firmware has failed.

ACTION: Report the error to Broadcom Technical Support.

2514 POST_RPI_HDR mailbox failed with status <shdr_status> add_status <shdr_add_status>, mbx status <rc>

The POST_RPI_HDR mailbox is failed by the firmware.

ACTION: Report the error to Broadcom Technical Support.

0394 Failed to allocate CQ_EVENT entry

There is not enough driver resource to handle the completion queue event.

ACTION: Report the error to Broadcom Technical Support.

3262 RQ <queue_id> doorbell format not supported: <db_format>

The doorbell format is not supported for this receive queue.

ACTION: Report the error to Broadcom Technical Support.

4111 UNREG cmpl deferred clr <nlp_rpi> on NPort <nlp_DID> Data: <nlp_defer_did> <ndlp>

There is some deferred event to be processed after UNREG_LOGIN mailbox completion.

ACTION: No action required.

2886 HBA Error Attention on unsupported if type <if_type>

HBA error attention event is reported for the unsupported interface type.

ACTION: Report the error to Broadcom Technical Support.

0388 Not a valid WCQE code: <lpfc_cqe_code>

Received an invalid work queue completion queue entry from the firmware.

ACTION: Report the error to Broadcom Technical Support.

0299 Invalid SLI revision <sli_rev>

Driver identified an invalid SLI revision while executing.

ACTION: Report the error to Broadcom Technical Support.

3465 WQ<queue_id> doorbell format not supported: <db_format>

The doorbell format is not supported for this work queue.

ACTION: Report the error to Broadcom Technical Support.

0359 No entry from fast-path completion queue fcpcqid=<queue_id>

There is no entry in the completion queue.

ACTION: No action required.

2885 Port Status Event: port status reg <portstat_reg.word0>, port smphr reg <portsmphr>, error 1=<work_status[0]>, error 2=<work_status[1]>

Firmware has reported port status event.

ACTION: Report the error to Broadcom Technical Support.

0350 rc should have been MBX_BUSY

The driver is unable to post the UNREG_LOGIN mailbox to the firmware.

ACTION: Report the error to Broadcom Technical Support.

1438 UNREG cmpl deferred mbox <nlp_rpi> on NPort <nlp_DID> Data: <nlp_flag> <nlp_defer_did> <ndlp>

Check for any deferred event after UNREG_LOGIN mailbox completion.

ACTION: No action required.

0593 Error <rc> during rpi post operation

Error is encountered while posting the RPI header region into the firmware.

ACTION: Report the error to Broadcom Technical Support.

2758 Failed to allocate mbox for READ_FCF cmd

Memory for the READ_FCF command is not allocated.

ACTION: Report the error to Broadcom Technical Support.

0451 Adapter did not grant BlockGuard

The adapter firmware did not allow the driver to enable BlockGuard support. It is not a fatal error.

ACTION: No action required.

0599 Firmware Dump Image Present on Adapter

Driver identified that a firmware dump image is present.

ACTION: No action required.

2616 txcmplq not empty<cnt> after <maxwait>

The completion queue is not yet drained after a particular time.

ACTION: No action required.

3468 Memory Allocated failed for FW logging

The memory is unavailable to store the firmware log buffer.

ACTION: Report the error to Broadcom Technical Support.

2610 FCF <fcf_index> reached driver's book keeping dimension:< LPFC_SLI4_FCF_TBL_INDX_MAX>

The FCF index is beyond the driver allocated FCF table.

ACTION: Report the error to Broadcom Technical Support.

2920 Failed to alloc Resource IDs rc = <rc>

The port resources allocation itself has failed.

ACTION: Report the error to Broadcom Technical Support.

2925 Failed to issue CT ABTS RSP <Rctl> on xri <oxid>, Data <link_state>

The driver has failed to issue a common transport abort sequence response command.

ACTION: Report the error to Broadcom Technical Support.

3154 BLS ABORT RSP failed, data: <ulpStatus><iocb.un.ulpWord[4]>

The BLS ABORT response command has failed.

ACTION: Report the error to Broadcom Technical Support.

0283 Failed to allocate mbox cmd memory

The memory allocation from the mailbox slab has failed.

ACTION: Report the error to Broadcom Technical Support.

3169 Abort failed: Abort INP: Data: <sli4_xritag> <ulpIoTag> <ulpContext> <ulpCommand>

An abort is issued to the command for which an abort has already been issued.

ACTION: No action required.

3167 Abort failed: issue_iocb: Data: <sli4_xritag> <ulpIoTag> <ulpContext> <ulpCommand>

The driver has failed to post the abort request for a command.

ACTION: Report the error to Broadcom Technical Support.

2800 Ring <ringno> full - portCmdGet <local_getidx>, ring max <port_max_cmd>

The ring to post the pending commands is full.

ACTION: No action required.

3161 Failure to post els sgl to port.

The driver has failed to post the Extended Link Service SGL to the firmware.

ACTION: Report the error to Broadcom Technical Support.

0343 Ring <ringno> Cannot find buffer for an unsolicited iocb. tag <ulpWord[3]>

The driver does not have a buffer for processing an unsolicited command.

ACTION: No action required.

0342 Ring <ringno> Cannot find buffer for an unsolicited iocb. tag <sli3Words[7]>

The driver does not have a buffer for processing an unsolicited command.

ACTION: No action required.

0341 Ring <ringno> Cannot find buffer for an unsolicited iocb. tag <ulpWord[3]>

The driver does not have a buffer for processing an unsolicited command.

ACTION: No action required.

0340 Adapter temperature is OK now. temperature : <temperature> Celsius

The adapter has reported the temperature through an asynchronous event.

ACTION: No action required.

0347 Adapter is very hot, please take corrective action. temperature : %d Celsius, temperature
Adapter temperature is above normal range.

ACTION: Shutdown and remove the HBA. Contact Broadcom Technical Support.

0346 Ring <ringno> handler: unexpected ASYNC_STATUS evt_code <evt_code> W0 <iocb_w[0]> W1 <iocb_w[1]>
W2 <iocb_w[2]> W3 <iocb_w[3]> W4 <iocb_w[4]> W5 <iocb_w[5]> W6 <iocb_w[6]> W7 <iocb_w[7]> W8
<iocb_w[8]> W9 <iocb_w[9]> W10 <iocb_w[10]> W11 <iocb_w[11]> W12 <iocb_w[12]> W13 <iocb_w[13]> W14
<iocb_w[14]> W15 <iocb_w[15]>

The HBA received an asynchronous event that was not a temperature event.

ACTION: No action required.

0345 Resetting board, <event>

A mailbox command failed to complete. The driver is resetting the port.

ACTION: Report the error to Broadcom Technical Support.

0344 Ring <ringno> Cannot find buffer for an unsolicited iocb. tag <sli3Words[7]>

There are no more pre-allocated buffers available to handle unsolicited buffers.

ACTION: No action required.

2561 Allocated DMA memory size <allocLen> is less than the requested DMA memory size <reqLen>

Could not get the memory required for the number of XRIs that are attempting to be posted.

ACTION: No action required.

3033 Allocated DMA memory size <allocLen> is less than requested <reqLen>

Could not get the memory required for posting a read object mailbox command.

ACTION: No action required.

0349 rc should be MBX_SUCCESS

The next mailbox command on the mailbox queue has failed.

ACTION: No action required.

3367 LYPD Memory Allocation Failed for FW Logging

The DMA memory allocation for getting firmware logging has failed.

ACTION: No action required.

2564 POST_SGL_BLOCK mailbox command failed status <shdr_status> add_status <shdr_add_status> mbx status <rc>

The list of XRI SGEs failed to be registered with the firmware.

ACTION: No action required.

3362 LUN queue depth changed from <cfg_lun_queue_depth> to <rc>

The user configured LUN queue depth is beyond the allowable value. Reset the value to the maximum allowable value.

ACTION: No action required.

0582 Error <Status string> during els sgl post operation

The driver has failed to post the Extended Link Service SGL to the firmware.

ACTION: Report the error to Broadcom Technical Support.

3089 Failed to allocate queues

The driver has failed to allocate the queue required for posting the command requests.

ACTION: Report the error to Broadcom Technical Support.

3084 Allocated DMA memory size <allocLen> is less than the requested DMA memory size <reqLen>

Could not get enough memory to read the port attributes.

ACTION: No action required.

2001 Unable to allocate memory for issuing SLI_CONFIG_SPECIAL mailbox command

The memory allocation for the SLI_CONFIG_SPECIAL mailbox command has failed.

ACTION: Report the error to Broadcom Technical Support.

2512 MODIFY_EQ_DELAY mailbox failed with status <shdr_status> add_status <shdr_add_status>, mbx status <rc>

The mailbox command to modify the interrupt coalescing status has failed.

ACTION: No action required.

1806 Mbox <mbxCommand> failed. No vport

The mailbox command posting failed because it does not have the vPort information.

ACTION: No action required.

3024 Read Object mailbox failed with status <shdr_status> add_status <shdr_add_status>, mbx status <rc>

The read object mailbox is failed by the firmware.

ACTION: No action required.

2015 Invalid CT <ulpCt> command <ulpCommand>

Invalid command-type in the IOCB is not supported.

ACTION: No action required.

0410 Cannot find virtual addr for mapped buf on ring <ringno> Data <phys_addr> <postbufq_next> <postbufq_prev> <postbufq_cnt>

The driver cannot find the specified buffer in its mapping table. Therefore, it cannot find the virtual address needed to access the data.

ACTION: This error could indicate a software driver or firmware issue. If this issue persists, report these errors to Broadcom Technical Support.

7646 HA Read Err: HA: <HAreghaddr>

Failed to read the host attention register.

ACTION: No action required.

7645 Read failure HS: %p MB: %p\n, (void *)phba->HSregaddr, (void *)phba->MBslimaddr)

Failed to read the host status register.

ACTION: No action required.

3175 Abort IGNORED: Data: <sli4_xritag> <ulpIoTag> <ulpContext> <ulpCommand>

As the driver is being unloaded, the request to abort the outstanding commands is ignored.

ACTION: No action required.

3282 Invalid provisioning of vfi: <count>

The firmware reported an invalid value for the port resource VFI.

ACTION: This error could indicate a firmware issue. If this issue persists report these errors to Broadcom Technical Support.

3281 Invalid provisioning of xri: <count>

The firmware reported an invalid value for the port resource XRI.

ACTION: This error could indicate a firmware issue. If this issue persists, report these errors to Broadcom Technical Support.

3280 Invalid provisioning of vpi: <count>

The firmware reported an invalid value for the port resource VPI.

ACTION: This error could indicate a firmware issue. If this issue persists, report these errors to Broadcom Technical Support.

0809 <function_name>: out of buffers! Failing completion.

The driver has failed to get the IOCB buffer.

ACTION: No action required.

0376 READ_REV Error. SLI Level <sli_rev> FCoE enabled <hba_flag & HBA_FCOE_MODE>

The SLI revision reported by the firmware for this port is invalid.

ACTION: This error could indicate a software driver or firmware issue. If this issue persists, report these errors to Broadcom Technical Support.

0377 Error <rc> parsing vpd. Using defaults.

Could not parse the VPD data, so the driver is using the default values.

ACTION: No action required.

2823 txq empty and txq_cnt is <txq_cnt>

No more pending commands in the transaction wait queue.

ACTION: No action required.

0370 Invalid completion queue type <type>

The event queue entry is not for a mailbox or a work queue entry.

ACTION: No action required.

3370 FW LOG mailbox completed with status <shdr_status> add_status <shdr_add_status>, mbx status <mbxStatus>

Enabling firmware logging in host memory failed.

ACTION: No action required.

2752 KILL_BOARD command failed retval <retval>

The KILL_BOARD mailbox command is failed by the firmware.

ACTION: Report the error to Broadcom Technical Support.

2022 INIT VPI Mailbox failed status <rc>, mbxStatus <lpfc_mqe_status>

The INIT VPI mailbox command has failed.

ACTION: No action required.

2751 Adapter failed to restart, status reg <status>, FW Data: A8 <offset_A8> AC <offset_AC>

The adapter initialization has failed.

ACTION: Try to reset the port. If this issue persists, report the error to Broadcom Technical Support.

2515 ADD_FCF_RECORD mailbox failed with status <rc>

The mailbox command to add the FCF record has failed.

ACTION: No action required.

2510 RQ_DESTROY mailbox failed with status <shdr_status> add_status <shdr_add_status>, mbx status <rc>

The mailbox command sent to delete the work queue has failed.

ACTION: No action required.

2511 POST_SGL mailbox failed with status <shdr_status> add_status <shdr_add_status>, mbx status <rc>

The mailbox command sent to post the SGL pages to the firmware has failed.

ACTION: No action required.

0572 iotag <iotag> out of range, Max is <last_iotag>

The I/O tag in the completed IOCB is out of range.

ACTION: This error could indicate a software driver, firmware, or a hardware issue. Report the error to Broadcom Technical Support.

2513 POST_SGL_BLOCK mailbox command failed status <shdr_status> add_status <shdr_add_status> mbx status <rc>

The mailbox command sent to post the SGL pages to the firmware has failed.

ACTION: No action required.

2860 SLI authentication is required for INIT_LINK but has not done yet

The INIT_LINK mailbox command has failed, and the link may not be up.

ACTION: Report the error to Broadcom Technical Support.

0390 iotag <iotag> does not map to outstanding IO. last cmd <ulpCommand>, XRI <sli4_xritag>, wqid <fcq_wqid>, flag <iocb_flag>

The I/O tag does not map to the outstanding I/O list of the driver.

ACTION: This error could indicate a software driver, firmware, or hardware issue. Report the error to Broadcom Technical Support.

1807 IOCB <> failed. No vport

The IOCB does not have the vPort reference in it.

ACTION: This is a software issue. Report the error to Broadcom Technical Support.

6771 PCIe Read from <addr> succeeded after <retry_cnt> attempts

The PCIe read of an address succeeded after certain number of attempts.

ACTION: No action required.

2402 Failed to allocate xri for ELS sgl

Failed to allocate XRI for the Extended Link Service command.

ACTION: This is a software driver error. If this issue persists, contact Broadcom Technical Support.

6114 Allocate <bcnt> out of <num_to_alloc> requested new IO buffers

Number of I/O buffers allocated.

ACTION: No action required.

6134 insufficient XRI <io_xri_max> xri_split <cfg_xri_split>

Insufficient XRI for I/O pool. The driver retries with reduced I/O pool size.

ACTION: The driver should recover from this situation. If the port does not come up, report the error to Broadcom Technical Support.

0367 Slow-path CQ identifier (<id>) does not exist

This error is non fatal.

ACTION: No action required.

0372 Invalid completion queue type <queue_type>

LPFC detected an invalid completion queue type.

ACTION: If this issue persists, contact Broadcom Technical Support.

0411 Failed to alloc memory for Congestion Info

Unable to allocate memory for congestion buffer. LPFC will try to disable this feature and continue.

ACTION: Report the error to Broadcom Technical Support.

0419 Failed to alloc memory for Congestion Info

Unable to allocate memory for congestion buffer. LPFC will try to disable this feature and continue.

ACTION: Report the error to Broadcom Technical Support.

0549 Failed setup of FOF Queues: rc = <return code>

Queue setup failed, which will result in purging of all the queues setup by the driver and the HBA will not be functional.

ACTION: Report the error to Broadcom Technical Support.

2226 Received RDF from invalid DID <did>

Register diagnostic functions can only be received from the switch.

ACTION: Report the error to Broadcom Technical Support.

2621 Failed to RDF_ACC from <remote_did> for <initiator_did>
RDF ELS failed.

ACTION: Report the error to Broadcom Technical Support.

2623 Failed to re register RDF for <initiator_did>
Failed to issue RDF ELS. Report the issue to Broadcom technical support.

ACTION: No action required.

2645 Failed to alloc memory for RX Monitor Buffer
Unable to allocate memory for RX table (congestion) resulting in HBA not being initialized.

ACTION: Report the error to Broadcom Technical Support.

2999 Get SLI4 Parameters failed
LPFC Driver will not be initialized and hence will not be functional.

ACTION: Report the error to Broadcom Technical Support.

4576 PLOGI ACC fails discovery <error code>
PLOGI for point-to-point has failed. LUNs (if any) will not be visible.

ACTION: Report the error to Broadcom Technical Support.

4657 FPIN CONGESTION <notification_type> type <event_name> (<congestion event>) Event Duration <time>
mSecsOnly

If congestion_event == 1 or 2 it should be treated as an error.

ACTION: Report the error to Broadcom Technical Support.

4667 Error reading Cgn Params (<error code>)
Unable to read congestion parameters from firmware.

ACTION: Report the error to Broadcom Technical Support.

4669 FW cgn parm buf wrong magic <magic_value> version <version>
Invalid data received from firmware.

ACTION: Report the error to Broadcom Technical Support.

4670 CGN RD OBJ returns no data
Unable to read congestion parameters from firmware.

ACTION: Report the error to Broadcom Technical Support.

4673 CGN Event empty object
No data in congestion objects read from firmware.

ACTION: Report the error to Broadcom Technical Support.

4678 unknown FPIN descriptor:<fpin_descriptor_value>
Unknown FPIN descriptor detected.

ACTION: Report the error to Broadcom Technical Support.

4682 got invalid bytes_remain <remaining_bytes>
Invalid buffer length.

ACTION: Report the error to Broadcom Technical Support.

4919 Unknown Desc Tag <descriptor_tag>

Received invalid descriptor tag.

ACTION: Report the error to Broadcom Technical Support.

5120 Bad FPIN list length <actual_length> : <expected_length>

Actual length cannot be greater than expected length.

ACTION: Report the error to Broadcom Technical Support.

5342 vmk_StoragePollCreate failed <status> <index>

During HBA initialization failed to initialize polling.

ACTION: Report the error to Broadcom Technical Support.

5343 failed vmk_StoragePollCreate failed <status> <index>

During HBA initialization failed to initialize polling.

ACTION: Report the error to Broadcom Technical Support.

5346 time <time in milliseconds> retry <retry count> pendq_cnt <pending nvme io count>

Displays pending I/O count, if logs are flooded with these messages.

ACTION: Report the error to Broadcom Technical Support.

6223 Signal CMF init

Indicates that congestion is being turned on.

ACTION: No action required.

6232 CMF acr_min_rxbw param out of range: <value>

Bandwidth (in units of 5%) is out of range.

ACTION: Provide a value within the range.

6251 Error reading Cgn Params (<error code>)

Unable to read congestion parameters. Congestion will not be enabled.

ACTION: Report the error to Broadcom Technical Support.

6252 CGN Event empty object.

Ignore if end-to-end congestion not enabled.

Action: If end-to-end congestion is enabled, report the error to Broadcom Technical Support.

6707 state <event_state> - Unexpected

While an event is getting deferred its state should be 0. This is a nonfatal error.

ACTION: Report the error to Broadcom Technical Support.

6135 insufficient XRI's "no_of_pool <no_of_pool> per_cpu_xri <per_cpu_xri> io_xri_max<io_xri_max>
hba_queue_depth low value and is not sufficient for the driver to run NVMe I/Os. NVMe is disabled.

ACTION: Try with default settings, if this issue persists, contact Broadcom Technical Support.

Chapter 5: Troubleshooting the NVMe Driver

NVMe over FC on VMware ESXi 7.0 might operate in an unexpected manner in certain circumstances. This chapter describes such situations and their potential resolutions. This chapter also provides information about NVMe-related `esxcli` commands that are used in resolving issues.

5.1 Troubleshooting the NVMe Driver

Table 9: Troubleshooting the NVMe Driver

Situation	Resolution
<p>An NVMe namespace is not available:</p> <ul style="list-style-type: none"> ■ In the vSphere Client, the Devices tab under Storage does not list the namespace. ■ In the CLI, the command <code>esxcli nvme namespace list</code> does not show the namespace. 	<ul style="list-style-type: none"> ■ Make sure a controller is configured and visible. See Section 5.2.1, Checking the Status of an NVMe Controller, for details on how to list the controllers. Refer to the target documentation for more details. ■ Make sure that the FC zones are properly configured. Refer to the switch documentation for more details. ■ Make sure that the driver parameter <code>lpfc_enable_fc4_type</code> is set to 3. Refer to the <i>Emulex Drivers for VMware ESXi User Guide</i> for more details.
<p>NVMe paths in the device path list or in the Paths tab of the Storage adapter dialog appear as dead paths. In addition, messages similar to the following appear in the <code>/var/log/vmkernel.log</code> file:</p> <ul style="list-style-type: none"> ■ Error claiming path <code>vmhba <path_name></code> ■ cannot claim path <code><path_name></code> to 4K device 	<p>Change the target VMFS block size for the namespace to 512 bytes.</p>
<p>In a multipath environment, NVMe paths in the device path list or in the Paths tab of the Storage adapter dialog appear as dead paths.</p> <p>If you run the <code>esxcfg-mpath -b</code> command (see Section 5.2.5, Viewing Multipath Information), LUNs appear as dead, and adapters and targets appear as Unavailable.</p> <p>If you run the <code>esxcli nvme controller list</code> command, NVMe controllers appear as offline.</p> <p>In addition, messages similar to the following appear in the <code>/var/log/vmkernel.log</code> file:</p> <ul style="list-style-type: none"> ■ 0214 RSCN received Data: <code><data></code> ■ 5973 RSCN received event <code><event></code> ■ Start 10 sec devloss ■ keep alive IO error <code><error></code> ■ Request to start controller <code><controller_number></code> recovery 	<p>To bring a path online, verify its target configuration and zone setting, and adjust them as needed.</p> <p>NOTE: If some target ports are down, multipathing allows I/O to fail over to active paths.</p>
<p>A newly added NVMe controller is not visible. Stale entries cannot be removed by a rescan.</p>	<p>Perform an initiator port link reset. For example, you can issue a LIP to an initiator port by typing the following command:</p> <pre>/usr/lib/vmware/vmkmgmt_keyval/vmkmgmt_keyval -i <vmhba>/ Emulex -k adapter -s lip</pre> <p>where <code><vmhba></code> is the HBA number.</p>

5.2 Using VMware Commands

This section provides information about VMware commands that you can use in troubleshooting NVMe issues.

5.2.1 Checking the Status of an NVMe Controller

To check the status of an NVMe controller, perform the following steps:

1. If necessary, determine the mapping between an NVMe namespace and an NVMe controller by typing the following command:

```
esxcli nvme namespace list
```

Information similar to the following is displayed:

Name	Controller Number	Namespace ID	Block Size	Capacity in MB
uuid.cfb11df2e43a49779293f41319de4fb0	259	1	512	5120
uuid.cfb11df2e43a49779293f41319de4fb1	259	2	512	5120
uuid.cfb11df2e43a49779293f41319de4fb2	259	3	512	5120
uuid.cfb11df2e43a49779293f41319de4fb3	259	4	512	5120
uuid.cfb11df2e43a49779293f41319de4fb4	259	5	512	5120
uuid.cfb11df2e43a49779293f41319de4fb5	259	6	512	5120
uuid.cfb11df2e43a49779293f41319de4fb6	259	7	512	5120
uuid.cfb11df2e43a49779293f41319de4fb7	261	1	512	5120
uuid.cfb11df2e43a49779293f41319de4fb8	259	8	512	102400
uuid.cfb11df2e43a49779293f41319de4fb9	261	2	512	5120
uuid.cfb11df2e43a49779293f41319de4fba	261	3	512	5120
uuid.cfb11df2e43a49779293f41319de4fdb	259	9	512	5120

You can obtain the NVMe controller number for the specific namespace from the displayed information.

NOTE: If the desired namespace is not listed, verify that the controller is connected (see the next step), the target is connected (see [Section 5.2.2, Verifying that NVMe Target Ports Are Discovered](#)), and NVMe is configured properly ([Section 5.2.3, Listing NVMe Adapters on an ESXi Host](#)).

2. To view the NVMe controller status, type the following command:

```
esxcli nvme controller list
```

Information similar to the following is displayed:

Name	Con- troller Number	Adapter	Trans- -port Type	Is Online
nqn.1992-08.com.netapp:sn.54a936ec00ac11ea829d00a0986e444a:subsystem.nvmevs_amesxi7_ss01#vmhba64#203c00a0986e4449:203e00a0986e4449	262	vmhba64	FC	true
nqn.1992-08.com.netapp:sn.54a936ec00ac11ea829d00a0986e444a:subsystem.nvmevs_amesxi7_ss01#vmhba66#203c00a0986e4449:203e00a0986e4449	264	vmhba66	FC	true
nqn.1992-08.com.netapp:sn.54a936ec00ac11ea829d00a0986e444a:subsystem.nvmevs_amesxi7_ss01#vmhba67#203c00a0986e4449:203e00a0986e4449	265	vmhba67	FC	true
nqn.1992-08.com.netapp:sn.54a936ec00ac11ea829d00a0986e444a:subsystem.nvmevs_amesxi7_ss01#vmhba65#203c00a0986e4449:203e00a0986e4449	263	vmhba65	FC	true
nqn.1992-08.com.netapp:sn.54a936ec00ac11ea829d00a0986e444a:subsystem.nvmevs_amesxi7_ss01#vmhba64#203c00a0986e4449:206600a0986e4449	392	vmhba64	FC	true
nqn.1992-08.com.netapp:sn.54a936ec00ac11ea829d00a0986e444a:subsystem.nvmevs_amesxi7_ss01#vmhba66#203c00a0986e4449:206600a0986e4449	391	vmhba66	FC	true
nqn.1992-08.com.netapp:sn.54a936ec00ac11ea829d00a0986e444a:subsystem.nvmevs_amesxi7_ss01#vmhba65#203c00a0986e4449:206600a0986e4449	393	vmhba65	FC	true
nqn.1992-08.com.netapp:sn.54a936ec00ac11ea829d00a0986e444a:subsystem.nvmevs_amesxi7_ss01#vmhba67#203c00a0986e4449:206600a0986e4449	394	vmhba67	FC	true

3. Locate the controller you identified in [Step 1](#). Its status is listed under `Is Online`.

5.2.2 Verifying that NVMe Target Ports Are Discovered

The following variables are used in this section:

- `<vmhba>` is the HBA number.

To list the NVMe target ports that are discovered by an initiator HBA port, type the following command:

```
/usr/lib/vmware/vmkmgmt_keyval/vmkmgmt_keyval --instance <vmhba>/Emulex --get --key node
```

Information similar to the following is displayed:

Key `node`:

lpfc Node page:

WWNN	WWPN	SCSI ID DID	Type	Status
10:00:00:05:33:7f:2f:56	20:0e:00:05:33:7f:2f:56	xxxxffe	Fabric	Node ok
10:00:00:05:33:7f:2f:56	21:fc:00:05:33:7f:2f:56	xxxxffc	Fabric	Node ok
20:3c:00:a0:98:6e:44:49	20:3e:00:a0:98:6e:44:49	xcf1503	Target	Node ok

5.2.3 Listing NVMe Adapters on an ESXi Host

To list the NVMe adapters on an ESXi host, type the following command:

```
esxcli nvme adapter list
```

Information similar to the following is displayed:

Adapter	Adapter Qualified Name	Transport Type	Driver	Associated Devices
vmhba32	aqn:lpfc:100000109b8f2bea	FC	lpfc	
vmhba33	aqn:lpfc:100000109b8f2beb	FC	lpfc	
vmhba34	aqn:lpfc:10000090fa9488c9	FC	lpfc	
vmhba35	aqn:lpfc:10000090fa9488ca	FC	lpfc	

5.2.4 Discovering NVMe Controllers Connected to Target Ports

The following variables are used in this section:

- `<vmhba>` is the ESXi Host HBA number.
- `<wwpn>` is the WWPN of the target HBA.
- `<wwnn>` is the WWNN of the target HBA.

To list the NVMe controllers that are connected to target ports, type the following command:

```
esxcli nvme fabrics discover -a <vmhba> -w <wwpn> -W <wwnn> -c
```

Information similar to the following is displayed:

Trans- port Type	Address Family	Sub- system Type	Controller ID	Admin Queue Max Size	Transport Address	Trans- port Service ID	Subsystem NQN	Con- nected
Fibre Channel	Fibre Channel	NVM	65535	32	nn- 0x203c00a0986e4449 :pn- 0x203e00a0986e4449	None	nqn.1992- 08.com.netapp:sn.54a936ec0 0ac11ea829d00a0986e444a:su bssystem.nvmevs_paramesxi7_ ss01	True

5.2.5 Viewing Multipath Information

To view multipath information, type the following command:

```
esxcfg-mpath -b
```

Information similar to the following is displayed:

```
uuid.a597cb7a665c410e88e59f3a3d4c134e : NVMe Fibre Channel Disk
(uuid.a597cb7a665c410e88e59f3a3d4c134e)
  vmhba32:C0:T0:L0 LUN:0 state:active fc Adapter: WWNN: 20:00:00:10:9b:8f:2b:ea WWPN:
10:00:00:10:9b:8f:2b:ea Target: WWNN: 20:3c:00:a0:98:6e:44:49 WWPN: 20:3e:00:a0:98:6e:44:49
  vmhba33:C0:T1:L0 LUN:0 state:standby fc Adapter: WWNN: 20:00:00:10:9b:8f:2b:eb WWPN:
10:00:00:10:9b:8f:2b:eb Target: WWNN: 20:3c:00:a0:98:6e:44:49 WWPN: 20:66:00:a0:98:6e:44:49
  vmhba33:C0:T0:L0 LUN:0 state:active fc Adapter: WWNN: 20:00:00:10:9b:8f:2b:eb WWPN:
10:00:00:10:9b:8f:2b:eb Target: WWNN: 20:3c:00:a0:98:6e:44:49 WWPN: 20:3e:00:a0:98:6e:44:49
  vmhba32:C0:T1:L0 LUN:0 state:standby fc Adapter: WWNN: 20:00:00:10:9b:8f:2b:ea WWPN:
10:00:00:10:9b:8f:2b:ea Target: WWNN: 20:3c:00:a0:98:6e:44:49 WWPN: 20:66:00:a0:98:6e:44:49
```

5.3 NVMe Driver Error Log Messages and Their Descriptions

```
0527: Failed setup of fast-path FCP NVMe WQ/CQ <cqidx>, rc = <ret_val>
```

The fast-path FCP completion queue setup failed.

ACTION: The driver fails to load. Contact Broadcom Technical Support.

```
6095 buffer pool is empty abort_cnt <abort_cnt> nvme_abort
```

Failed to get buffer for I/O.

ACTION: This is a software driver error. If this issue persists, contact Broadcom Technical Support.

```
6067 No match <port_name>
```

No matching port name found for NVMe discovery of port name.

ACTION: No action required.

```
6070 Mismatch of param_wwnn
```

Port name and node name mismatch while NVMe discovery of port name.

ACTION: Check the fabric configuration.

```
6066 NVME req <lpfc_nbuf> nvmeCmd
```

NVMe I/O aborts for lpfc_nbuf.

ACTION: No action required.

```
6002 Abort Request to rport DID <nlp_DID>
```

Aborting NVMe command.

ACTION: No action required.

Appendix A: esxcli Management Tool

A.1 Usage

The esxcli management tool supports both local and remote management.

- Local management

```
esxcli elxmgmt <command> <parameters>
```

- Remote management

To manage the ESXi system directly, use the following command:

```
esxcli -s <server> -u <username> -p <password> -d <thumbprint> elxmgmt <command> <parameters>
```

To manage the ESXi system using a vCenter server, use the following command:

```
esxcli -s <vCenter_server> -u <username> -p <password> -h <VI_HOST> -d <thumbprint> elxmgmt <command> <parameters>
```

Table 10: Available Namespaces

Namespace	Description
authconfig	Authentication features of an Emulex FC HBA.
driverparams	Driver parameters of an Emulex FC HBA.
hba	HBA associated features of an Emulex FC HBA.
hbaport	Port associated features of an Emulex FC HBA.
beacon	Beacon state of an Emulex FC HBA.
bootparams	Boot parameters for a given port and given boot type for an Emulex FC HBA.
dumpdirectory	Dump file directory for an Emulex FC HBA in the host.
fwlog	Firmware logging for a particular port of an Emulex FC HBA.
fwparams	Firmware parameters of an Emulex FC HBA.
trunkinfo	Trunking operations for an LPe35000-series or LPe36000-series adapter.
version	Returns the version of the tool and dependent libraries.
wwn	Performs WNN management related operations.
xcvrdata	Transceiver data of an Emulex FC HBA.
congestparams	Congestion management of an Emulex FC HBA.

A.2 esxcli Management Commands

The commands listed in this section are for local management only. You can add the remote management parameters to the local commands for remote management.

The following table contains a list of esxcli management commands and their descriptions.

Table 11: esxcli Management Commands

Command	Description
<code>authconfig delete -w <initiator wwpn></code>	Sets delete authentication for a specified HBA port.
<code>authconfig get -w <initiator wwpn></code> <code>-d <target wwpn></code>	Shows the authentication configuration details. <ul style="list-style-type: none"> ■ <code>d</code> specifies the destination WWPN. It must be <code>ff:ff:ff:ff:ff:ff:ff:ff</code> for a switch or the actual WWPN for a target.
<code>authconfig initiate -w <initiator wwpn></code> <code>-d <target wwpn></code>	Initiates authentication for a specified HBA port. <ul style="list-style-type: none"> ■ <code>d</code> specifies the destination WWPN. It must be <code>ff:ff:ff:ff:ff:ff:ff:ff</code> for a switch or the actual WWPN for a target.
<code>authconfig lst -w <wwpn></code>	Shows the authentication configuration list.
<code>authconfig remove -w <wwpn></code> <code>-e <entity pair></code>	Sets delete authentication from an entity pair for a specified HBA port. <ul style="list-style-type: none"> ■ <code>e</code> specifies the entity pair: (localEntity, remoteEntity) <ul style="list-style-type: none"> - localEntity: Source WWPN. - remoteEntity: Destination WWPN or all. - all deletes the entire authentication configuration.
<code>authconfig secret set -w <initiator wwpn></code> <code>-d <target wwpn> -f <flag></code> <code>-t <new secret type></code> <code>-v <new secret value></code>	Sets the authentication configuration password for a specified HBA port. <ul style="list-style-type: none"> ■ <code>d</code> specifies the destination WWPN. It must be <code>ff:ff:ff:ff:ff:ff:ff:ff</code> for a switch or the actual WWPN for a target. ■ <code>f</code> specifies the flag. Valid values are (1, 2). <ul style="list-style-type: none"> - 1 = Local; the password is used when the HBA initiates authentication to the switch and when using bidirectional authentication. - 2 = Remote; the password is used when the switch initiates authentication to the HBA and, when using bidirectional authentication, the remote password must be set. ■ <code>t</code> specifies the new secret type. Valid values are (1, 2). <ul style="list-style-type: none"> - 1 = ASCII. - 2 = Hexadecimal (binary). <code>v</code> specifies the new secret value.

Table 11: esxcli Management Commands (Continued)

Command	Description
<pre>authconfig set -w <initiator wwpn> -d <target wwpn> -b <bi-directional> -p <dh-priority> -s <hash-priority> -m <mode> -r <re-authentication> -a <re-authentication-interval> -t <timeout></pre>	<p>Sets the authentication configuration parameters for a specified HBA port.</p> <ul style="list-style-type: none"> ■ d specifies the destination WWPN. It must be <code>ff:ff:ff:ff:ff:ff:ff:ff</code> for a switch or the actual WWPN for a target. ■ b specifies bidirectional. Valid values are (disabled, enabled). ■ p specifies dh-priority: (1, 2, 3, 4, 5), any combinations up to five digits. (4321 specifies a priority of 1536:1280:1024:Null). <ul style="list-style-type: none"> 1 = Null 2 = 1024 3 = 1280 4 = 1536 5 = 2048 ■ s specifies the hash-priority. Valid values are (md5, sha1). <ul style="list-style-type: none"> md5 = First md5, then sha1. sha1 = First sha1, then md5. ■ m specifies the mode. Valid values are (disabled, enabled, passive). ■ r specifies the re-authentication mode. Valid values are (disabled, enabled). ■ a specifies the re-authentication time interval in minutes. Valid values are (0, 10 to 3, 600). <ul style="list-style-type: none"> 0 = Disables re-authentication. <p>t specifies the timeout value in seconds.</p>
<pre>authconfig status get -w <initiator wwpn> -d <target wwpn></pre>	<p>Shows the authentication configuration status details.</p> <ul style="list-style-type: none"> ■ d specifies the destination WWPN. It must be <code>ff:ff:ff:ff:ff:ff:ff:ff</code> for a switch or the actual WWPN for a target.
<pre>beacon get -w <wwpn></pre>	<p>Shows the beacon state of an Emulex FC HBA.</p>
<pre>beacon set -w <wwpn> -s <state> [-d <duration>]</pre>	<p>Sets the beacon state of an Emulex FC HBA.</p> <ul style="list-style-type: none"> ■ s specifies the state of the beacon. The default is 1. Valid values are: <ul style="list-style-type: none"> – 1 = Beacon on (mandatory). – 0 = Beacon off. ■ d specifies the duration of beaconing. The maximum duration is 65,535 seconds. The default is 0 for infinite beaconing. This is an optional parameter.
<pre>bootparams get -w <wwpn> -t <boot type></pre>	<p>Shows the boot parameters for a given port and given boot type.</p> <ul style="list-style-type: none"> ■ t specifies the boot type: (X86, EFI, OB).

Table 11: esxcli Management Commands (Continued)

Command	Description
<pre>bootparams set -w <wwpn> -p <parameter> -t <type> -v <value> - b <boot_device></pre>	<p>Sets the boot parameter and boot type for the specified HBA port.</p> <ul style="list-style-type: none"> ■ p specifies the parameter name. ■ t specifies the boot type: {X86, EFI, OB}. ■ v specifies the value to be set for the parameter. <p>Parameter name, supported boot type, and valid values are as follows:</p> <ul style="list-style-type: none"> - DefaultAlpa <ul style="list-style-type: none"> X86/OB { Value } - EnableAdapterBoot <ul style="list-style-type: none"> All { State } (0=Disable, 1=Enable) - EnableBootFromSan <ul style="list-style-type: none"> All { State } (0=Disable, 1=Enable) - LinkSpeed <ul style="list-style-type: none"> All { 0, 1, 2, 4, 8 } - PlogiRetryTimer <ul style="list-style-type: none"> All { 0, 1, 2, 3 } - AutoScan <ul style="list-style-type: none"> X86 { 0, 1, 2, 3 } - AutoBootSectorEnable <ul style="list-style-type: none"> X86 { State } (0=Disable, 1=Enable) - EDD30Enable <ul style="list-style-type: none"> X86 { State } (0=Disable, 1=Enable) - EnvVarEnable <ul style="list-style-type: none"> X86 { State } (0=Disable, 1=Enable) - SpinupDelayEnable <ul style="list-style-type: none"> X86 { State } (0=Disable, 1=Enable) - StartUnitCommandEnable <ul style="list-style-type: none"> X86 { State } (0=Disable, 1=Enable) - BootTargetScan <ul style="list-style-type: none"> EFI { 0, 1, 2, 3, 4 } - EnableFABL <ul style="list-style-type: none"> EFI { State } (0=Disable, 1=Enable) - MaxLunsPerTarget <ul style="list-style-type: none"> EFI { Value }

Table 11: esxcli Management Commands (Continued)

Command	Description
	<ul style="list-style-type: none"> - DelayDeviceDiscovery EFI { Value } - SfsFlag OB - { State } (0=Disable, 1=Enable) <p>Boot Device Parameters</p> <ul style="list-style-type: none"> - D_ID All {Value [BootDev Value2]} - LUN All {Value [BootDev Value2]} - TargetWWPN All {Value [BootDev Value2]} - TargetID OB {Value } <ul style="list-style-type: none"> ■ b specifies the boot device entry number { 0 to 7 } as shown in the output of the <code>bootparams get</code> command.
<code>congestparams get -w <wwpn></code>	Shows the congestion parameters for a specified HBA port.
<code>congestparams set -w <wwpn> -p <parameter name> -v <parameter value></code>	<p>Sets the congestion parameters for a specified HBA port.</p> <ul style="list-style-type: none"> ■ p specifies the name of the congestion parameter whose value is to be set. Valid values are: <ul style="list-style-type: none"> - 0 = Off - 1 = Conservative - 2 = Moderate - 3 = Aggressive. - 4 = Monitor. ■ v specifies the new value for the specified congestion parameter. Valid values are: <ul style="list-style-type: none"> - 0 = Disable. - 1 = Enable.
<code>congestparams stats get -w <wwpn></code>	Shows the congestion statistics for a specified HBA port.
<code>congestparams stats reset -w <wwpn></code>	Resets the congestion statistics counters for a specified HBA port.
<code>driverparams defaults set -w <wwpn> -s <scope> -t <setting nature></code>	<p>Restores the driver parameter to the default value at the port or global level, either permanently or temporarily for the specified port.</p> <ul style="list-style-type: none"> ■ s specifies the scope. <ul style="list-style-type: none"> - L for local (specified adapter). - G for global (all adapters on the host). ■ t specifies the nature of the setting. <ul style="list-style-type: none"> - P for permanent (persists across reboot). - T for temporary.
<code>driverparams get -w <wwpn></code>	Shows the name and values of each parameter.
<code>driverparams global get -w <wwpn></code>	Shows the name and global values of each parameter.

Table 11: esxcli Management Commands (Continued)

Command	Description
<code>driverparams set -w <wwpn> -s <scope> -t [<setting nature> -p <parameter name> -v <value></code>	<p>Changes a driver parameter and designates the scope of the change.</p> <ul style="list-style-type: none"> ■ <code>s</code> specifies the scope. <ul style="list-style-type: none"> - <code>L</code> for local (specified adapter). - <code>G</code> for global (all adapters on the host). ■ <code>t</code> specifies the nature of setting. <ul style="list-style-type: none"> - <code>P</code> for permanent (persists across reboot). - <code>T</code> for temporary. ■ <code>p</code> specifies the parameter name. ■ <code>v</code> specifies the value to be set for the parameter. Enter a decimal value, or enter a hexadecimal value prefixed by <code>0x</code>.
<code>dumpdirectory get</code>	Displays the dump directory for the adapters in the host.
<code>dumpdirectory set -d <dump_directory></code>	<p>Sets the dump directory.</p> <p>A dump directory must be set before a dump can be created.</p> <p>NOTE: The dump directory must have a subdirectory under the <code>/vmfs/volumes</code> directory to store Emulex HBA Manager dumps, <i>and</i> the directory must exist at the time of setting. The directory path must not contain spaces.</p>
<code>firmware dump -w <wwpn></code>	<p>Creates a diagnostic dump for a selected adapter. Dump files contain information, such as the firmware version, driver version, and operating system information. This information is useful when troubleshooting an adapter. Text (<code>.txt</code> extension) and binary files (<code>.bin</code> extension) are created with the <code>dump</code> command.</p> <p>NOTE: The dump directory must be explicitly set before a dump operation can succeed. If a dump operation is performed without setting a dump directory, an error message is displayed. For information on setting a dump directory, see the <code>dumpdirectory set</code> command.</p> <p>NOTE: If there are multiple dumps in the flash memory of an adapter, the command generates multiple <code>.txt</code> and <code>.bin</code> files.</p>
<code>fwlog get -w <wwpn></code>	Stops the firmware log capture, retrieves the log to the dump directory, and restarts firmware log captures for a specified HBA port.
<code>fwlog set -w <wwpn> -l <log_level> -s <state></code>	<p>Starts or stops the firmware logging with the specified log level for a specified HBA port.</p> <ul style="list-style-type: none"> ■ <code>l</code> specifies the logging level of the firmware log. Valid values are 0 to 4. The log level determines the verbosity of the logs. 0 is the least verbose. ■ <code>s</code> specifies firmware logging. Valid values are: <ul style="list-style-type: none"> - <code>1</code> = Start firmware logging. - <code>0</code> = Stop firmware logging.
<code>fwparams get -w <wwpn></code>	Shows the firmware parameters that can be set from the management layer.

Table 11: esxcli Management Commands (Continued)

Command	Description
<code>fwparams set -w <wwpn> -p <parameter name> -v <parameter value></code>	<p>Sets the firmware parameters.</p> <ul style="list-style-type: none"> ■ <code>p</code> specifies the name of firmware parameter whose value is to be set. Valid values are: <ul style="list-style-type: none"> - FA-PWWN - FEC - DYNAMIC-DPORT - TOPOLOGY ■ <code>v</code> specifies the new value for the specified firmware parameter. Valid values are: <ul style="list-style-type: none"> - 0 = Disable. - 1 = Enable. <p>NOTE: For the parameter TOPOLOGY, the valid values are:</p> <ul style="list-style-type: none"> - 0 = Auto,(Loop First). - 1 = Auto,(PTP First) - 2 = Loop - 3 = PTP <p>NOTE: D_Port and FA-PWWN cannot be enabled simultaneously. If D_Port is enabled and you want to enable FA-PWWN, you must first disable D_Port. If FA-PWWN is enabled and you want to enable D_Port, you must first disable FA-PWWN.</p>
<code>hba attributes get -w <wwpn></code>	Lists HBA attributes of an Emulex FC HBA.
<code>hba firmware download -w <wwpn> -f <firmware pathname></code>	<p>Performs firmware download on to the adapter.</p> <ul style="list-style-type: none"> ■ <code>f</code> specifies the fully qualified path to the firmware file.
<code>hba list</code>	Lists the Emulex FC HBAs.
<code>hbaport allnodeinfo list -w <wwpn></code>	Shows the target node information for each target accessible by the adapter.
<code>hbaport attributes -w <wwpn></code>	Lists port attributes of an Emulex FC HBA.
<code>hbaport bootcode -w <wwpn> -s <state></code>	<p>Enables or disables boot code on the adapter port.</p> <ul style="list-style-type: none"> ■ <code>s</code> specifies the state of the boot code. Possible values are <code>E</code> and <code>D</code>. <ul style="list-style-type: none"> - <code>E</code> = Enable. - <code>D</code> = Disable.
<code>hbaport disable -w <wwpn> -p <portstate></code>	<p>Disables the adapter port for a specified HBA port.</p> <ul style="list-style-type: none"> ■ <code>p</code> specifies the port state as Disable 0. <p>NOTE: Ensure that all I/O on the port is stopped before disabling the port.</p> <p>NOTE: A port reset might be required to activate the new setting.</p>
<code>hbaport dporttest start -w <wwpn></code>	Runs a set of diagnostic tests that allows detection of physical cabling issues.
<code>hbaport echotest start -w <initiator wwpn> -d <target wwpn> -c <number of cycles> -s <stop on error flag> [-p pattern]</code>	<p>Runs the echo test. The <code>hbaport echotest start</code> command fails if the target WWPN does not support the ECHO Extended Link Service command.</p> <ul style="list-style-type: none"> ■ <code>d</code> specifies the destination WWPN. It must be <code>ff:ff:ff:ff:ff:ff:ff:ff</code> for a switch or the actual WWPN for a target. ■ <code>c</code> specifies the count or number of cycles (1...99999). ■ <code>s</code> specifies StopOnError: (0, 1). <ul style="list-style-type: none"> - 0 = Do not stop test on error. - 1 = Stop test on error. ■ <code>p</code> specifies a pattern with up to 8 hexadecimal characters (for example, 1a2b3c4d). This is an optional parameter. The number of cycles must be between 1 and 99,999. <p>NOTE: The <code><target wwpn></code> is the WWPN of the target port and can be obtained by running the <code>hbaport targetmapping list</code> command.</p>

Table 11: esxcli Management Commands (Continued)

Command	Description
<code>hbaport enable -w <wwpn> -p <portstate></code>	Enables the adapter port for a specified HBA port. <ul style="list-style-type: none"> ■ <code>p</code> specifies the port state as Enable 1. <p>NOTE: Ensure that all I/O on the port is stopped before enabling the port.</p> <p>NOTE: A port reset might be required to activate the new setting.</p>
<code>hbaport fctraceroute get -w <initiator wwpn> -d <target wwpn></code>	Shows the FC trace route details between the adapter port and the specified target port. <ul style="list-style-type: none"> ■ <code>d</code> specifies the destination WWP. It must be <code>ff:ff:ff:ff:ff:ff:ff:ff</code> for a switch or the actual WWP for a target.
<code>hbaport flashpart get -w <wwpn></code>	Displays the flash part of the specified HBA port.
<code>hbaport loopbacktest start -w <initiator wwpn> -d <target wwpn> -c <number of cycles> -s <stop on error flag> [-p <pattern>][-o <statistics option> -t <type>]</code>	Runs loopback tests on FC functions. <ul style="list-style-type: none"> ■ <code>d</code> specifies the destination WWP. It must be <code>ff:ff:ff:ff:ff:ff:ff:ff</code> for a switch or the actual WWP for a target. ■ <code>c</code> specifies the count or number of cycles (1....99999). Infinite loop is not supported. ■ <code>s</code> specifies StopOnError: (0, 1). <ul style="list-style-type: none"> – 0 = Do not stop test on error. – 1 = Stop test on error. ■ <code>p</code> specifies a pattern with up to 8 hexadecimal characters (for example, 1a2b3c4d). This is an optional parameter. The number of cycles must be between 1 and 99,999. ■ <code>o</code> specifies the link statistics option: (<code>stats</code>, <code>clearstats</code>). This is an advanced parameter that is optional. When <code>o</code> is specified, <code>t</code> must also be specified. Contact Broadcom Technical Support before you use this option. ■ <code>t</code> specifies the HBA test: (0, 1, 2) <ul style="list-style-type: none"> – 0 = PCI LoopBack test. – 1 = Internal LoopBack test. – 2 = External LoopBack test (requires loopback plug). <p>NOTE: The <code><target wwpn></code> is the WWP of the target port and can be obtained by running the <code>hbaport targetmapping list</code> command.</p>
<code>hbaport pcidata -w <wwpn></code>	Shows the PCI information of a specified HBA port.
<code>hbaport reset -w <wwpn></code>	Resets the FC function.
<code>hbaport speed set -w <wwpn> -s<speed></code>	Sets the port speed of an Emulex FC HBA. <ul style="list-style-type: none"> ■ <code>s</code> specifies the supported link speed. Use the <code>hbaport attributes</code> command to get a list of supported speed values. Specify a value of 0 to configure Auto Detect mode. <p>NOTE: A port reset is required to activate the new setting.</p>
<code>hbaport statistics -w <wwpn></code>	Lists port statistics of an Emulex FC HBA.
<code>hbaport statistics reset -w <wwpn></code>	Resets the FC port statistics.
<code>hbaport targetmapping list -w <wwpn></code>	Shows a list of mapped targets and the LUNs for the port.
<code>hbaport vpd get -w <wwpn></code>	Shows the VPD information of a specified HBA port.
<code>trunkinfo get -w <wwpn></code>	Shows the complete trunking configuration of a physical port or trunked port specified by the WWP on an LPe35000-series or LPe36000-series adapter.
<code>trunkinfo set -w <wwpn> -m <mode></code>	Specifies the type of trunking to use for a specified HBA port on an LPe35000-series or LPe36000-series adapter. <ul style="list-style-type: none"> ■ <code>m</code> specifies the trunking mode: (0, 1, 2) <ul style="list-style-type: none"> – 0 = Disables trunking on the adapter. – 1 = Enables 2-lane trunking. – 2 = Enables 4-lane trunking (only valid for four-port adapters)

Table 11: esxcli Management Commands (Continued)

Command	Description
<code>version</code>	Displays the version of different components.
<code>version get</code>	Shows the version of the tool and dependent libraries.
<code>wwn change -w <initiator wwpn> -d <target wwpn> -t <type></code>	Changes the WWPN for a specified HBA port. <ul style="list-style-type: none"> ■ <code>d</code> specifies the destination WWPN. It must be <code>ff:ff:ff:ff:ff:ff:ff:ff</code> for a switch or the actual WWPN for a target. ■ <code>t</code> specifies the type: (0, 1) <ul style="list-style-type: none"> - 0 = Volatile. - 1 = Non-volatile.
<code>wwn getcap -w <wwpn></code>	Shows the WWN management capabilities of a specified HBA port.
<code>wwn read -w <wwpn> -t <type></code>	Reads the current WWPN for a specified HBA port. <ul style="list-style-type: none"> ■ <code>t</code> specifies the type: (0, 1, 2, 3, 4) <ul style="list-style-type: none"> - 0 = Volatile. - 1 = Non-Volatile. - 2 = Factory Default - 3 = Current. - 4 = Configured.
<code>wwn restore -w <wwpn> -t <type></code>	Restores the WWPN for a specified HBA port. <ul style="list-style-type: none"> ■ <code>t</code> specifies the type: (0, 1) <ul style="list-style-type: none"> - 0 = Restore Default WWNs. - 1 = Restore NVRAM WWNs.
<code>xcvrdata get -w <wwpn> [-t <type>]</code>	Shows the transceiver data in raw or formatted output. <ul style="list-style-type: none"> ■ <code>t</code> specifies the type: (1, 2) <ul style="list-style-type: none"> - 1 = Formatted SFS data. - 2 = Raw SFS data. <p>This is an optional parameter.</p>

Appendix B: lpfc Driver BlockGuard Functionality

This appendix describes how to enable BlockGuard and set `lpfc` driver module parameters.

B.1 Overview

The BlockGuard feature checks the integrity of data read and written between the host and the disk through the SAN. This check is implemented through the DIF defined in the ANSI T10 standard.

The Emulex `lpfc` driver supports T10 DIF Type 1. In the Type 1 implementation, the 8-byte DIF consists of a Ref tag (or LBA), an App tag, and a Guard tag (or CRC). A Type 1 DIF is defined as having a 2-byte Guard tag, a 2-byte App tag, and a 4-byte Ref tag, which consist of the lower 32 bits of the LBA.

The following figure shows a data block (with a 512-byte sector) with the 8-byte footer attached to the end. The contents of the 8-byte footer are shown with the fields that make up the Type 1 DIF: the Guard tag, the App tag, and the Ref tag. The App tag is not used by the `lpfc` driver.

Figure 1: Data Block Showing Type 1 DIF

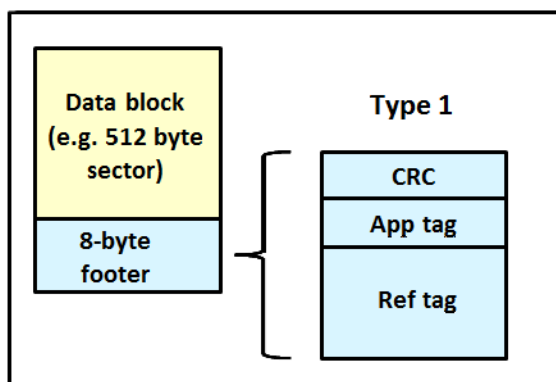

When data is written, the DIF is generated by the host, or by the adapter, based on the block data and the LBA. The DIF field is added to the end of each data block, and the data is sent through the SAN to the storage target. The storage target validates the CRC and Ref tag and, if correct, stores both the data block and DIF on the physical media. If the CRC does not match the data, the data was corrupted during the write. A Check Condition is returned to the host with the appropriate error code. The host records the error and retransmits the data to the target. In this way, data corruption is detected immediately on a write and is never committed to the physical media. On a read, the DIF is returned along with the data block to the host, which validates the CRC and Ref tags. Because this validation is done by the hardware, it adds a very small amount of latency to the I/O.

The format of the Guard tag can optionally be an IP checksum instead of the CRC mandated by the T10 DIF. This can be beneficial because the initiator host uses less CPU overhead to generate an IP checksum than it does with a CRC. The IP checksum is typically passed as the Guard tag between the initiator host and the adapter. The adapter hardware will translate the IP checksum into a CRC, or vice versa, on data being sent to or received from the wire. The CRC is called a DIF protection type, and the IP checksum is referred to as a DIX protection type.

B.2 Enabling BlockGuard

BlockGuard is disabled by default. To enable it, the parameter `lpfc_enable_bg` must be passed to the driver as follows:
`esxcli system module parameters set -m lpfc -p "lpfc_enable_bg=1"`

Additional module parameters can be added to this line, separated by spaces.

B.3 SCSI Command Support – SCSI Operation Codes

When there are both `READ` and `WRITE` requests, the CDB passed to the adapter from the initiator host has a read protect/write protect (`RDPROTECT`/`WRPROTECT`) field that indicates to the target whether to perform data integrity verification. It also indicates whether to transfer protection data between the initiator and the target. The adapter does not know if a target supports protection information or the type of protection with which it has been formatted. The initiator host, which has this knowledge, will always prepare a CDB with the appropriate `RDPROTECT`/`WRPROTECT` information, depending on the target format and capabilities. The request also includes information about the protection type with which the target has been formatted.

In addition, the initiator host will also provide the adapter with an operation code that tells the controller how to place the protection data for the type of I/O to perform. Each I/O is logically a two-step process. The data is transferred between the initiator host and the adapter (over the PCI bus) and between the adapter and the target (over the SAN) as shown in the following figure. The type of operation defines whether the data transfer has protection data.

Figure 2: Data Transfer between the Initiator Host and the Adapter

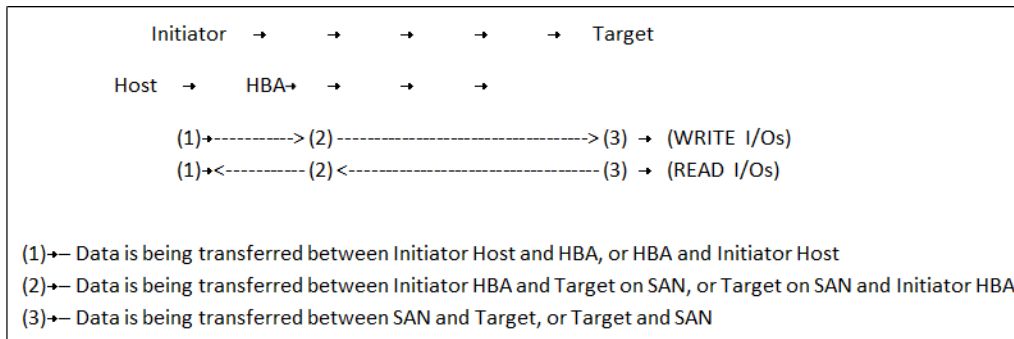

The initiator operations are listed in the following table.

Table 12: Initiator Operations

Initiator Operation	Initiator Host <-> Adapter	Adapter <-> Target	Comment
NORMAL	Unprotected	Unprotected	Used for unprotected I/O.
READ_INSERT	Protected	Unprotected	Reads the data from the target. The adapter then generates the protection data and transfers both data and protection data to the initiator host. No protection data is sent on the SAN. The adapter can insert the protection data Guard tag as a CRC or an IP checksum.
READ_PASS	Protected	Protected	Reads the data and the protection data from the target on the SAN. The adapter verifies data integrity and transfers both data and the protection data to the initiator host. The adapter can convert the protection data Guard tag from CRC to IP checksum.

Table 12: Initiator Operations (Continued)

Initiator Operation	Initiator Host <-> Adapter	Adapter <-> Target	Comment
READ_STRIP	Unprotected	Protected	Reads the data and protection data from the target. The adapter verifies data integrity, discards protection data, and transfers only the data to the initiator host. It does not send the protection data to the initiator host. Protection data is sent only on the SAN.
WRITE_INSERT	Unprotected	Protected	Transfers the data from the initiator host. The adapter then generates protection data and writes both the data and protection data to the target. Protection data is sent only on the SAN.
WRITE_PASS	Protected	Protected	Transfers the data and protection data from the initiator host to the adapter. The adapter verifies protection data and writes both data and protection data to the target on the SAN. The adapter can convert the protection data Guard tag from IP checksum to CRC.
WRITE_STRIP	Protected	Unprotected	Transfers data and protection data from the initiator host. The adapter verifies data integrity, discards protection data, and writes only the data to the target. No protection data is sent on the SAN.

B.4 lpfc Driver Module Parameters

The `lpfc` driver has two module parameters: `lpfc_prot_mask` and `lpfc_prot_guard`. Using these parameters, you can control which DIF capabilities the `lpfc` driver registers with the ESXi SCSI subsystem. This, in turn, controls which initiator operations (BlockGuard profiles) are used during I/O operations. These parameters are set up when the driver loads and cannot be changed while the driver is running.

B.4.1 lpfc_prot_mask

This parameter controls the DIF operations that the driver registers with the hypervisor. The hypervisor selects an operation to use for each I/O command that matches the adapter DIF capability. The driver indicates its capabilities by the operations that it registers with the hypervisor.

If the parameter is not passed to the driver, the default results in registering capabilities for all profiles.

The SCSI layer will typically use the bit masks listed in the following table to determine how to place the protection data associated with I/Os to the SCSI host.

Table 13: lpfc_prot_mask Protection Types

Flag	Value	Indicates	Description
<code>VMK_SCSI_TYPE1_PROT</code>	1	Adapter supports T10 DIF Type 1	Adapter-to-target Type 1 protection
<code>VMK_SCSI_DIX_TYPE0_PROT</code>	8	Adapter supports DIX Type 0	Host-to-adapter protection only
<code>VMK_SCSI_DIX_TYPE1_PROT</code>	16	Adapter supports DIX Type 1	Host-to-adapter Type 1 protection

The following table shows how protection data gets placed for each supported profile.

Table 14: Protection Data Placement for Supported Profiles

Flag	Value	BlockGuard Profile	Operation
VMK_SCSI_TYPE1_PROT	1	A1	READ_STRIP/WRITE_INSERT
VMK_SCSI_DIX_TYPE0_PROT	8	AST2	READ_INSERT/WRITE_STRIP
VMK_SCSI_DIX_TYPE1_PROT VMK_SCSI_TYPE1_PROT	17	AST1 / C1	READ_PASS/WRITE_PASS

B.4.2 lpfc_prot_guard

This parameter specifies the type of CRC that the ESXi hypervisor passes to the `lpfc` driver. The following table shows the three guard types: CRC, IP checksum, and TYPE_ALL with values of 0x1, 0x2, and 0x3 respectively.

Table 15: lpfc_prot_guard Guard Types

Flag	Value	Indicates
VMK_SCSI_GUARD_CRC	1	Adapter supports T10 DIF CRC
VMK_SCSI_GUARD_IP	2	Adapter supports both T10 DIF CRC and IP checksum
VMK_SCSI_GUARD_TYPE_ALL_VALID	3	Adapter supports both T10 DIF CRC and IP checksum

The default value for `lpfc_prot_guard` is `VMK_SCSI_GUARD_TYPE_ALL_VALID`, which results in registering capabilities for all guard types. This value defines the format for the Guard tag when the data is transferred between the host and the adapter. When data is transferred on the wire, the protection data Guard tag is always translated into a T10 DIF CRC.

The SCSI layer typically uses an IP checksum as the method for computing the protection data Guard tag because it uses less CPU overhead.

Appendix C: Using the VMID Feature on a Brocade Switch

This appendix describes the setup required for the Broadcom ECD VMID feature to work on a Brocade switch. VMID requires a VMID-supported target and initiator to work.

1. Set up the Brocade switch.
 - a. Install firmware version 8.0.1 or later on the switch.
 - b. The Broadcom ECD VMID feature is enabled by default on Brocade switches.

2. Set up the target.

Use an FC target that supports the VMID feature.

3. Set up the initiator.

Set up the driver parameters to enable VMID on your ESXi host. For example:

```
# esxcli system module parameters set -p "lpfc_max_vmid=8 lpfc_vmid_app_header=1" -m lpfc
```

`lpfc_max_vmid` is the driver parameter that indicates the number of VMID VMs supported.

- The minimum value is 4.
- The maximum value is 255.
- The default value is 8.

`lpfc_vmid_app_header` is the driver parameter that enables Brocade VMID support on ESXi.

- 0 = Disabled.
- 1 = Enabled.

4. After you have set the parameters, reboot the system for the changes to take effect.

5. Map a LUN from the FC target to a VM.

6. You can view the VMID of the VM whose LUN you mapped in [Step 5](#) using the following command:

```
/usr/lib/vmware/vmkmgmt_keyval/vmkmgmt_keyval -i vmhbaX/Emulex -k vmid -g
```

Output similar to the following is shown:

```
Key 'vmid':
lpfc VMID page: on
ID00 READs:000000000001c611 WRITEs:0000000000000000
UUID:
35322065312062302036662038632035662036362036612d3739206333206139206636203332203464203139203230
String (52 e1 b0 6f 8c 5f 66 6a-79 c3 a9 f6 32 4d 19 20)
Application id: 209
Last access time: 2016-10-25T10:58:05
Compressed: 52e1b06f8c5f666a79c3a9f6324d1920
```

7. On the Brocade switch, you can run the following command to verify the list of VMIDs:

```
> /fabos/cliexec/appserver --show -all
```

Output similar to the following is shown:

```
-----  
Displaying results for Fabric  
-----
```

```
N_Port ID : 7e1200
```

```
Entity Name :
```

```
Entity ID (ASCII) : 52 e1 b0 6f 8c 5f 66 6a-79 c3 a9 f6 32 4d 19 20
```

```
Entity ID (Hex) :
```

```
0x35322065312062302036662038632035662036362036612d37392063332061392066362033322034642031392032300  
0
```

```
Application ID : 0x00000209h (521)
```

```
-----  
Application Server displays 1 entries
```

Appendix D: Using the VMID Feature on a Cisco Switch

This appendix describes the setup required for the Broadcom ECD VMID feature to work on a Cisco switch. VMID requires a VMID-supported target and initiator to work.

1. Set up the Cisco switch.
 - a. Install firmware version 8.2 or later on the switch.
 - b. The Broadcom ECD VMID feature is not enabled by default on Cisco switches. Run the following command once to configure VMIS globally on your switch:

```
switch(config)# feature vmis
```

2. Set up the target.

Use an FC target that supports the VMID feature.

3. Set up the initiator.

Set up the driver parameters to enable VMID on your ESXi host.

For example:

```
# esxcli system module parameters set -p "lpfc_max_vmid=8 lpfc_vmid_priority_tagging=1" -m lpfc
```

`lpfc_max_vmid` is the driver parameter that indicates the number of VMID VMs supported.

- The minimum value is 4.
- The maximum value is 255.
- The default value is 8.

`lpfc_vmid_priority_tagging` is the driver parameter that enables Cisco VMID support on ESXi. The possible values are:

- 0 = Disabled (default).
- 1 = Priority tagging for targets that support it in their `PLOGI LS_ACC` response.
- 2 = Priority tagging for all targets, whether they support `PLOGI LS_ACC`.

4. After you have set the parameters, reboot the system for the changes to take effect.
5. Map a LUN from the FC target to a VM.

6. You can view the VMID of the VM whose LUN you mapped in [Step 5](#) using the following command:

```
/usr/lib/vmware/vmkmgmt_keyval/vmkmgmt_keyval -i vmhbaX/Emulex -k vmid -g
```

Output similar to the following is shown:

```
lpfc VMID page: on
VMID priority ranges:
    [x1 - xff], qos: x0
VEM ID: 10:00:00:90:fa:c7:aa:b8:20:00:00:90:fa:c7:aa:b8
ID00 READs:000000000005e853 WRITEs:000000000005e879
UUID:
35302030372032352037332033382036652032392036612d3063203237203466203361203463203363203838206561
String (50 07 25 73 38 6e 29 6a-0c 27 4f 3a 4c 3c 88 ea)
CS_CTL VMID: x1
Last access time: 2018-05-14T09:49:42
Compressed: 50072573386e296a0c274f3a4c3c88ea
```

7. On the Cisco switch, you can run the following command to get the mapping between the FCID and the WWPN:

```
(config-if)# show flogi database details
```

Output similar to the following is shown:

```
-----
INTERFACE          VSAN    FCID          PORT NAME          NODE NAME          FLAGS
-----
fc3/4              102    0x010025     10:00:00:00:c9:d1:a4:ec 20:00:00:00:c9:d1:a4:ec PM
fc3/9              102    0x010045     10:00:e0:07:1b:ce:58:62 20:00:e0:07:1b:ce:58:62 P
-----
```

Total number of flogi = 2.

FLAGS:

A area FCID allocation

L loop device

V FDISC

D the wwn matches the default OUI list

O the wwn matches the configured OUI list

P allocation was done based on the persistency table

M indicates a VMID capable FCID

On the Cisco switch, you can run the following command to get the mapping between, the FCID and the VMID:

```
(config-if)# show vmis database
```

An output similar to the following is shown:

Total 1 entries

```
-----
INTERFACE          VSAN    FCID          LOCAL VEID          GLOBAL VEID
-----
fc3/4              102    0x010025     0x01                50072573-386e-296a-0c27-4f3a4c3c88ea
-----
```

Appendix E: NPIV Configuration

This appendix describes how to configure NPIV on an ESXi host.

Most switches come with NPIV support, and the feature is enabled by default.

To enable NPIV on an ESXi host using the VMware vCenter Server, perform the following steps:

1. Make sure a VM exists with at least one Mapped Raw LUN (RDM) assigned.

Select **Edit Settings > Virtual Hardware**. Click **New Hard disk**. The existing RDMs are displayed; see [Figure 3](#).

Figure 3: VM With a Mapped Raw LUN

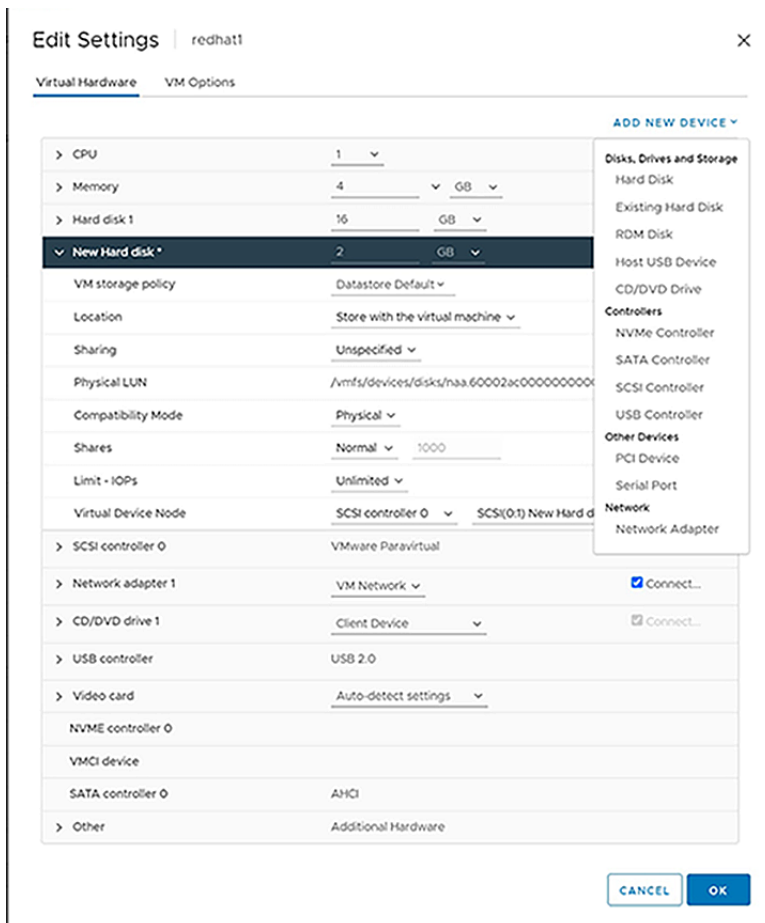

2. Assign NPIV ports to the VM.

To assign NPIV ports to the VM, perform the following steps:

- a. On the VM, select **Edit Settings > VM Options**. See [Figure 4](#).
- b. Select **Fibre Channel NPIV**.
- c. Make sure the **Temporarily Disable NPIV for this virtual machine** box is unchecked.
- d. Select **Generate new WWNs**.
- e. Choose the number of WWNNs and number of WWPNS for the NPIV port.

NOTE: You must have at least one WWNN and you can have one or many WWPNs.
For every physical port that exists in the ESXi host, one NPIV port is created.

Figure 4: Assign NPIV Ports

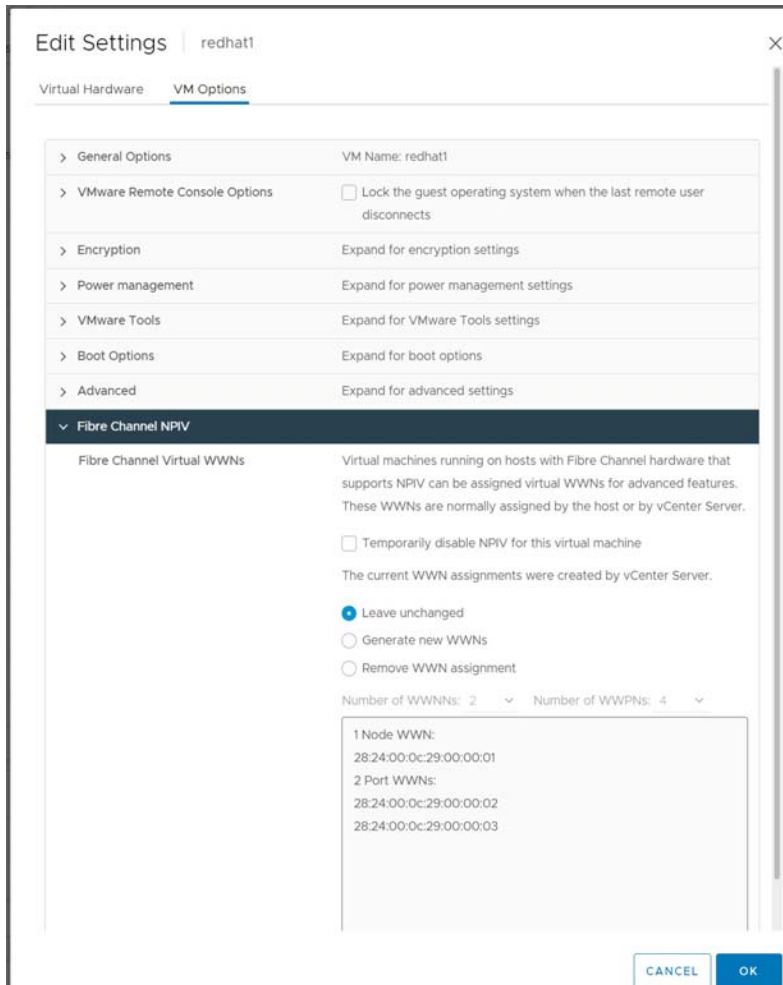

- f. Make a note of the newly assigned WWNNs and WWPns (NPIV ports).
3. Manually configure the same WWNNs and WWPns in the switch zone.
4. Configure the same WWNNs and WWPns in the array management software.
5. Power on the VM. The NPIV ports are created on power-on.

NOTE: Repeat this procedure for each VM, and power on the VM.

To verify if the NPIV ports are created, perform the following steps:

1. On the switch, check the NameServer for the configured WWNNs and WWPns.
2. On the ESXi host, run the following command to view the NPIV ports created:

```
/usr/lib/vmware/vmkmgmt_keyval/vmkmgmt_keyval -d
```

The created vPorts are displayed.

An output similar to the following is shown:

```
Dumping all key-value instance names:
Key Value Instance:  vmhba67/Emulex
Key Value Instance:  vmhba66/Emulex
Key Value Instance:  vmhba5/Emulex
Key Value Instance:  vmhba4/Emulex
Key Value Instance:  vmhba72/Emulex
Key Value Instance:  vmhba2/Emulex
Key Value Instance:  vmhba1/vmw_ahci
Key Value Instance:  vmhba0/vmw_ahci
Key Value Instance:  lsi_mr3-54cd98f0a033bc00/LSI Incorporation
```

NOTE: If no NPIV ports are shown, it indicates that you might have not configured them correctly. Check the `vmkernel.log` file for errors, and contact Broadcom Technical support for assistance.

3. On the ESXi host, run the following command to view an NPIV port configuration:

```
/usr/lib/vmware/vmkmgmt_keyval/vmkmgmt_keyval -i vmhba66/Emulex -k adapter -g
```

Information pertaining to the NPIV port is displayed.

An output similar to the following is shown:

```
Key 'adapter':
lpfc Adapter Page

Emulex LightPulse FC SCSI 12.8.329.0
Emulex LPe35004-M2 4-Port 32Gb Fibre Channel Adapter on PCI bus 0000:86 device 00 fn 3 port 3 Logical
Link Speed: 32000 Mbps

BoardNum:          3
FW Version:        12.8.326.1
HW Version:        0000000d
ROM Version:       12.8.326.1
SerialNum:         FP01896477
PCI ID:            10df f400 10df f405

SLI Rev: 4
MQ: Enabled with 2 queues (2)
NPIV Supported: VPIs max 255 VPIs used 1
RPIs max 3072 RPIs used 17 IOCBs inuse 0 IOCB max 15 txq cnt 0 txq max 0 txcmplq 0
XRIs max 3072 FCP 990 Base 9217
FCP SGEs max 67 DMA buf size 4080

Queue Depth
LUN                64
HBA FCP            2822

ABORTs FCP 0 ELS 0: Total 0 - IssueErr 0 Cmpl 0
PCI read error: 0 retry attempts: 0

Supported Speed: 8G 16G 32G
Link Up - Ready:
EDTOV 2000 ms RATOV 10 sec
PortID 0x320f01
Fabric
Current speed 32G

WWPN 28:24:00:0c:29:00:00:02 WWNN 28:24:00:0c:29:00:00:01

Mode: Online
```

Interrupt Type: MSIX
BlockGuard Disabled
External DIF Enabled

BBCredit Recovery Supported
BBSCN default:8 min:1 max:15

```
[root@dhcp-10-123-183-217:~] /usr/lib/vmware/vmkmgmt_keyval/vmkmgmt_keyval -i vmhba66/Emulex -k  
lun -g
```

Key 'lun':

lpfc Lun Path Stats Page:

```
LUN[0:3] WWNN 2f:f7:00:02:ac:01:90:40 WWPN 21:01:00:02:ac:01:90:40 path is ok  
qdepth 64 fcperr 0001 abts issue 000000 cnt 000000 lun_rst 0000 tx_cnt 00000008  
partial_sns_cnt 0000
```

```
LUN[1:3] WWNN 2f:f7:00:02:ac:01:90:40 WWPN 20:01:00:02:ac:01:90:40 path is ok  
qdepth 64 fcperr 0001 abts issue 000000 cnt 000000 lun_rst 0000 tx_cnt 00000008  
partial_sns_cnt 0000
```

Appendix F: License Notices

F.1 OpenSSL Notice

This is a copy of the current LICENSE file inside the CVS repository.

LICENSE ISSUES

=====

The OpenSSL toolkit stays under a dual license, i.e. both the conditions of the OpenSSL License and the original SSLeay license apply to the toolkit. See below for the actual license texts. Actually both licenses are BSD-style Open Source licenses. In case of any license issues related to OpenSSL please contact openssl-core@openssl.org.

OpenSSL License

```

/* =====
 * Copyright (c) 1998-2011 The OpenSSL Project. All rights reserved.
 *
 * Redistribution and use in source and binary forms, with or without
 * modification, are permitted provided that the following conditions
 * are met:
 *
 * 1. Redistributions of source code must retain the above copyright
 *    notice, this list of conditions and the following disclaimer.
 *
 * 2. Redistributions in binary form must reproduce the above copyright
 *    notice, this list of conditions and the following disclaimer in
 *    the documentation and/or other materials provided with the
 *    distribution.
 *
 * 3. All advertising materials mentioning features or use of this
 *    software must display the following acknowledgment:
 *    "This product includes software developed by the OpenSSL Project
 *    for use in the OpenSSL Toolkit. (http://www.openssl.org/)"
 *
 * 4. The names "OpenSSL Toolkit" and "OpenSSL Project" must not be used to
 *    endorse or promote products derived from this software without
 *    prior written permission. For written permission, please contact
 *    openssl-core@openssl.org.
 *
 * 5. Products derived from this software may not be called "OpenSSL"
 *    nor may "OpenSSL" appear in their names without prior written
 *    permission of the OpenSSL Project.
 *
 * 6. Redistributions of any form whatsoever must retain the following
 *    acknowledgment:
 *    "This product includes software developed by the OpenSSL Project
 *    for use in the OpenSSL Toolkit (http://www.openssl.org/)"
 *
 * THIS SOFTWARE IS PROVIDED BY THE OpenSSL PROJECT ``AS IS'' AND ANY
 * EXPRESSED OR IMPLIED WARRANTIES, INCLUDING, BUT NOT LIMITED TO, THE
 * IMPLIED WARRANTIES OF MERCHANTABILITY AND FITNESS FOR A PARTICULAR
 * PURPOSE ARE DISCLAIMED. IN NO EVENT SHALL THE OpenSSL PROJECT OR
 * ITS CONTRIBUTORS BE LIABLE FOR ANY DIRECT, INDIRECT, INCIDENTAL,
 * SPECIAL, EXEMPLARY, OR CONSEQUENTIAL DAMAGES (INCLUDING, BUT
 * NOT LIMITED TO, PROCUREMENT OF SUBSTITUTE GOODS OR SERVICES;
 * LOSS OF USE, DATA, OR PROFITS; OR BUSINESS INTERRUPTION)
 * HOWEVER CAUSED AND ON ANY THEORY OF LIABILITY, WHETHER IN CONTRACT,
 * STRICT LIABILITY, OR TORT (INCLUDING NEGLIGENCE OR OTHERWISE)
 * ARISING IN ANY WAY OUT OF THE USE OF THIS SOFTWARE, EVEN IF ADVISED
 * OF THE POSSIBILITY OF SUCH DAMAGE.
 * =====
 *
 * This product includes cryptographic software written by Eric Young
 * (eay@cryptsoft.com). This product includes software written by Tim
 * Hudson (tjh@cryptsoft.com).
 *
 */
Original SSLeay License
-----
/* Copyright (C) 1995-1998 Eric Young (eay@cryptsoft.com)

```

```
* All rights reserved.
*
* This package is an SSL implementation written
* by Eric Young (eay@cryptsoft.com).
* The implementation was written so as to conform with Netscapes SSL.
*
* This library is free for commercial and non-commercial use as long as
* the following conditions are aheared to. The following conditions
* apply to all code found in this distribution, be it the RC4, RSA,
* lhash, DES, etc., code; not just the SSL code. The SSL documentation
* included with this distribution is covered by the same copyright terms
* except that the holder is Tim Hudson (tjh@cryptsoft.com).
*
* Copyright remains Eric Young's, and as such any Copyright notices in
* the code are not to be removed.
* If this package is used in a product, Eric Young should be given attribution
* as the author of the parts of the library used.
* This can be in the form of a textual message at program startup or
* in documentation (online or textual) provided with the package.
*
* Redistribution and use in source and binary forms, with or without
* modification, are permitted provided that the following conditions
* are met:
* 1. Redistributions of source code must retain the copyright
* notice, this list of conditions and the following disclaimer.
* 2. Redistributions in binary form must reproduce the above copyright
* notice, this list of conditions and the following disclaimer in the
* documentation and/or other materials provided with the distribution.
* 3. All advertising materials mentioning features or use of this software
* must display the following acknowledgement:
* "This product includes cryptographic software written by
* Eric Young (eay@cryptsoft.com)"
* The word 'cryptographic' can be left out if the rouines from the library
* being used are not cryptographic related :-).
* 4. If you include any Windows specific code (or a derivative thereof) from
* the apps directory (application code) you must include an acknowledgement:
* "This product includes software written by Tim Hudson (tjh@cryptsoft.com)"
*
* THIS SOFTWARE IS PROVIDED BY ERIC YOUNG ``AS IS'' AND
* ANY EXPRESS OR IMPLIED WARRANTIES, INCLUDING, BUT NOT LIMITED TO, THE
* IMPLIED WARRANTIES OF MERCHANTABILITY AND FITNESS FOR A PARTICULAR PURPOSE
* ARE DISCLAIMED. IN NO EVENT SHALL THE AUTHOR OR CONTRIBUTORS BE LIABLE
* FOR ANY DIRECT, INDIRECT, INCIDENTAL, SPECIAL, EXEMPLARY, OR CONSEQUENTIAL
* DAMAGES (INCLUDING, BUT NOT LIMITED TO, PROCUREMENT OF SUBSTITUTE GOODS
* OR SERVICES; LOSS OF USE, DATA, OR PROFITS; OR BUSINESS INTERRUPTION)
* HOWEVER CAUSED AND ON ANY THEORY OF LIABILITY, WHETHER IN CONTRACT, STRICT
* LIABILITY, OR TORT (INCLUDING NEGLIGENCE OR OTHERWISE) ARISING IN ANY WAY
* OUT OF THE USE OF THIS SOFTWARE, EVEN IF ADVISED OF THE POSSIBILITY OF
* SUCH DAMAGE.
*
* The licence and distribution terms for any publically available version or
* derivative of this code cannot be changed. i.e. this code cannot simply be
* copied and put under another distribution licence
* [including the GNU Public Licence.]
*/
```

