

HLMP-Q700, HLMP-Q700-000xx

Infrared Subminiature LED Lamps

Description

The Broadcom[®] HLMP-Q700/Q700-000xx are made by encapsulating an AlGaAs chip on axial leadframe to form molded epoxy subminiature lamps.

This 2-mm dome emitter is rolled out in straight, gull-wing, and Z-bend lead options for ease of industry standard automatic machine assembly. Its 850-nm peak wavelength makes it ideal for applications such as smart meters, light curtains in industrial automation, particle sensors, remote controls in home application, and so on.

Features

- 2-mm untinted, non-diffused dome
- Low power consumption
- Easy assembly
- 500 units (bulk packaging) for straight lead option, 1500 units per reel for gull-wing and Z-bend lead options
- Moisture Sensitivity Level: Level 3
- RoHS compliant

Applications

- Smart meter
- Light curtains
- Remote control
- Particle sensor

Figure 1: Package Drawing

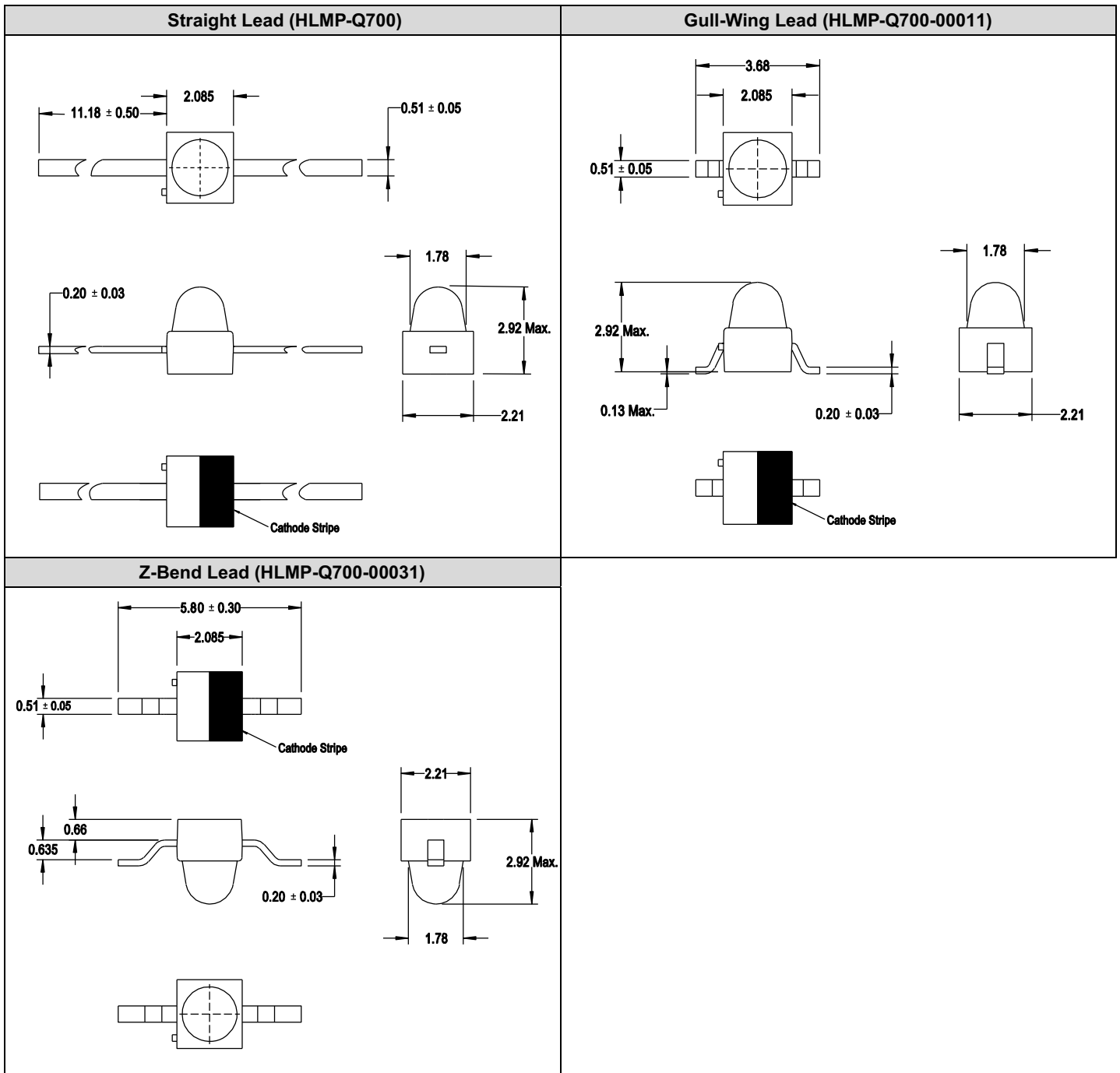

NOTE:

1. All dimensions are in millimeters (mm).
2. Tolerance is ±0.13 mm unless otherwise specified.
3. Protruding support tab is connected to the cathode lead.
4. Lead finishing is tin (Sn).

Device Selection Guide ($T_J = 25^\circ\text{C}$, $I_F = 50\text{ mA}$)

Part Number	Die Type	Radiant Intensity, I_e (mW/sr) ^{a,b,c}			Viewing Angle, $2\theta_{1/2}$ ($^\circ$) ^d
		Min.	Typ.	Max.	Typ.
HLMP-Q700/ HLMP-Q700-000xx	AlGaAs	45.0	70.0	112.5	18

- The radiant intensity, I_e is measured at the mechanical axis of the package with a single current pulse condition ($t_p = 20\text{ ms}$).
- The optical axis is closely aligned with the mechanical axis of the package.
- Tolerance is $\pm 15\%$.
- $\theta_{1/2}$ is the off-axis angle where the radiant intensity is half of the peak intensity.

Absolute Maximum Ratings

Parameters	Rating	Unit
DC Forward Current ^a	100	mA
Peak Forward Current ^{b,c}	350	mA
Power Dissipation	170	mW
LED Junction Temperature	100	$^\circ\text{C}$
Operating Temperature Range	-40 to +85	$^\circ\text{C}$
Storage Temperature Range	-40 to +100	$^\circ\text{C}$

- Derate linearly as shown in [Figure 8](#).
- Duty factor = 1%, $t_p = 100\ \mu\text{s}$.
- Solder point temperature, $T_S = 25^\circ\text{C}$.

Optical and Electrical Characteristics ($T_J = 25^\circ\text{C}$)

Parameter	Symbol	Min.	Typ.	Max.	Unit	Test Conditions
Radiant Flux ^a	ϕ_e	—	26	—	mW	$I_F = 50\text{ mA}$, $t_p = 20\text{ ms}$
Peak Wavelength	λ_{PEAK}	835	850	870	nm	$I_F = 50\text{ mA}$, $t_p = 20\text{ ms}$
Temperature Coefficient of Radiant Intensity	TK_{I_e}	—	-0.12	—	%/°C	$I_F = 50\text{ mA}$
		—	-0.15	—	%/°C	$I_F = 100\text{ mA}$
Temperature Coefficient of λ_p	TK_{λ_p}	—	0.20	—	nm/°C	$I_F = 50\text{ mA}$
Spectral Line Half-Width	$\Delta\lambda_{1/2}$	—	24	—	nm	$I_F = 50\text{ mA}$, $t_p = 20\text{ ms}$
Junction Capacitance	C_J	—	26	—	pF	$V_R = 0\text{V}$, $f = 1\text{ MHz}$
Forward Voltage ^b	V_F	1.30	1.54	1.70	V	$I_F = 50\text{ mA}$
		—	1.64	—	V	$I_F = 100\text{ mA}$
Temperature Coefficient of V_F	TK_{V_F}	—	-1.33	—	mV/°C	$I_F = 50\text{ mA}$
		—	-1.64	—	mV/°C	$I_F = 100\text{ mA}$
Reverse Voltage ^c	V_R	5	—	—	V	$I_R = 10\text{ }\mu\text{A}$
Rise Time	t_r	—	15	—	ns	$I_F = 50\text{ mA}$
Fall Time	t_f	—	15	—	ns	$I_F = 50\text{ mA}$
Thermal Resistance	$R\theta_{J-S}$	—	120	—	°C/W	LED junction to solder point

a. The radiant flux, ϕ_e , is the total flux output as measured with an integrating sphere at a single current pulse condition ($t_p = 20\text{ ms}$).

b. Forward voltage tolerance is $\pm 0.1\text{V}$.

c. Indicates product final test condition. Long term reverse bias is not recommended.

Part Numbering System for Gull-Wing Lead and Z-Bend Lead

H L M P - Q 7 0 0 - 0 0 0 $\boxed{x_1}$ $\boxed{x_2}$

Code	Description	Option	
$x_1 x_2$	Packing Option	11	Gull-wing lead, 7-inch tape and reel, 1500 pieces
		31	Z-bend lead, 7-inch tape and reel, 1500 pieces

Figure 2: Spectral Power Distribution

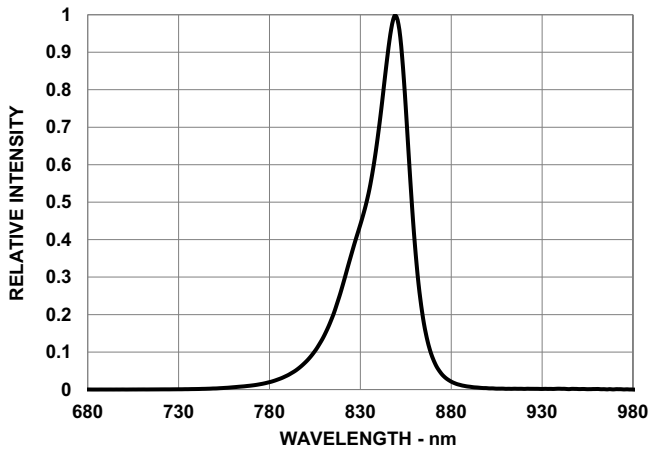

Figure 3: Forward Current vs. Forward Voltage

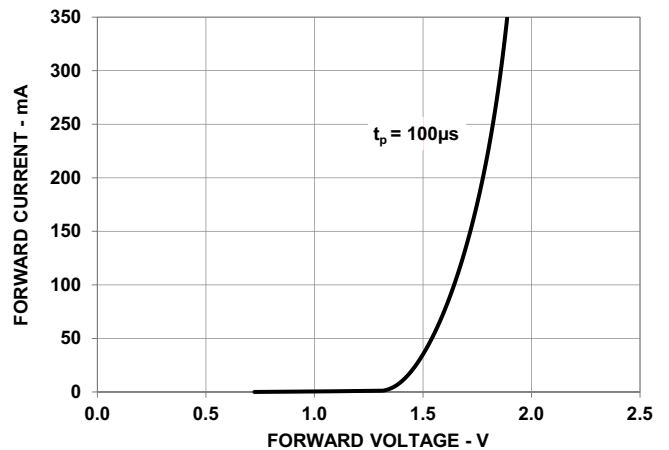

Figure 4: Relative Radiant Intensity vs. Mono Pulse Current

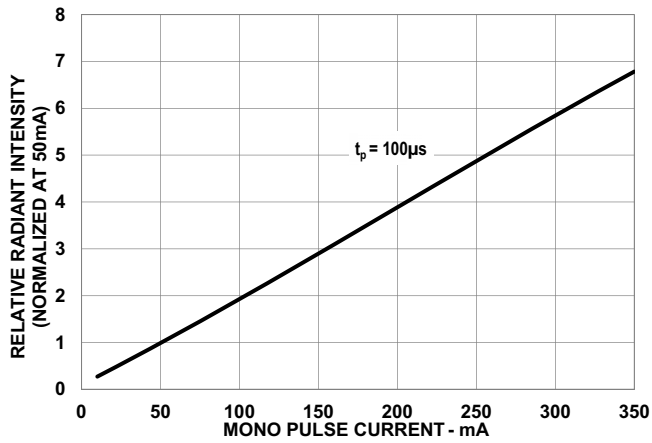

Figure 5: Radiation Pattern

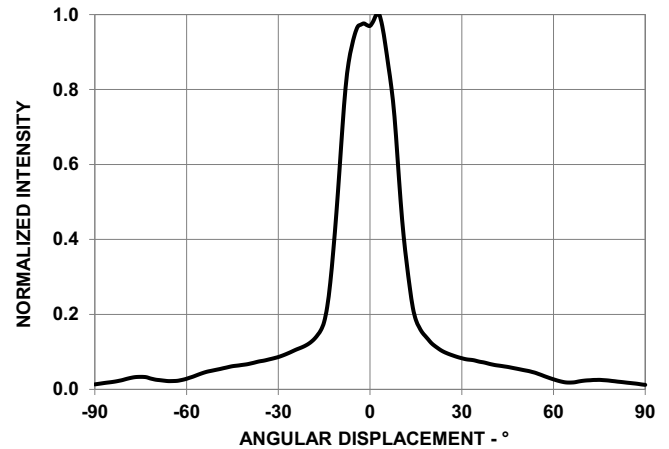

Figure 6: Relative Radiant Intensity vs. Junction Temperature

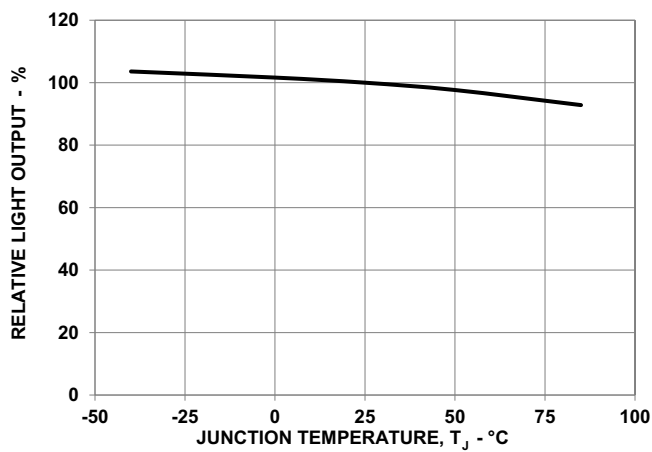

Figure 7: Forward Voltage Shift vs. Junction Temperature

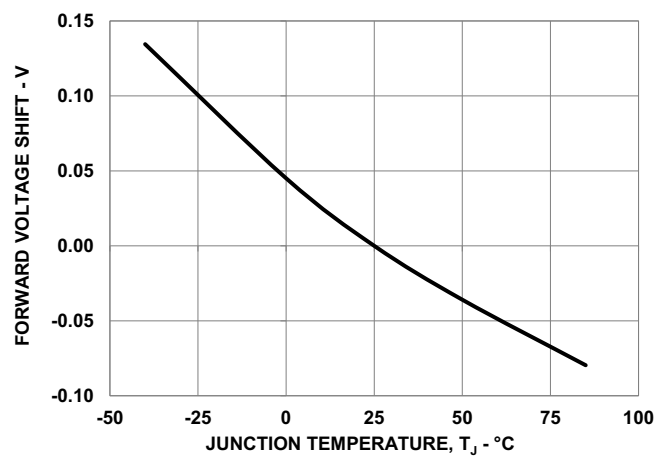

Figure 8: Maximum Forward Current vs. Ambient Temperature

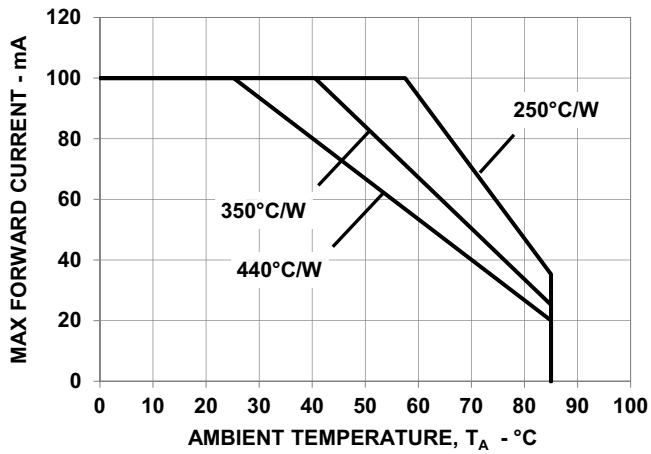

Figure 9: Recommended Soldering Land Pattern for Gull-Wing Lead

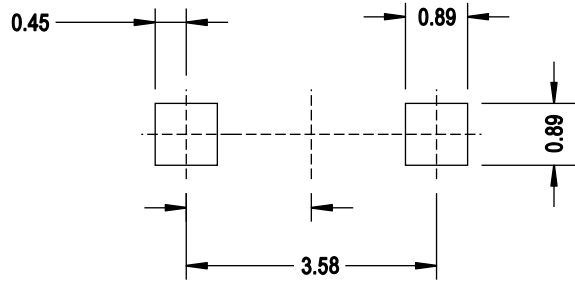

Figure 10: Recommended Soldering Land Pattern for Z-Bend Lead

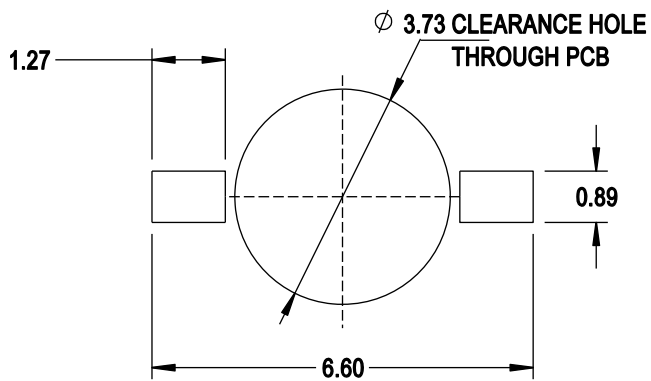
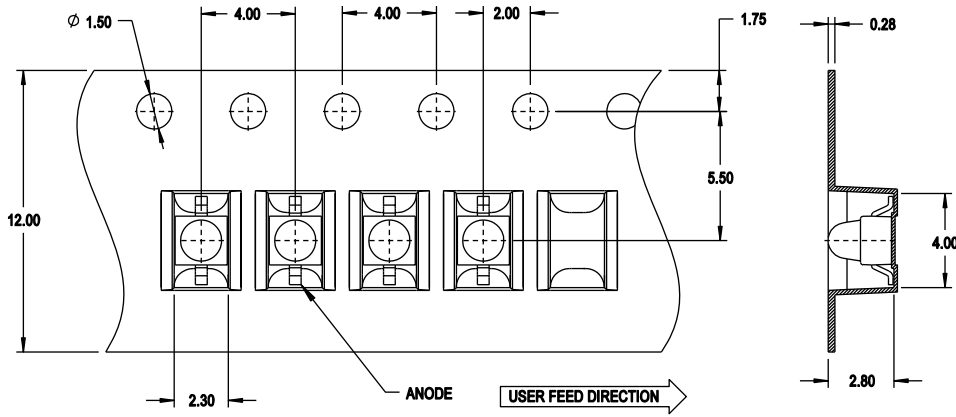
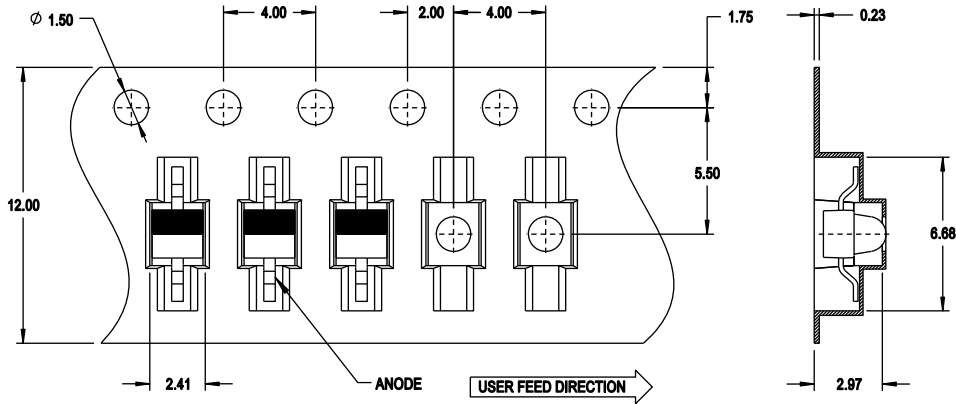

Figure 11: Carrier Tape Dimensions for Gull-Wing Lead



NOTE: All dimensions are in millimeters (mm).

Figure 12: Carrier Tape Dimensions for Z-Bend Lead



NOTE: All dimensions are in millimeters (mm).

Figure 13: Reel Dimensions (7-inch Tape and Reel)

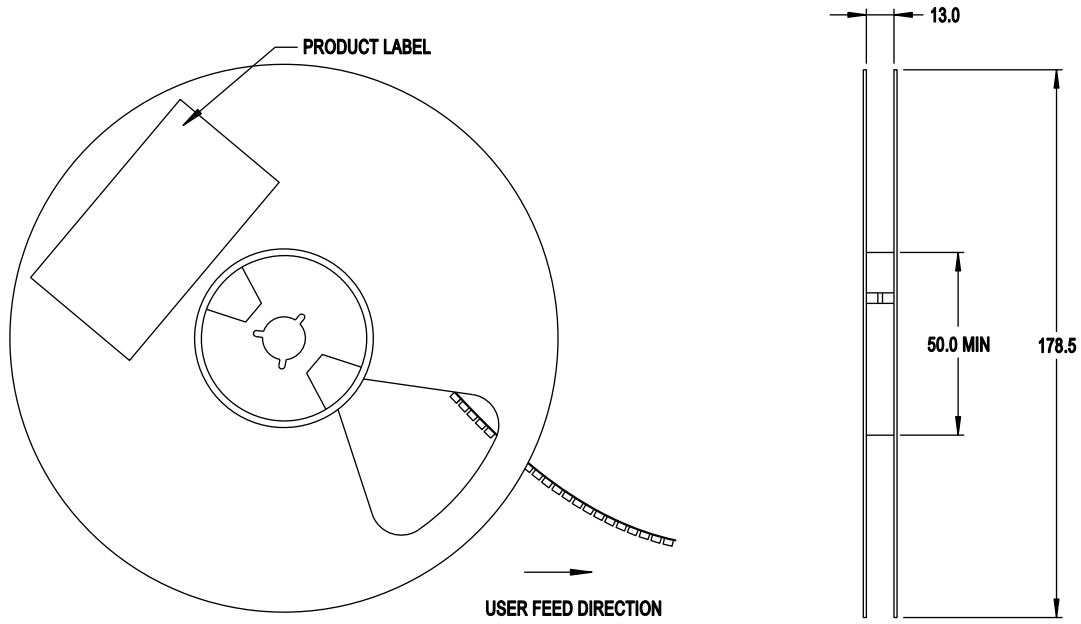

NOTE: All dimensions are in millimeters (mm).

Precautionary Notes

Soldering and Handling Precautions

- Do not perform reflow soldering more than twice. Observe necessary precautions of handling moisture-sensitive device as stated in the following section.
- Do not apply any pressure or force on the LED during reflow and after reflow when it is still hot.
- Use reflow soldering to solder the LED. Use hand soldering only for rework if unavoidable, but it must be strictly controlled to the following conditions:
 - Soldering iron tip temperature = 310°C maximum.
 - Soldering duration = 2 seconds maximum.
 - Number of cycles = 1 only.
 - Power of soldering iron = 50W maximum.
- Do not touch the LED package body with the soldering iron except for the soldering terminals because it can cause damage to the LED.
- Confirm beforehand whether the functionality and performance of the LED is affected by soldering with hand soldering.

Figure 14: Recommended Lead-Free Reflow Soldering Profile

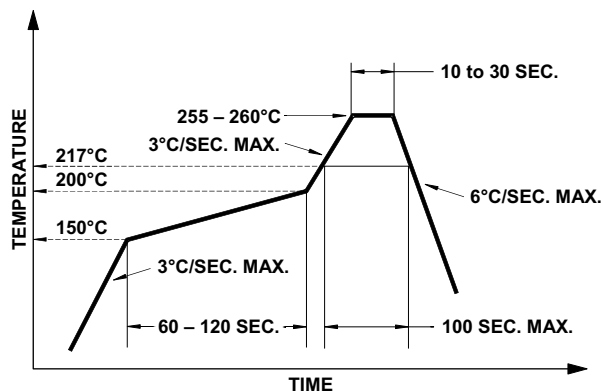

Handling Precautions

The product has a Moisture Sensitive Level 3 rating per JEDEC J-STD-020. Refer to Broadcom Application Note AN5305, *Handling of Moisture Sensitive Surface Mount Devices* for additional details and a review of proper handling procedures.

Before use:

- An unopened moisture barrier bag (MBB) can be stored at <40°C/90% RH for 12 months. If the actual shelf life has exceeded 12 months and the Humidity Indicator Card (HIC) indicates that baking is not required, then it is safe to reflow the LEDs per the original MSL rating.
- Do not open the MBB prior to assembly (for example, for IQC). If unavoidable, MBB must be properly resealed with fresh desiccant and HIC. The exposed duration must be taken in as floor life.

Control after opening the MBB:

- Read the HIC immediately upon opening of MBB.
- Keep the LEDs at <30°/60%RH at all times, and complete all high temperature-related processes, including soldering, curing or rework within 168 hours.

Control for unfinished reel:

- Store unused LEDs in a sealed MBB with desiccant or a desiccator at <5% RH.

Control of assembled boards:

- If the PCB soldered with the LEDs is to be subjected to other high-temperature processes, store the PCB in a sealed MBB with desiccant or desiccator at <5% RH to ensure that all LEDs have not exceeded their floor life of 168 hours.

Baking is required if:

- The HIC indicator indicates a change in color for 10% and 5%, as stated on the HIC.
- The LEDs are exposed to conditions of >30°C/60% RH at any time.
- The LED's floor life exceeded 168 hours.

The recommended baking condition is: 60 ±5°C for 20 hours.

Baking can only be done once.

Application Precautions

- The drive current of the LED must not exceed the maximum allowable limit across temperature as stated in the data sheet. Constant current driving is recommended to ensure consistent performance.
- Circuit design must cater to the whole range of forward voltage (V_F) of the LEDs to ensure the intended drive current can always be achieved.
- The LED exhibits slightly different characteristics at different drive currents, which can result in a larger variation of performance (such as intensity, wavelength, and forward voltage). Set the application current as close as possible to the test current to minimize these variations.
- The LED is not intended for reverse bias. Use other appropriate components for such purposes. When driving the LED in matrix form, ensure that the reverse bias voltage does not exceed the allowable limit of the LED.
- Avoid rapid change in ambient temperatures, especially in high-humidity environments, because they cause condensation on the LED.
- If the LED is intended to be used in a harsh or an outdoor environment, protect the LED against damages caused by rain water, water, dust, oil, corrosive gases, external mechanical stresses, and so on.

Eye Safety Precautions

LEDs can pose optical hazards when in operation. Do not look directly at operating LEDs because it might be harmful to the eyes. For safety reasons, use appropriate shielding or personal protective equipment.

Disclaimer

Broadcom's products and software are not specifically designed, manufactured, or authorized for sale as parts, components, or assemblies for the planning, construction, maintenance, or direct operation of a nuclear facility or for use in medical devices or applications. The customer is solely responsible, and waives all rights to make claims against Broadcom or its suppliers, for all loss, damage, expense, or liability in connection with such use.

Copyright © 2023 Broadcom. All Rights Reserved. The term "Broadcom" refers to Broadcom Inc. and/or its subsidiaries. For more information, go to www.broadcom.com. All trademarks, trade names, service marks, and logos referenced herein belong to their respective companies.

Broadcom reserves the right to make changes without further notice to any products or data herein to improve reliability, function, or design. Information furnished by Broadcom is believed to be accurate and reliable. However, Broadcom does not assume any liability arising out of the application or use of this information, nor the application or use of any product or circuit described herein, neither does it convey any license under its patent rights nor the rights of others.

