

# HDSP-390x Series, HDSP-420x Series, HDSP-860x Series, HDSP-N15x Series 20-mm (0.8-in.) Seven-Segment Displays

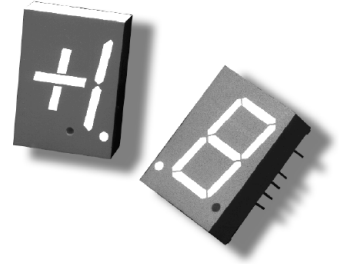

---

## Description

The Broadcom<sup>®</sup> 20-mm (0.8-in.) LED seven-segment displays are designed for viewing distances up to 10m (33 ft). These devices use an industry-standard size package and pinout. All devices are available as either common anode or common cathode.

## Applications

These displays are ideal for most applications. Pin-for-pin equivalent displays are also available in a low-current design. The low-current displays are ideal for portable applications. For additional information, see the data sheet for low-current seven-segment displays.

## Features

- Industry-standard size
- Industry-standard pinout
  - 15.24-mm (0.6-in.) DIP leads on 2.54-mm (0.1-in.) centers
- Choice of colors
  - AlInGaP deep red, AlInGaP red, AlInGaP yellow, and AlInGaP green
- Excellent appearance
  - Evenly lighted segments
  - Mitered corners on segments
  - Gray package gives optimum contrast
  - $\pm 50^\circ$  viewing angle
- Design flexibility
  - Common anode or common cathode
  - Left-hand and right-hand decimal points
- Categorized for luminous intensity
  - Yellow and green categorized for color
  - Use of like categories yields a uniform display

# Package Drawing

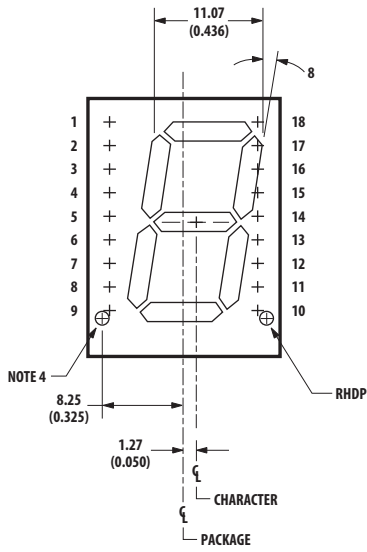

FRONT VIEW A, B

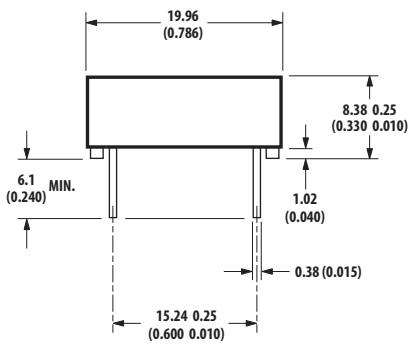

END VIEW

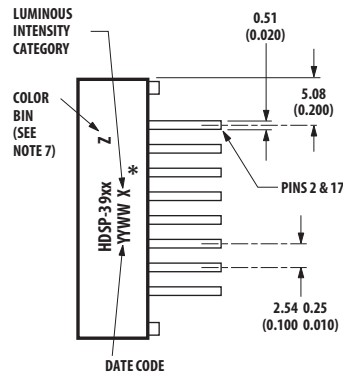

SIDE VIEW

\* THE SIDE VIEW OF PACKAGE INDICATES COUNTRY OF ORIGIN.

FUNCTION		
PIN	A	B
1	NO PIN	NO PIN
2	CATHODE a	ANODE a
3	CATHODE f	ANODE f
4	ANODE <sup>[3]</sup>	CATHODE <sup>[6]</sup>
5	CATHODE e	ANODE e
6	ANODE <sup>[3]</sup>	CATHODE <sup>[6]</sup>
7	NO CONNec.	NO CONNec.
8	NO PIN	NO PIN
9	NO PIN	NO PIN
10	CATHODE dp	ANODE dp
11	CATHODE d	ANODE d
12	ANODE <sup>[3]</sup>	CATHODE <sup>[6]</sup>
13	CATHODE c	ANODE c
14	CATHODE g	ANODE g
15	CATHODE b	ANODE b
16	NO PIN	NO PIN
17	ANODE <sup>[3]</sup>	CATHODE <sup>[6]</sup>
18	NO PIN	NO PIN

- NOTES:
1. DIMENSIONS IN MILLIMETERS AND (INCHES).
  2. ALL UNTOLERANCED DIMENSIONS ARE FOR REFERENCE ONLY.
  3. REDUNDANT ANODES.
  4. UNUSED dp POSITION.
  5. SEE INTERNAL CIRCUIT DIAGRAM.
  6. REDUNDANT CATHODES.
  7. FOR HDSP-420x/-860x SERIES PRODUCT ONLY.

## Internal Circuit Diagram

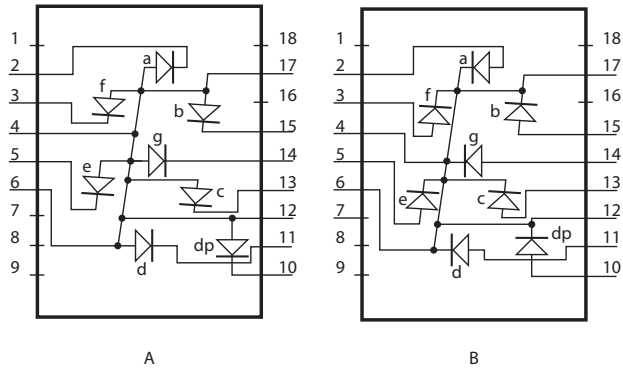

## Device Selection Guide

AllInGaP Deep Red	AllInGaP Red	AllInGaP Yellow	AllInGaP Green	Description	Package Drawing
HDSP-N151	HDSP-3901	HDSP-4201	HDSP-8601	Common Anode Right-Hand Decimal	A
HDSP-N153	HDSP-3903	HDSP-4203	HDSP-8603	Common Cathode Right-Hand Decimal	B

## Absolute Maximum Ratings

Description	Deep Red HDSP-N15x Series	Red HDSP-390x Series	Yellow HDSP-420x Series	Green HDSP-860x Series	Units
Power Dissipation per Segment or DP	100	100	100	75	mW
Peak Forward Current per Segment or DP <sup>a</sup>	90	90	60	90	mA
DC Forward Current per Segment or DP <sup>b</sup>	40	40	40	30	mA
Operating Temperature Range	-20 to +100	-40 to +100			°C
Storage Temperature Range	-55 to +100				°C
Reverse Voltage per Segment or DP <sup>c</sup>	3.0				V
Wave Soldering Temperature for 3 Seconds (1.60 mm [0.063 in.] below body)	250				°C

- Duty factor = 10%, frequency = 1 kHz,  $T_A = 25^\circ\text{C}$ .
- Derate linearly as shown in [Figure 4](#) (deep red), [Figure 8](#) (red), [Figure 16](#) (green), and [Figure 16](#) (yellow).
- Reverse voltage is for LED testing purposes and is not recommended to be used as an application condition.

## Electrical/Optical Characteristics at $T_A = 25^\circ\text{C}$

Parameter	Symbol	Min.	Typ.	Max.	Units	Test Conditions
<b>Deep Red, Device Series HDSP-N15x</b>						
Luminous Intensity/Segment (Digital Average) <sup>a, b</sup>	$I_V$	6.0	21.0	—	mcd	$I_F = 20\text{ mA}$
Forward Voltage/Segment or DP <sup>c</sup>	$V_F$	—	2.1	2.5	V	$I_F = 20\text{ mA}$
Peak Wavelength	$\lambda_p$	—	656	—	nm	—
Dominant Wavelength <sup>d</sup>	$\lambda_d$	—	639	—	nm	—
Reverse Voltage/Segment or DP <sup>e</sup>	$V_R$	3.0	—	—	V	$I_R = 100\ \mu\text{A}$
<b>Red, Device Series HDSP-390x</b>						
Luminous Intensity/Segment (Digital Average) <sup>a, b</sup>	$I_V$	—	10.30	—	mcd	$I_F = 20\text{ mA}$
Forward Voltage/Segment or DP <sup>c</sup>	$V_F$	—	2.05	2.5	V	$I_F = 20\text{ mA}$
Peak Wavelength	$\lambda_p$	—	631	—	nm	—
Dominant Wavelength <sup>d</sup>	$\lambda_d$	—	622	—	nm	—
Reverse Voltage/Segment or DP <sup>e</sup>	$V_R$	3.0	—	—	V	$I_R = 100\ \mu\text{A}$
<b>Yellow, Device Series HDSP-420x</b>						
Luminous Intensity/Segment (Digital Average) <sup>a, b</sup>	$I_V$	—	4.20	—	mcd	$I_F = 20\text{ mA}$
Forward Voltage/Segment or DP <sup>c</sup>	$V_F$	—	2.0	2.5	V	$I_F = 20\text{ mA}$
Peak Wavelength	$\lambda_p$	—	591	—	nm	—
Dominant Wavelength <sup>d</sup>	$\lambda_d$	581.5	588	592.5	nm	—
Reverse Voltage/Segment or DP <sup>e</sup>	$V_R$	3.0	—	—	V	$I_R = 100\ \mu\text{A}$
<b>Green, Device Series HDSP-860x</b>						
Luminous Intensity/Segment (Digital Average) <sup>a, b</sup>	$I_V$	1.54	5.70	—	mcd	$I_F = 10\text{ mA}$
Forward Voltage/Segment or DP <sup>c</sup>	$V_F$	—	2.1	2.5	V	$I_F = 10\text{ mA}$
Peak Wavelength	$\lambda_p$	—	572	—	nm	—
Dominant Wavelength <sup>d</sup>	$\lambda_d$	—	571	577	nm	—
Reverse Voltage/Segment or DP <sup>e</sup>	$V_R$	3.0	—	—	V	$I_R = 100\ \mu\text{A}$

- The luminous intensity,  $I_V$ , is measured at the mechanical axis of the package.
- The optical axis is closely aligned with the mechanical axis of the package.
- The forward voltage tolerance is  $\pm 0.1\text{V}$ .
- The dominant wavelength,  $\lambda_d$ , is derived from the CIE Chromaticity Diagram and represents the perceived color of the device.
- The typical specification is for reference only. Do not exceed absolute maximum ratings, and long-term reverse bias is not recommended.

## Part Numbering System

5082 - X X X X - X X X X X

HDSP- X X X X - X X X X X

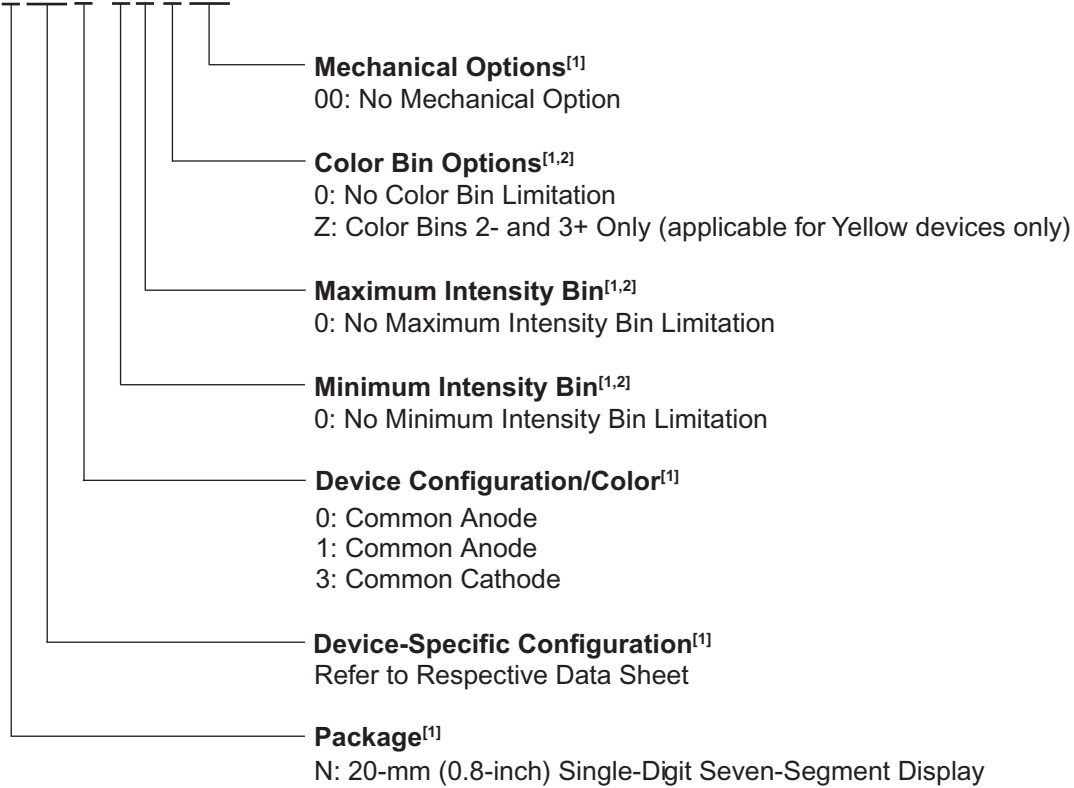

1. For codes not listed in the figure above, refer to the respective data sheet or contact your nearest Broadcom representative for details.

2. Bin options refer to shippable bins for a part number. Color and Intensity Bins are typically restricted to 1 bin per tube (exceptions may apply). Refer to the respective data sheet for specific bin limit information.

# Intensity Bin Limits (mcd)

**Table 1: Deep Red: HDSP-N15x**

IV Bin Category	Min.	Max.
J	6.14	11.20
K	9.20	16.90
L	13.80	25.30
M	20.70	38.00
N	31.10	56.90
O	46.60	85.40

**Table 4: Red: HDSP-390x**

IV Bin Category	Min.	Max.
D	3.35	6.14
E	5.02	9.21
F	7.53	13.82
G	11.30	20.72
H	16.95	31.08
I	25.43	46.62

**Table 2: Yellow: HDSP-420x**

IV Bin Category	Min.	Max.
C	2.23	4.09
D	3.35	6.14
E	5.02	9.21
F	7.53	13.82
G	11.30	20.72
H	16.95	31.08
I	25.43	46.62

**Table 5: Color Categories**

Color	Bin	Dominant Wavelength (nm)	
		Min.	Max.
Yellow	1	581.50	585.00
	3	584.00	587.50
	2	586.50	590.00
	4	589.00	592.50
Green	2	573.00	577.00
	3	570.00	574.00
	4	567.00	571.00
	5	564.00	568.00

**Table 3: Green: HDSP-860x**

IV Bin Category	Min.	Max.
E	1.54	2.82
F	2.31	4.25
G	3.47	6.37
H	5.21	9.55
I	7.81	14.32
J	11.72	21.48

**NOTE:** All categories are established for classification of products. Products may not be available in all categories. Contact your Broadcom representatives for further clarification or information.

# Deep Red Graphs

Figure 1: Relative Intensity vs. Wavelength

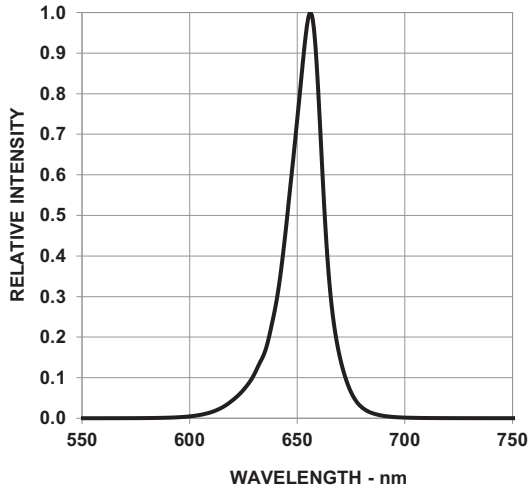

Figure 2: Forward Current vs. Forward Voltage

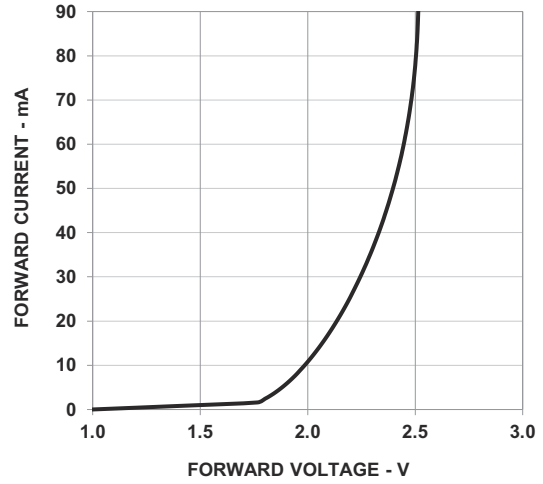

Figure 3: Relative Luminous Intensity vs. Forward Current

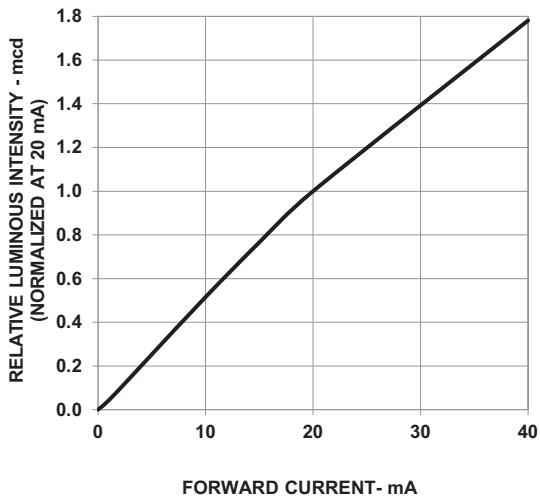
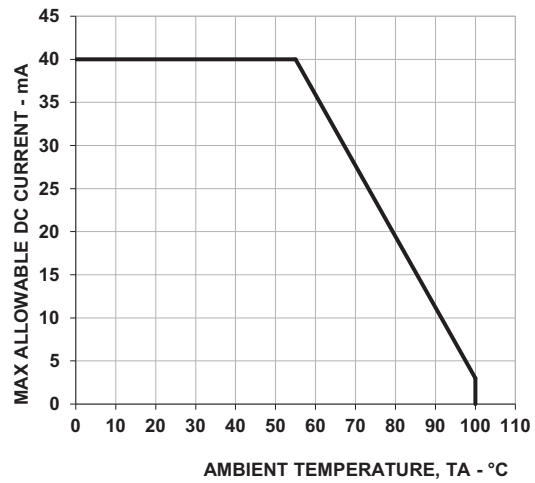

Figure 4: Maximum Forward Current vs. Ambient Temperature



# Red Graphs

Figure 5: Relative Intensity vs. Wavelength

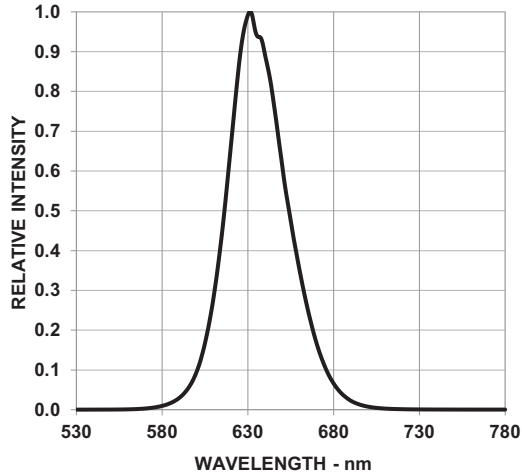

Figure 6: Forward Current vs. Forward Voltage

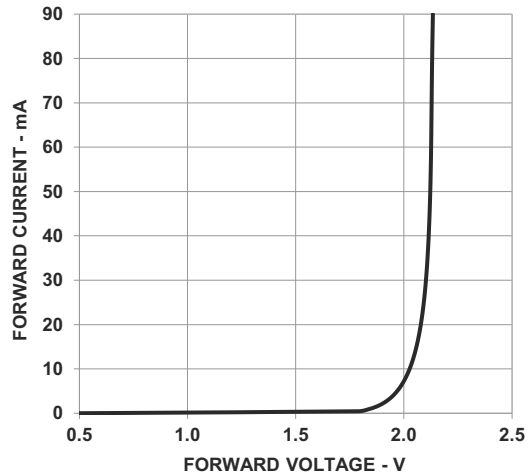

Figure 7: Relative Luminous Intensity vs. Forward Current

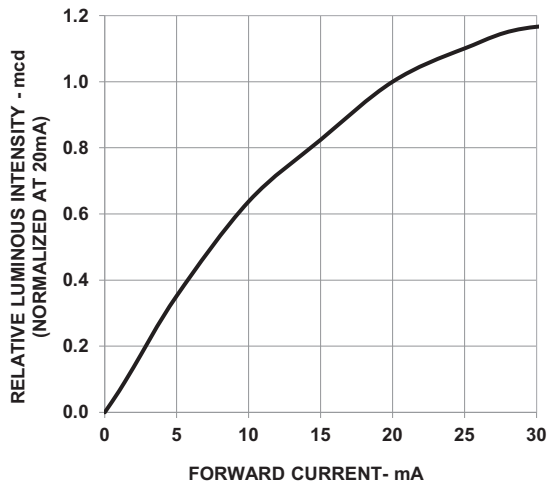
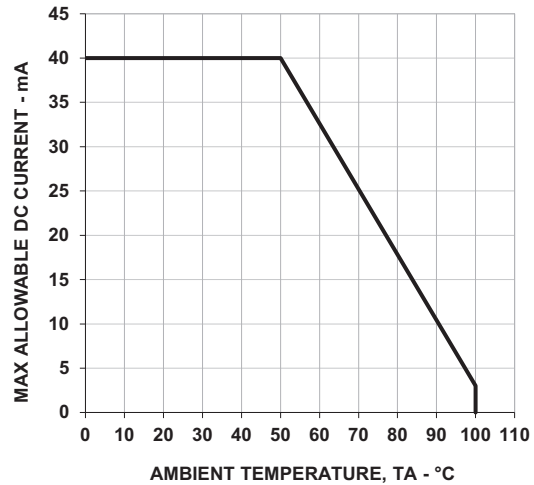

Figure 8: Maximum Forward Current vs. Ambient Temperature





# Green Graphs

Figure 9: Relative Intensity vs. Wavelength

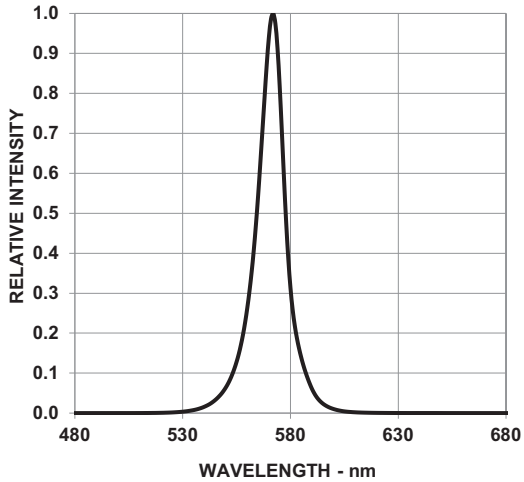

Figure 10: Forward Current vs. Forward Voltage

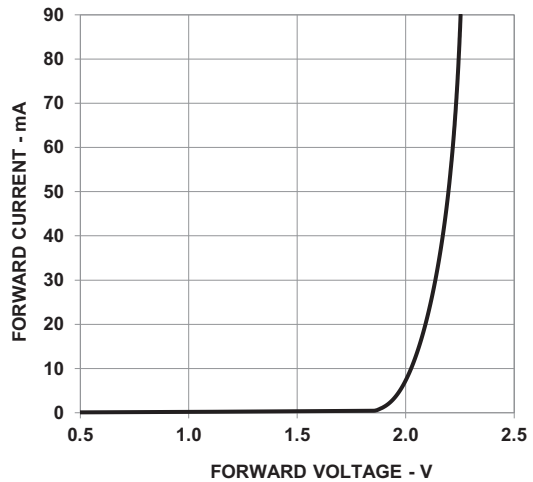

Figure 11: Relative Luminous Intensity vs. Forward Current

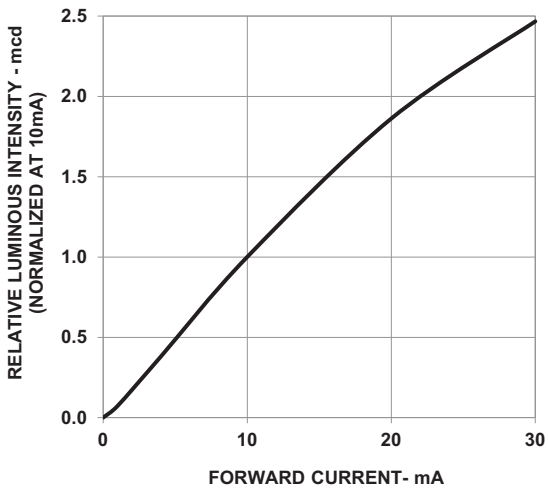
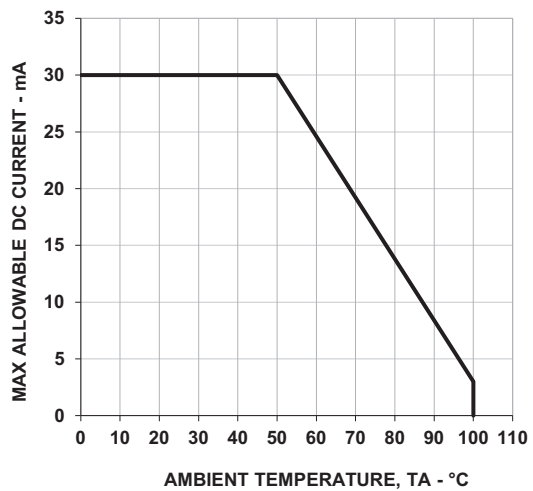

Figure 12: Maximum Forward Current vs. Ambient Temperature



# Yellow Graphs

Figure 13: Relative Intensity vs. Wavelength

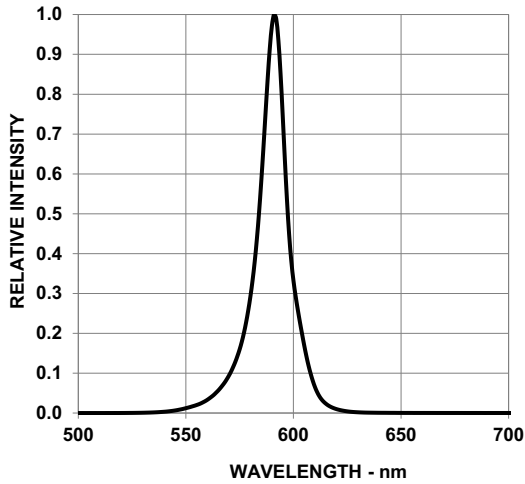

Figure 14: Forward Current vs. Forward Voltage

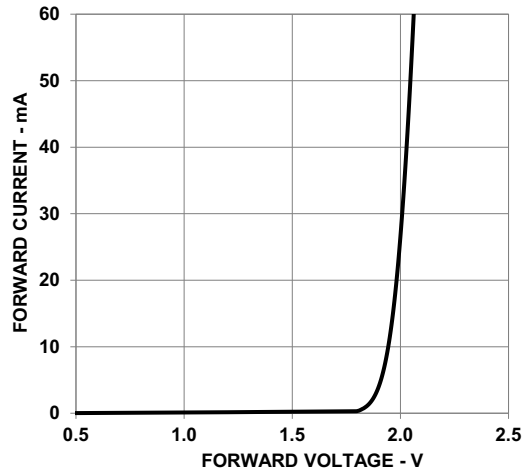

Figure 15: Relative Luminous Intensity vs. Forward Current

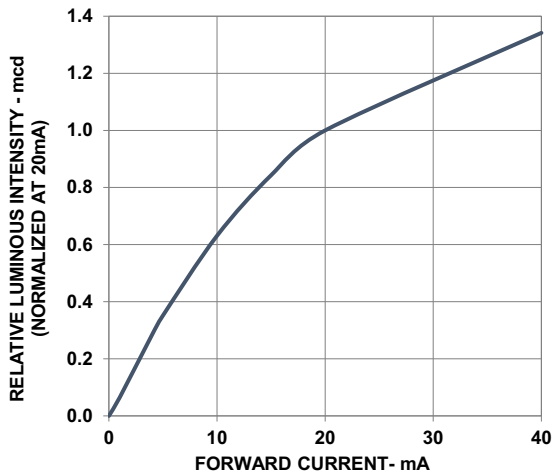
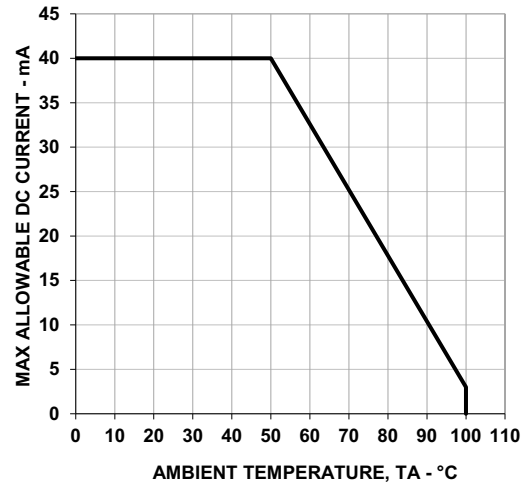

Figure 16: Maximum Forward Current vs. Ambient Temperature



## Precautionary Notes

### Soldering and Handling Precautions

- Set and maintain the wave soldering parameters according to the recommended temperature and dwell time. Perform daily checks on the profile to ensure that it is always conforming to the recommended conditions. Exceeding these conditions will over-stress the LEDs and cause premature failures.
- Use only bottom preheaters to reduce thermal stress experienced by the LEDs.
- Recalibrate the soldering profile before loading a new type of a PCB. PCBs with different sizes and designs (component density) will have different heat capacities and might cause a change in temperature experienced by the PCB if the same wave soldering setting is used.
- Do not perform wave soldering more than once.
- Any alignment fixture used during wave soldering must be loosely fitted and must not apply stress on the LEDs. Use non-metal material because it will absorb less heat during the wave soldering process.
- At elevated temperatures, the LEDs are more susceptible to mechanical stress. Allow the PCB to be sufficiently cooled to room temperature before handling. Do not apply stress to the LED when it is hot.
- Use wave soldering to solder the LED. Use hand soldering only for rework or touch up if unavoidable, but it must be strictly controlled to following conditions:
  - Soldering iron tip temperature = 315°C maximum.
  - Soldering duration = 2 seconds maximum.
  - Number of cycles = 1 only.
  - Power of soldering iron = 50W maximum.
- For ESD-sensitive devices, apply proper ESD precautions at the soldering station. Use only an ESD-safe soldering iron.
- Do not touch the LED package body with the soldering iron except for the soldering terminals because it may cause damage to the LED.
- Confirm beforehand whether the functionality and performance of the LED is affected by soldering with hand soldering.
- Keep the heat source at least 1.6 mm away from the LED body during soldering.
- Design an appropriate hole size to avoid problems during insertion.
- Cleaning agents from the ketone family (acetone, methyl ethylketone, and so on) and from the chlorinated hydrocarbon family (methylene chloride,

trichloroethylene, carbon tetrachloride, and so on) are not recommended for cleaning the LED displays. All of these various solvents attack or dissolve the encapsulating epoxies used to form the package of plastic LED parts.

- For the purpose of cleaning, wash with DI water only. The cleaning process should take place at room temperature only. Clear any water or moisture from the LED display immediately after washing.
- Use of *No clean* solder paste is recommended for soldering.

Figure 17: Recommended Wave Soldering Profile

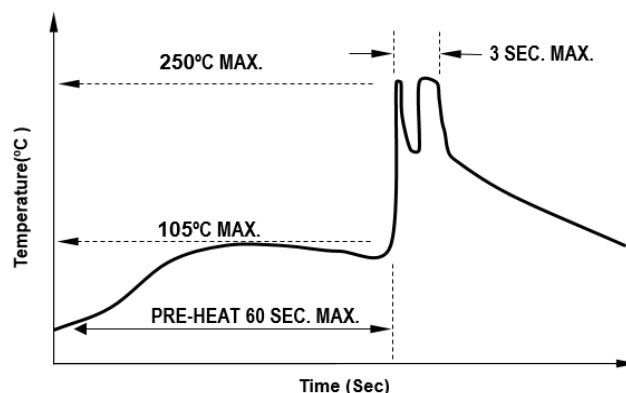

**NOTE:** Figure 17 refers to measurements with thermocouple mounted at the bottom of the PCB.

### Application Precautions

- The drive current of the LED must not exceed the maximum allowable limit across temperatures as stated in the data sheet. Constant current driving is recommended to ensure consistent performance.
- Circuit design must cater to the whole range of forward voltage ( $V_F$ ) of the LEDs to ensure the intended drive current can always be achieved.
- The LED exhibits slightly different characteristics at different drive currents, which may result in a larger variation of performance (such as intensity, wavelength, and forward voltage). Set the application current as close as possible to the test current to minimize these variations.
- The LED is not intended for reverse bias. Use other appropriate components for such purposes. When driving the LED in matrix form, ensure that the reverse bias voltage does not exceed the allowable limit of the LED.

- Avoid rapid change in ambient temperatures, especially in high-humidity environments, because they cause condensation on the LED.
- If the LED is intended to be used in a harsh or outdoor environment, protect the LED against damages caused by rain, water, dust, oil, corrosive gases, external mechanical stresses, and so on.

## Eye Safety Precautions

LEDs may pose optical hazards when in operation. Do not look directly at operating LEDs because it might be harmful to the eyes. For safety reasons, use appropriate shielding or personal protective equipment.

## Disclaimer

Broadcom's products and software are not specifically designed, manufactured, or authorized for sale as parts, components, or assemblies for the planning, construction, maintenance, or direct operation of a nuclear facility or for use in medical devices or applications. The customer is solely responsible, and waives all rights to make claims against Broadcom or its suppliers, for all loss, damage, expense, or liability in connection with such use.

Copyright © 2005–2024 Broadcom. All Rights Reserved. The term "Broadcom" refers to Broadcom Inc. and/or its subsidiaries. For more information, go to [www.broadcom.com](http://www.broadcom.com). All trademarks, trade names, service marks, and logos referenced herein belong to their respective companies.

Broadcom reserves the right to make changes without further notice to any products or data herein to improve reliability, function, or design. Information furnished by Broadcom is believed to be accurate and reliable. However, Broadcom does not assume any liability arising out of the application or use of this information, nor the application or use of any product or circuit described herein, neither does it convey any license under its patent rights nor the rights of others.



Lead (Pb) Free  
RoHS Compliant