

ASMB-LTC2-0A335

2121 Tricolor PLCC-4 LED

Description

The Broadcom[®] ASMB-LTC2 is a tricolor LED device in PLCC-4 LED with size 2.1 mm × 2.1 mm. The full black body package help to further enhance the display contrast make it suitable for full color sign application.

To facilitate easy pick-and-place assembly, the LEDs are packed in tape and reel form. Every reel is shipped in single intensity and color bin to ensure uniformity.

Features

- Black body appearance
- Diffused encapsulation
- Compatible with reflow soldering process

Applications

- Indoor full color sign displays

CAUTION! This LED is ESD sensitive. Please observe appropriate precautions during handling and processing. Refer to application note AN-1142 for additional details.

Figure 1: Package Drawing

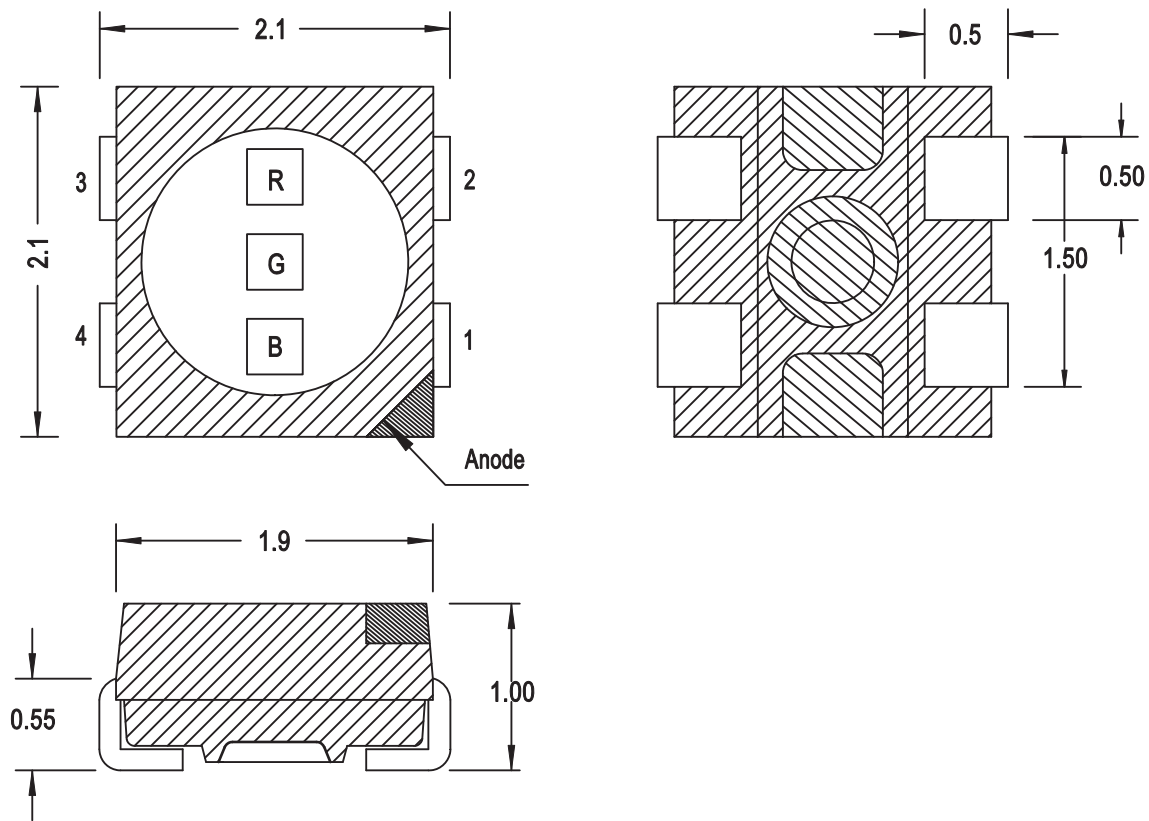

Pin	Configuration
1	Anode
2	Red Cathode
3	Green Cathode
4	Blue Cathode

NOTE:

1. All dimensions in millimeters (mm).
2. Tolerance is ± 0.20 mm unless otherwise specified.
3. Encapsulation = silicone.
4. Terminal finish = silver plating.

Absolute Maximum Rating

Parameters	Red	Green	Blue	Unit
DC Forward Current ^a	25	15	15	mA
Peak Forward Current ^b	100	100	100	mA
Power Dissipation	62.5	51	51	mW
Reverse Voltage	Not recommended for reverse bias operation			
LED Junction Temperature	110			°C
Operating Temperature Range	-40 to +85			°C
Storage Temperature Range	-40 to +100			°C

a. Derate linearly as shown in Figure 8.

b. Duty factor = 10%, frequency = 1 kHz.

Optical Characteristics (T_J = 25°C)

Test Current: Red = 5 mA, Green = 5 mA, Blue = 5 mA.

Color	Luminous Intensity, I _V (mcd) ^a			Dominant Wavelength, λ _d (nm) ^b			Peak Wavelength, λ _p (nm)	Viewing Angle, 2θ _½ (°) ^c
	Min.	Typ.	Max.	Min.	Typ.	Max.	Typ.	Typ.
Red	56.0	70.0	112.5	618	621	628	630	105
Green	224.0	300.0	450.0	520	525	532	516	105
Blue	35.5	50.0	71.5	465	468	473	465	105

a. The luminous intensity, I_V is measured at the mechanical axis of the package and it is tested with a single current pulse condition. The actual peak of the spatial radiation pattern may not be aligned with the axis.

b. The dominant wavelength, λ_d is derived from the CIE Chromaticity Diagram and represents the perceived color of the device.

c. θ_½ is the off-axis angle where the luminous intensity is half of the peak intensity.

Electrical Characteristics (T_J = 25°C)

Color	Forward Voltage V _F (V) ^a			Reverse Voltage, V _R (V) at I _R = 10 μA ^b	Thermal Resistance, R _{θJ-S} (°C/W) ^c	
	Min.	Typ.	Max.	Max.	1 Chip On	3 Chips On
Red	1.6	2.0	2.3	4.0	500	500
Green	2.5	2.7	3.4	4.0	680	680
Blue	2.5	2.7	3.4	4.0	680	680

a. Forward voltage tolerance is ± 0.1V. Test current red = 5 mA, Green = 5 mA, Blue = 5 mA.

b. Indicates product final test condition. Long term reverse bias is not recommended.

c. Thermal resistance from LED junction to solder point.

Part Numbering System

A S M B - L T x₁ 2 - 0 x₂ x₃ x₄ x₅

Code	Description	Option	
x ₁	Package Type	C	Black body
x ₂	Minimum Intensity Bin	A	Red = Bin P2 Bin P2, Q1, Q2
			Green = Bin S2 Bin S2, T1, T2
			Blue = Bin N2 Bin N2, P1, P2
x ₃	Number of Intensity Bins	3	3 Intensity Bins from minimum
x ₄	Color Bin Option	3	Red = Full distribution
			Green = Bin A, B, C
			Blue = Bin A, B, C
x ₅	Test Option	5	Test Current: Red 5 mA, Green 5 mA, Blue 5 mA

Example of bin information on reel and packaging label:

CAT: P2 S2 N2 – Red intensity bin P2
 – Green intensity bin S2
 – Blue intensity N2

BIN: AB – Green color bin A
 – Blue color bin B

Bin Information

Intensity Bin Limits (CAT)

Bin ID	Luminous Intensity, I_v (mcd)	
	Min.	Max.
Red		
P2	56.0	71.5
Q1	71.5	90.0
Q2	90.0	112.5
Green		
S2	224.0	285.0
T1	285.0	355.0
T2	355.0	450.0
Blue		
N2	35.5	45.0
P1	45.0	56.0
P2	56.0	71.5

Tolerance = $\pm 12\%$

Color Bin Limits (BIN) – Red

Bin ID	Dominant Wavelength, λ_d (nm)		Chromaticity Coordinates	
	Min.	Max.	x	y
—	618	628	0.6873	0.3126
			0.6837	0.3128
			0.7014	0.2952
			0.7052	0.2948

Tolerance = ± 1.0 nm

Color Bin Limits (BIN) – Green

Bin ID	Dominant Wavelength, λ_d (nm)		Chromaticity Coordinates	
	Min.	Max.	x	y
A	520	526	0.0743	0.8338
			0.1520	0.6837
			0.1856	0.6759
			0.1223	0.8228
B	523	529	0.0979	0.8316
			0.1685	0.6821
			0.2027	0.6673
			0.1468	0.8104
C	526	532	0.1223	0.8228
			0.1856	0.6759
			0.2191	0.6576
			0.1702	0.7965

Tolerance = ± 1.0 nm

Color Bin Limits (BIN) – Blue

Bin ID	Dominant Wavelength, λ_d (nm)		Chromaticity Coordinates	
	Min.	Max.	x	y
A	465	469	0.1355	0.0399
			0.1493	0.0604
			0.1411	0.0730
			0.1267	0.0534
B	467	471	0.1314	0.0459
			0.1455	0.0660
			0.1363	0.0815
			0.1215	0.0626
C	469	473	0.1267	0.5343
			0.1411	0.0730
			0.1310	0.0918
			0.1158	0.0736

Tolerance = ± 1.0 nm

Figure 2: Spectral Power Distribution

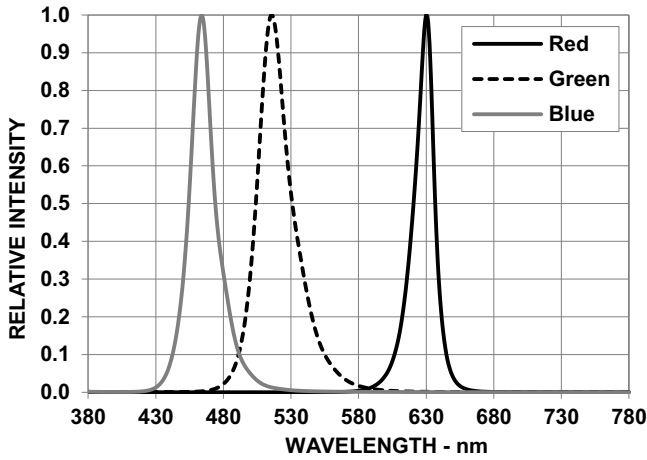

Figure 3: Forward Current vs. Forward Voltage

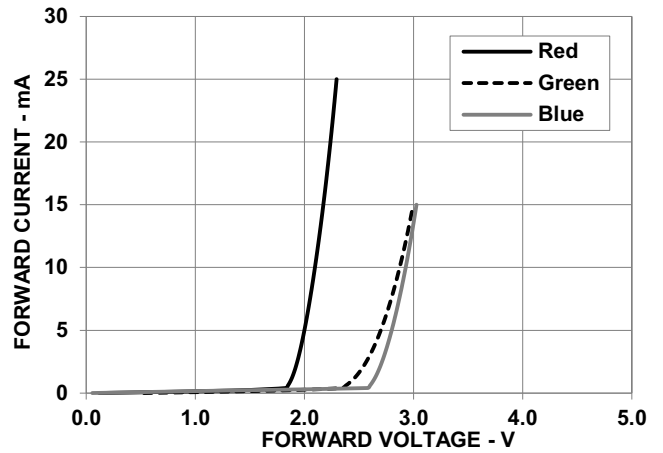

Figure 4: Relative Luminous Intensity vs. Mono Pulse Current

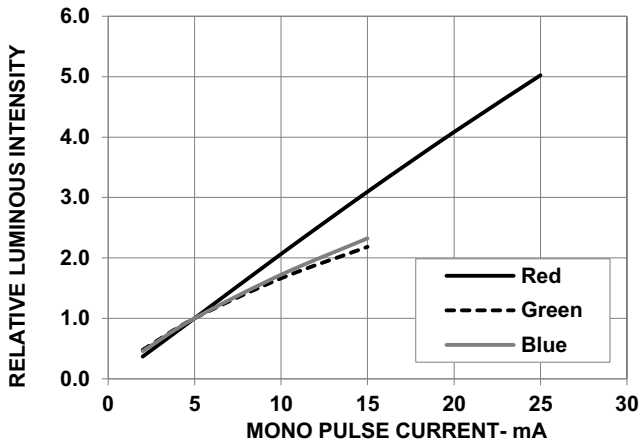

Figure 5: Dominant Wavelength Shift vs. Mono Pulse Current

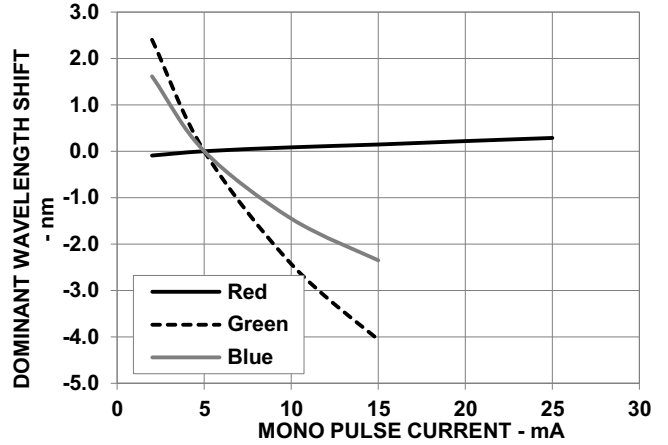

Figure 6: Relative Light Output vs. Junction Temperature

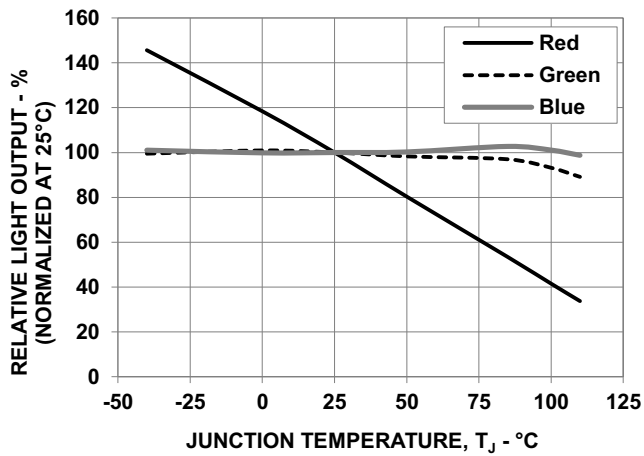

Figure 7: Forward Voltage Shift vs. Junction Temperature

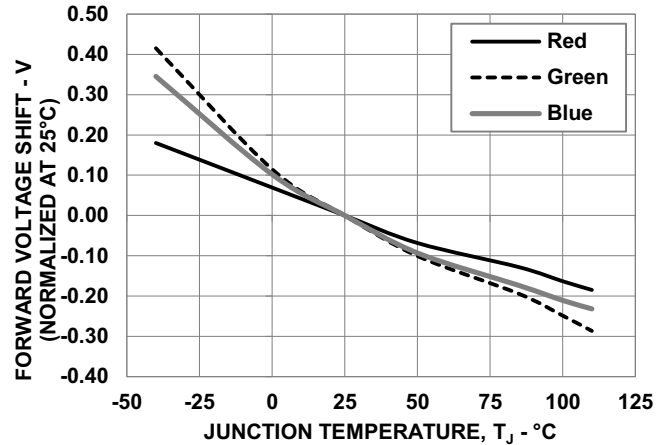

Figure 8: Maximum Forward Current vs. Temperature for Red, Green, and Blue

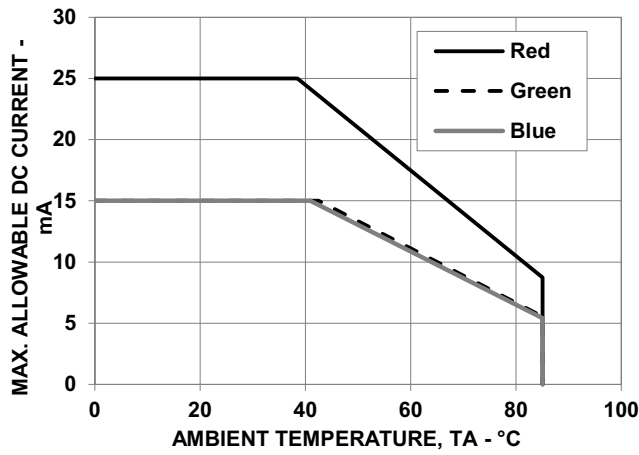
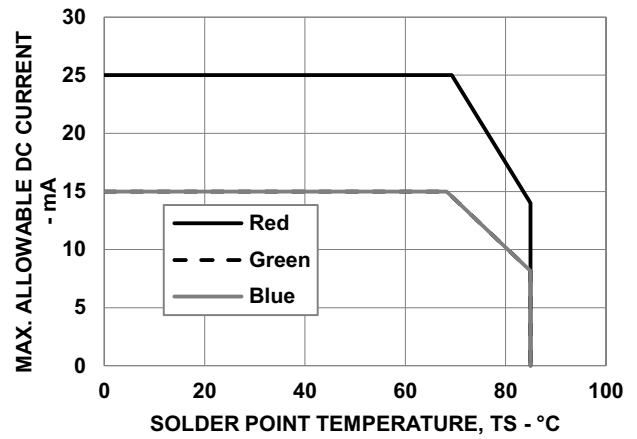

Figure 9: Maximum Forward Current vs. Solder Temperature for Red, Green, and Blue



NOTE: Maximum forward current graphs based on ambient temperature (T_A) above are with reference to the thermal resistance $R_{\theta J-A}$ in the following table. See [Precautionary Notes](#) for more details.

Condition	Thermal Resistance from LED Junction to Ambient, $R_{\theta J-A}$ (°C/W)		
	Red	Green	Blue
3 chips on	1100	1280	1280

Figure 10: Radiation Pattern for X-axis

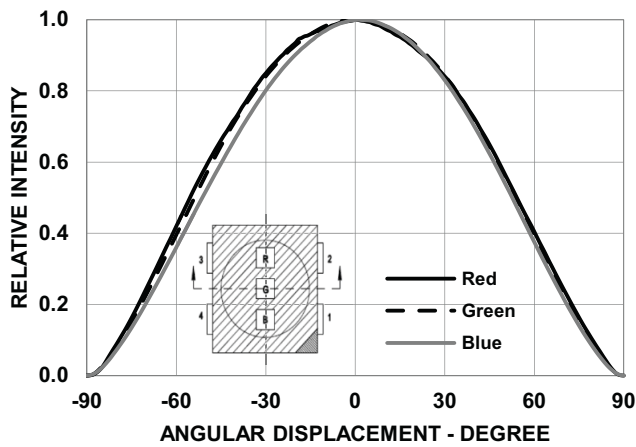

Figure 11: Radiation Pattern for Y-axis

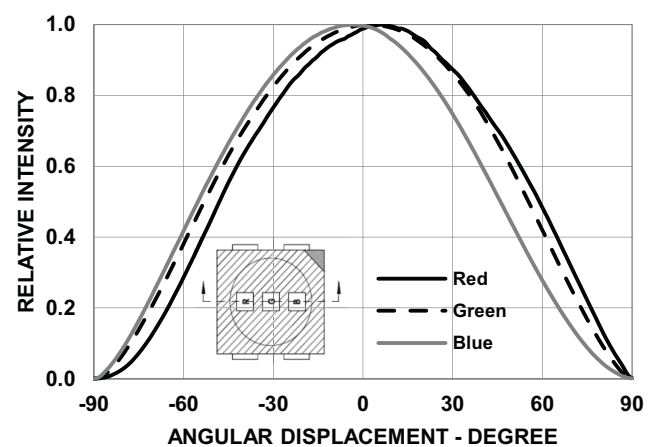
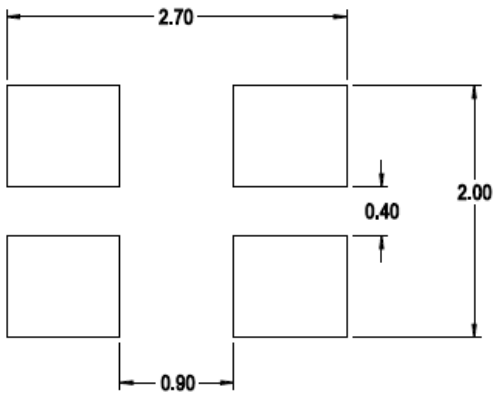
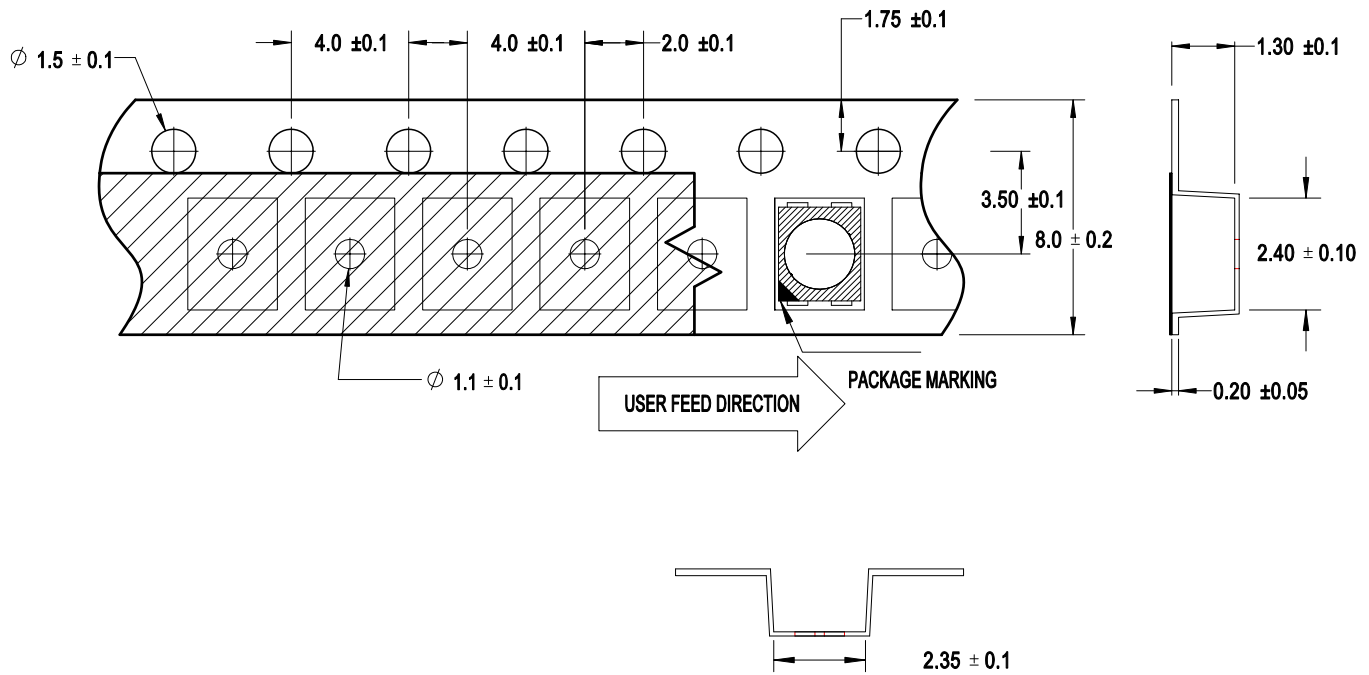

Figure 12: Recommended Soldering Pad Pattern



NOTE: All dimensions are in millimeters (mm).

Figure 13: Carrier Tape Dimensions



NOTE: All dimensions are in millimeters (mm).

Figure 14: Reel Dimensions

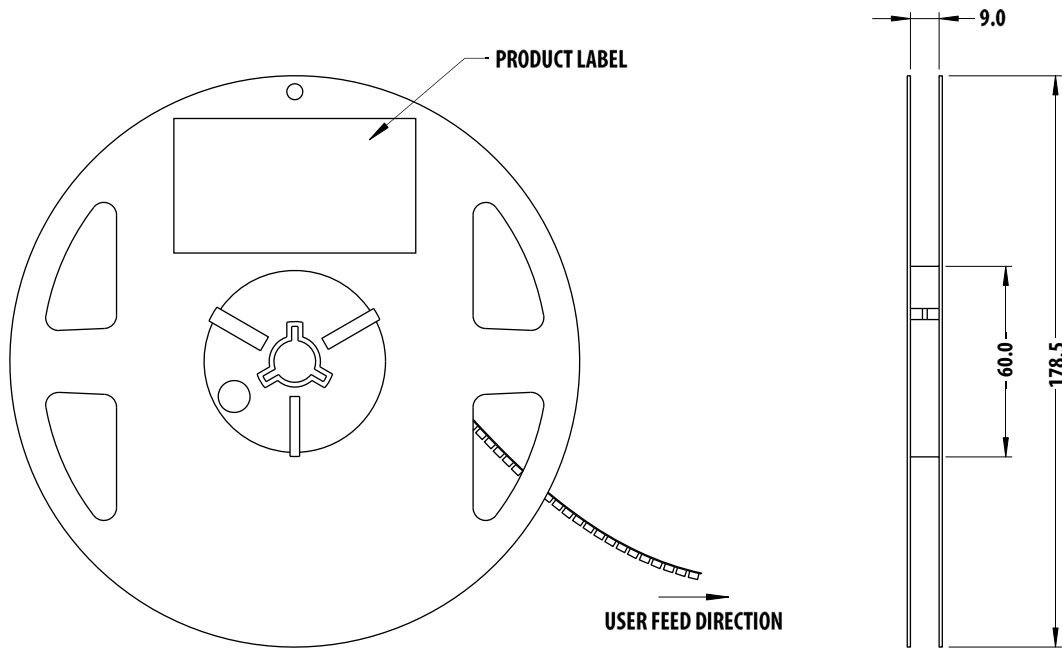

NOTE: All dimensions are in millimeters.

Precautionary Notes

Soldering

- Do not perform reflow soldering more than twice. Observe necessary precautions of handling moisture-sensitive device as stated in the following section.
- Do not apply any pressure or force on the LED during reflow and after reflow when the LED is still hot.
- Use reflow soldering to solder the LED. Use hand soldering only for rework if unavoidable, but it must be strictly controlled to following conditions:
 - Soldering iron tip temperature = 315°C maximum
 - Soldering duration = 3 seconds maximum
 - Number of cycles = 1 only
 - Power of soldering iron = 50W maximum
- Do not touch the LED package body with the soldering iron except for the soldering terminals, as it may cause damage to the LED.
- Confirm beforehand whether the functionality and performance of the LED is affected by soldering with hand soldering.

Figure 15: Recommended Lead-Free Reflow Soldering Profile

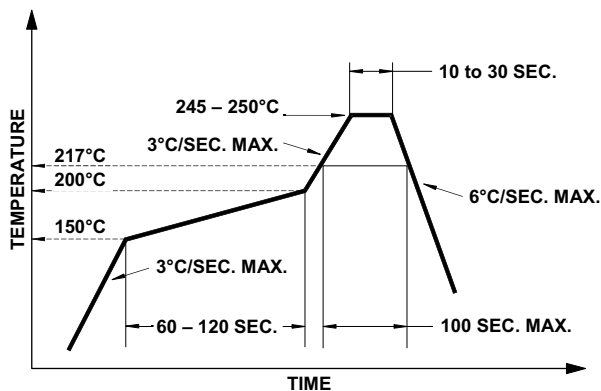
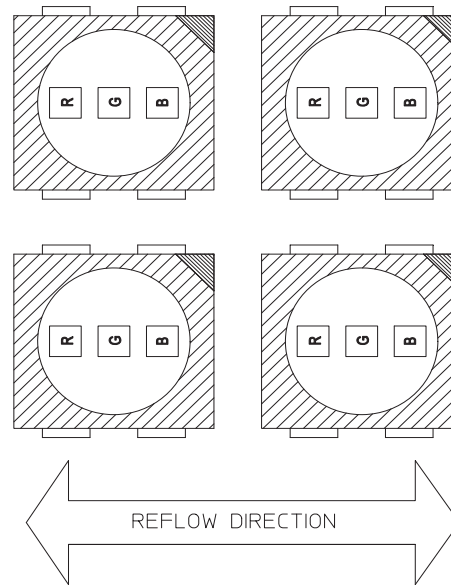

Figure 16: Recommended Board Reflow Direction



Handling Precautions

The encapsulation material of the LED is made of silicone for better product reliability. Compared to epoxy encapsulant, which is hard and brittle, silicone is softer and flexible. Observe special handling precautions during assembly of silicone encapsulated LED products. Failure to comply might lead to damage and premature failure of the LED. Refer to Broadcom Application Note AN5288, *Silicone Encapsulation for LED: Advantages and Handling Precautions*, for additional information.

- Do not poke sharp objects into the silicone encapsulant. Sharp objects, such as tweezers or syringes, might apply excessive force or even pierce through the silicone and induce failures to the LED die or wire bond.
- Do not touch the silicone encapsulant. Uncontrolled force acting on the silicone encapsulant might result in excessive stress on the wire bond. Hold the LED only by the body.
- Do not stack assembled PCBs together. Use an appropriate rack to hold the PCBs.
- Surface of silicone material attracts dust and dirt easier than epoxy due to its surface tackiness. To remove foreign particles on the surface of silicone, use a cotton bud with isopropyl alcohol (IPA). During cleaning, rub the surface gently without putting too much pressure on the silicone. Ultrasonic cleaning is not recommended.

- For automated pick and place, Broadcom has tested a nozzle size with OD 1.5 mm to work with this LED. However, due to the possibility of variations in other parameters such as pick and place machine maker/model, and other settings of the machine, verify that the selected nozzle will not cause damage to the LED.

Handling of Moisture-Sensitive Devices

This product has a Moisture Sensitive Level 5a rating per JEDEC J-STD-020. Refer to Broadcom Application Note AN5305, *Handling of Moisture Sensitive Surface Mount Devices* for additional details and a review of proper handling procedures.

Before use:

- An unopened moisture barrier bag (MBB) can be stored at <40°C/90% RH for 12 months. If the actual shelf life has exceeded 12 months and the humidity indicator card (HIC) indicates that baking is not required, then it is safe to reflow the LEDs per the original MSL rating.
- Do not open the MBB prior to assembly (for example, for IQC). If unavoidable, MBB must be properly resealed with fresh desiccant and HIC. The exposed duration must be taken in as floor life.

Control after opening the MBB:

- Read the HIC immediately upon opening of MBB.
- Keep the LEDs at <30°/60%RH at all times, and complete all high temperature-related processes, including soldering, curing or rework within 24 hours.

Control for unfinished reel:

Store unused LEDs in a sealed MBB with desiccant or a desiccator at <5% RH.

Control of assembled boards:

If the PCB soldered with the LEDs is to be subjected to other high-temperature processes, store the PCB in a sealed MBB with desiccant or desiccator at <5% RH to ensure that all LEDs have not exceeded their floor life of 24 hours.

Baking is required if the following conditions exist:

- The HIC indicator indicates a change in color for 10% and 5%, as stated on the HIC.
- The LEDs are exposed to conditions of >30°C/60% RH at any time.
- The LED's floor life exceeded 24 hours.

The recommended baking condition is: 60°C ± 5°C for 20 hours.

Baking can only be done once.

Storage:

The soldering terminals of these Broadcom LEDs are silver plated. If the LEDs are exposed in ambient environment for too long, the silver plating might be oxidized, thus affecting its solderability performance. As such, keep unused LEDs in a sealed MBB with desiccant or in a desiccator at <5% RH.

Application Precautions

- The drive current of the LED must not exceed the maximum allowable limit across temperature as stated in the data sheet. Constant current driving is recommended to ensure consistent performance.
- Circuit design must cater to the whole range of forward voltage (V_F) of the LEDs to ensure the intended drive current can always be achieved.
- The LED exhibits slightly different characteristics at different drive currents, which may result in a larger variation of performance (meaning: intensity, wavelength, and forward voltage). Set the application current as close as possible to the test current to minimize these variations.
- The LED is not intended for reverse bias. Use other appropriate components for such purposes. When driving the LED in matrix form, ensure that reverse bias voltage does not exceed the allowable limit of the LED.
- Do not use the LED in the vicinity of material with sulfur content or in environments of high gaseous sulfur compounds and corrosive elements. Examples of material that might contain sulfur are rubber gaskets, room-temperature vulcanizing (RTV) silicone rubber, rubber gloves, and so on. Prolonged exposure to such environments may affect the optical characteristics and product life.
- Avoid rapid change in ambient temperature, especially in high-humidity environments, because they cause condensation on the LED.

Thermal Management

The optical, electrical, and reliability characteristics of the LED are affected by temperature. Keep the junction temperature (T_J) of the LED below the allowable limit at all times. T_J can be calculated as follows:

$$T_J = T_A + R_{\theta J-A} \times I_F \times V_{Fmax}$$

where:

T_A = Ambient temperature (°C)

$R_{\theta J-A}$ = Thermal resistance from LED junction to ambient (°C/W)

I_F = Forward current (A)

V_{Fmax} = Maximum forward voltage (V)

The complication of using this formula lies in T_A and $R_{\theta J-A}$. Actual T_A is sometimes subjective and hard to determine. $R_{\theta J-A}$ varies from system to system depending on design and is usually not known.

Another way of calculating T_J is by using the solder point temperature, T_S as follows:

$$T_J = T_S + R_{\theta J-S} \times I_F \times V_{Fmax}$$

where:

T_S = LED solder point temperature as shown in the following figure ($^{\circ}\text{C}$)

$R_{\theta J-S}$ = Thermal resistance from junction to solder point ($^{\circ}\text{C}/\text{W}$)

I_F = Forward current (A)

V_{Fmax} = Maximum forward voltage (V)

Figure 17: Solder Point Temperature on PCB

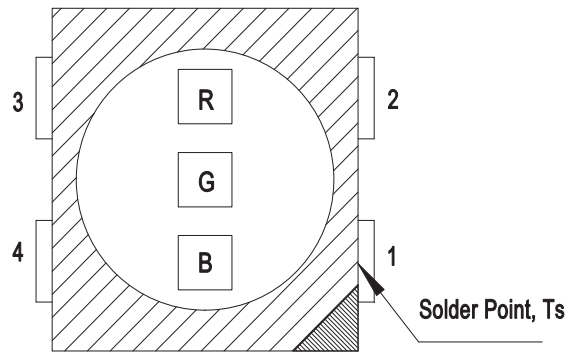

T_S can be easily measured by mounting a thermocouple on the soldering joint as shown in preceding figure, while $R_{\theta J-S}$ is provided in the data sheet. Verify the T_S of the LED in the final product to ensure that the LEDs are operating within all maximum ratings stated in the data sheet.

Eye Safety Precautions

LEDs may pose optical hazards when in operation. Do not look directly at operating LEDs because it might be harmful to the eyes. For safety reasons, use appropriate shielding or personal protective equipment.

Disclaimer

Broadcom's products and software are not specifically designed, manufactured, or authorized for sale as parts, components, or assemblies for the planning, construction, maintenance, or direct operation of a nuclear facility or for use in medical devices or applications. The customer is solely responsible, and waives all rights to make claims against Broadcom or its suppliers, for all loss, damage, expense, or liability in connection with such use.

Broadcom, the pulse logo, Connecting everything, Avago Technologies, Avago, and the A logo are among the trademarks of Broadcom and/or its affiliates in the United States, certain other countries, and/or the EU.

Copyright © 2018–2021 Broadcom. All Rights Reserved.

The term “Broadcom” refers to Broadcom Inc. and/or its subsidiaries. For more information, please visit www.broadcom.com.

Broadcom reserves the right to make changes without further notice to any products or data herein to improve reliability, function, or design. Information furnished by Broadcom is believed to be accurate and reliable. However, Broadcom does not assume any liability arising out of the application or use of this information, nor the application or use of any product or circuit described herein, neither does it convey any license under its patent rights nor the rights of others.



Lead (Pb) Free
RoHS Compliant