



Storage. Networking. Accelerated.™

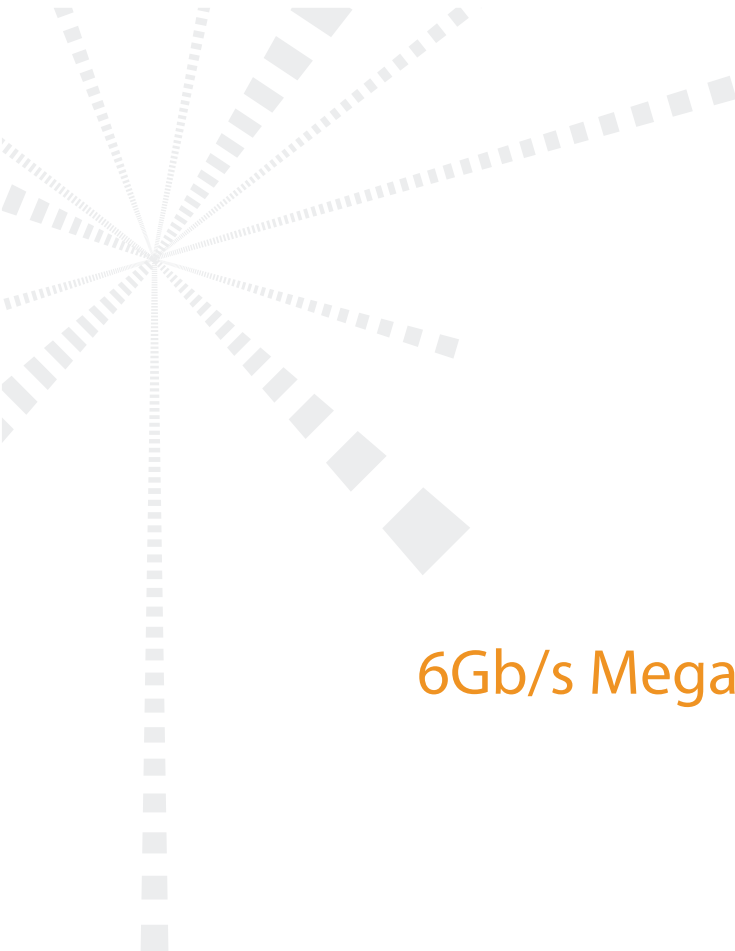
# 6Gb/s MegaRAID® SAS RAID Controllers

## User Guide

41450-04, Rev. D  
October 2013



41450-04D



## Revision History

Version and Date	Description of Changes
41450-04, Rev. D, October 2013	Updated the connector information for the MegaRAID® SAS 9266-4i and SAS 9266-8i controllers. Updated the connector labels for the card layout graphics for the MegaRAID SAS 9266-8i and SAS 9271-8i controllers.
41450-04, Rev. C, August 2013	Updated the environmental conditions for the RAID controllers.
41450-04, Rev. B, February 2013	Updated the environmental conditions for the RAID controllers. Updated this guide to the new template.
41450-04, Rev. A, August 2012	Added the MegaRAID SAS 9270-8i, SAS 9271-4i, SAS 9271-8i, SAS 9271-8iCC, SAS 9286-8e, SAS 9286CV-8e, and SAS 9286CV-8eCC RAID controllers.
41450-03, Rev. A, April 2012	Added the MegaRAID SAS 9265CV-8i, SAS 9266-4i, SAS 9266-8i, and SAS 9285CV-8e RAID controllers.
41450-02, Rev. E, February 2011	Added the MegaRAID SAS 9260CV-4i, SAS 9260CV-8i, SAS 9265-8i, and SAS 9285-8e RAID controllers.
41450-02, Rev. D, June 2010	Added the MegaRAID SAS 9260-16i, SAS 9280-16i4e, and SAS 9280-24i4e RAID controllers.
41450-02, Rev. C, April 2010	Put this guide in the new template.
41450-02, Rev. B, November 2009	Added the MegaRAID SAS 9240-4i, SAS 9240-8i, SAS 9261-8i, and SAS 9280-4i4e RAID controllers.
41450-02, Rev. A, July 2009	Added the MegaRAID SAS 9260-4i, SAS 9260DE-8i, SAS 9280-8e, and SAS 9280DE-8e RAID controllers.
41450-01, Rev. A, June 2009	Added the MegaRAID SAS 9260-8i RAID controller.
41450-00, Rev. A, March 2009	Initial release of this document.

LSI, the LSI & Design logo, Storage.Networking.Accelerated., CacheCade, CacheVault, Fusion-MPT, MegaRAID, MegaRAID Storage Manager, and SafeStore are trademarks or registered trademarks of LSI Corporation in the United States and/or other countries. The PowerPC name and logo are registered trademarks of IBM Corp. and used under license therefrom. All other brand and product names may be trademarks of their respective companies.

LSI Corporation reserves the right to make changes to the product(s) or information disclosed herein at any time without notice. LSI Corporation does not assume any responsibility or liability arising out of the application or use of any product or service described herein, except as expressly agreed to in writing by LSI Corporation; nor does the purchase, lease, or use of a product or service from LSI Corporation convey a license under any patent rights, copyrights, trademark rights, or any other of the intellectual property rights of LSI Corporation or of third parties. LSI products are not intended for use in life-support appliances, devices, or systems. Use of any LSI product in such applications without written consent of the appropriate LSI officer is prohibited.

**Corporate Headquarters**  
San Jose, CA  
800-372-2447

**Website**  
[www.lsi.com](http://www.lsi.com)

Document Number: 41450-04, Rev. D  
Copyright © 2013 LSI Corporation  
All Rights Reserved

---

# Table of Contents

<b>Chapter 1: Overview</b> .....	<b>5</b>
1.1 Overview .....	5
1.1.1 MegaRAID SATA+SAS Controllers with Disk Encryption Support .....	5
1.1.2 MegaRAID SATA+SAS Controllers with Support for Battery Backup Units and CacheVault Modules .....	6
1.1.3 SAS/SATA Standards and Communication Protocols .....	6
1.2 General Description .....	7
1.3 6Gb/s MegaRAID SATA+SAS RAID Controller Detailed Descriptions .....	7
1.3.1 MegaRAID SAS 9240 RAID Controllers .....	7
1.3.2 MegaRAID SAS 9260 RAID Controllers .....	7
1.3.3 MegaRAID SAS 9261 RAID Controller .....	8
1.3.4 MegaRAID SAS 9265 RAID Controllers .....	8
1.3.5 MegaRAID SAS 9266 RAID Controllers .....	8
1.3.6 MegaRAID SAS 9270 RAID Controller .....	8
1.3.7 MegaRAID SAS 9271 RAID Controllers .....	8
1.3.8 MegaRAID SAS 9280 RAID Controllers .....	9
1.3.9 MegaRAID SAS 9285 RAID Controllers .....	9
1.3.10 MegaRAID SAS 9286 RAID Controllers .....	9
1.4 Configuration Scenarios .....	9
1.5 Benefits of the SAS Interface .....	11
1.5.1 PCIe Architecture .....	11
1.5.2 Operating System Support .....	11
1.6 Summary of 6Gb/s MegaRAID SATA+SAS RAID Controller Characteristics .....	12
1.6.1 SAS Features .....	13
1.6.2 SAS Array Limitations .....	13
1.6.3 SATA III Features .....	14
1.6.4 PCIe Performance .....	14
1.6.5 Usability Features .....	14
1.6.6 Flexibility Features .....	15
1.6.7 Drive Roaming .....	15
1.6.8 Drive Migration .....	15
1.7 Hardware Specifications .....	16
1.8 Technical Support .....	19
<b>Chapter 2: MegaRAID SAS Hardware Installation</b> .....	<b>20</b>
2.1 Requirements .....	20
2.2 Quick Installation .....	20
2.3 Detailed Installation .....	21
2.4 After Installing the RAID Controller .....	23
2.5 SAS Device Cables and Connectors .....	23
2.5.1 Connecting a SAS RAID Controller with Internal Connectors to the Drives .....	25
2.5.2 Connecting a RAID Controller with External Connectors to a Drive Enclosure .....	26
<b>Chapter 3: MegaRAID SAS RAID Controller Characteristics</b> .....	<b>28</b>
3.1 6Gb/s MegaRAID SAS RAID Controller Family .....	28
3.1.1 MegaRAID SAS 9240 RAID Controllers .....	28
3.1.2 MegaRAID SAS 9260 RAID Controllers .....	29
3.1.3 MegaRAID SAS 9261 RAID Controller .....	38
3.1.4 MegaRAID SAS 9265 RAID Controllers .....	39
3.1.5 MegaRAID SAS 9266 RAID Controllers .....	44
3.1.6 MegaRAID SAS 9270 RAID Controller .....	47
3.1.7 MegaRAID SAS 9271 RAID Controllers .....	49

---

3.1.8 MegaRAID SAS 9280 RAID Controllers .....	52
3.1.9 MegaRAID SAS 9285 RAID Controllers .....	58
3.1.10 MegaRAID SAS 9286 RAID Controllers .....	62
3.2 MegaRAID SAS 6Gb/s RAID Controller Characteristics .....	67
3.3 Technical Specifications .....	67
3.3.1 RAID Controller Specifications .....	69
3.3.2 Array Performance Features .....	72
3.3.3 Fault Tolerance .....	72
3.3.4 Electrical Characteristics and Environmental Conditions .....	73
3.3.5 Safety Characteristics .....	88
<b>Glossary .....</b>	<b>89</b>

---

## Chapter 1: Overview

This document is the primary reference and user's guide for the LSI® MegaRAID® SATA+SAS RAID controllers based on the 6Gb/s SAS/SATA RAID on a chip devices. This document contains complete installation instructions for these RAID controllers and includes specifications for them.

### 1.1 Overview

The MegaRAID 6Gb/s SAS RAID controllers are high-performance intelligent PCI Express® (PCIe®)-to-SATA+SAS controllers with RAID control capability. The MegaRAID 6Gb/s SAS RAID controllers provide reliability, high-performance, and fault-tolerant drive subsystem management. They are an ideal RAID solution for the internal storage of workgroup, departmental, and enterprise systems. The MegaRAID 6Gb/s SAS RAID controllers offer a cost-effective way to implement RAID in a server.

SAS technology brings a wealth of options and flexibility with the use of SAS and SATA devices within the same storage infrastructure. However, SAS devices and SATA devices bring individual characteristics that make each one a more suitable choice depending on your storage needs. MegaRAID controllers offer the flexibility to combine these two similar technologies on the same controller and within the same enclosure.

**NOTE** You can have both SAS drives and SATA drives within the same virtual drive, too; however, the practice is strongly discouraged.

LSI offers a family of MegaRAID SATA+SAS RAID controllers that address the needs for both internal and external solutions. The MegaRAID 6Gb/s SAS RAID controllers are based on the LSI first-to-market SAS IC technology and proven MegaRAID technology. As second-generation PCIe RAID controllers, these controllers address the growing demand for increased data throughput and scalability requirements across midrange and enterprise-class server platforms. These controllers provide these features:

- 6Gb/s Serial Attached SCSI (SAS) performance
- 6Gb/s SATA III performance
- Eight-lane, 5 GT/s PCIe host interface

#### 1.1.1 MegaRAID SATA+SAS Controllers with Disk Encryption Support

The MegaRAID SAS 9260DE-8i RAID controller and the MegaRAID SAS 9280DE-8i RAID controller offer data security using disk encryption. This feature offers the ability to encrypt data on drives and use disk-based key management to provide data security. This solution provides data protection in the event of theft or loss of physical drives. With self-encrypting drives, if you remove a drive from its storage system or the server in which it is housed, the data on that drive is encrypted and is useless to anyone who attempts to access without the appropriate security authorization.

For more information about self-encrypting drives, refer to the *MegaRAID SAS Software User Guide* on the *MegaRAID Universal Software Suite* CD.

---

## 1.1.2 MegaRAID SATA+SAS Controllers with Support for Battery Backup Units and CacheVault Modules

Some MegaRAID SATA+SAS RAID controllers can use optional cache products, which include a battery backup unit (iBBU) or a CacheVault® Flash Module (CVFM), to protect cached data even during the most catastrophic system failures.

The following MegaRAID SATA+SAS RAID controllers can use a CacheVault Flash Module (CVFM) with a CacheVault Power Module (CVPM) to protect cached data in case of a power failure or outage:

- MegaRAID SAS 9260CV-4i
- MegaRAID SAS 9260CV-8i
- MegaRAID SAS 9265CV-8i
- MegaRAID SAS 9266-4i
- MegaRAID SAS 9266-8i
- MegaRAID SAS 9271-4i
- MegaRAID SAS 9271-8i
- MegaRAID SAS 9271-8iCC
- MegaRAID SAS 9285CV-8e
- MegaRAID SAS 9286CV-8e
- MegaRAID SAS 9286CV-8eCC

Refer to the *Cache Backup Products for MegaRAID SAS RAID Controllers User Guide*, the *MegaRAID CacheVault Power Module 02 Quick Installation Guide*, the battery backup unit quick installation guides, and the RAID controller quick installation guides on the *MegaRAID Universal Software Suite* CD for more information about the battery backup units and the CacheVault modules.

## 1.1.3 SAS/SATA Standards and Communication Protocols

MegaRAID SATA+SAS controllers support the ANSI® *Serial Attached SCSI standard, version 2.0*. In addition, the controller supports the SATA III protocol defined by the *Serial ATA specification, version 3.0*. Supporting both the SAS interface and the SATA interface, the SAS controller is a versatile controller that provides the backbone of both server and high-end workstation environments.

Each port on your MegaRAID SAS RAID controller supports SAS devices, SATA devices, or both, by using the following protocols:

- SAS Serial SCSI Protocol (SSP), which enables communication with other SAS devices
- SATA, which enables communication with other SATA devices
- Serial Management Protocol (SMP), which communicates topology management information directly with an attached SAS expander device
- Serial Tunneling Protocol (STP), which enables communication with SATA devices through an attached expander

## 1.2 General Description

The MegaRAID 6Gb/s SAS RAID controllers bring 6Gb/s Serial Attached SCSI and 6Gb/s SATA III performance to host adapter, workstation, and server designs. The controllers support internal storage devices and external storage devices, which allow you to use a system that supports enterprise-class SAS drives and desktop-class SATA III drives. Each MegaRAID 6Gb/s SAS RAID controller can connect to drives directly and can use expanders to connect to additional drives. Simplified cabling between devices is an additional benefit.

These MegaRAID SATA+SAS RAID controllers are based on the following chips and devices:

- LSISAS2008 PCIe-SAS/SATA I/O Processor chip
- LSISAS2108 RAID On-a-Chip (ROC) device
- LSISAS2208 RAID On-a-Chip (ROC) device

These devices are compliant with the Fusion-MPT™ architecture and provides a PCIe x8 interface. Each port on the MegaRAID SAS controllers supports SAS devices, SATA devices, or both, using SSP, SMP, STP, and SATA. The SSP protocol enables the MegaRAID SAS controllers to communicate with other SAS devices. The SATA protocol enables the MegaRAID SAS controllers to communicate with SATA devices.

**NOTE** All of these RAID controllers provide an x8 PCIe 2.0 or x8 PCIe 3.0 interface.

## 1.3 6Gb/s MegaRAID SATA+SAS RAID Controller Detailed Descriptions

The 6Gb/s MegaRAID SATA+SAS RAID controllers are described in detail in the following subsections.

### 1.3.1 MegaRAID SAS 9240 RAID Controllers

- The MegaRAID SAS 9240-4i PCIe 2.0 Low-Profile Serial-Attached SCSI/SATA Disk Array Controller is a PCIe 2.0, half-size, full-height RAID controller based on the LSISAS2008 PCIe-SAS/SATA I/O Processor chip. The MegaRAID SAS 9240-4i controller controls four internal 6-Gb/s SAS/SATA ports through one SFF-8087 x4 internal mini SAS connector.
- The MegaRAID SAS 9240-8i PCIe 2.0 Low-Profile Serial-Attached SCSI/SATA Disk Array Controller is a PCIe 2.0, half-size, full-height RAID controller based on the LSISAS2008 PCIe-SAS/SATA I/O Processor chip. The MegaRAID SAS 9240-8i controller controls eight internal 6-Gb/s SAS/SATA ports through two SFF-8087 x4 internal mini SAS connectors.

### 1.3.2 MegaRAID SAS 9260 RAID Controllers

- The 6Gb/s MegaRAID SAS 9260-4i PCIe 2.0 Low-Profile Serial-Attached SCSI/SATA Disk Array Controller controls four internal SAS/SATA ports through one SFF-8087 x4 internal mini SAS connector.
- The 6Gb/s MegaRAID SAS 9260-8i PCIe 2.0 Low-Profile Serial-Attached SCSI/SATA Disk Array Controller controls eight internal SAS/SATA ports through two SFF-8087 x4 internal mini SAS connectors.
- The 6Gb/s MegaRAID SAS 9260-16i PCIe 2.0 Standard-Height Serial-Attached SCSI/SATA Disk Array Controller controls 16 internal SAS/SATA ports through four SFF-8087 x4 internal mini SAS connectors.
- The 6Gb/s MegaRAID SAS 9260CV-4i PCIe 2.0 Low-Profile Serial-Attached SCSI/SATA Disk Array Controller controls four internal SAS/SATA ports through one SFF-8087 x4 internal mini SAS connector, and it has an onboard CacheVault Flash Module 01 (CVFM01) that connects to a remote CacheVault Power Module 01.

- The 6Gb/s MegaRAID SAS 9260CV-8i PCIe 2.0 Low-Profile Serial-Attached SCSI/SATA Disk Array Controller controls eight internal SAS/SATA ports through two SFF-8087 x4 internal mini SAS connectors, and it has an onboard CacheVault Flash Module 01 (CVFM01) that connects to a remote CacheVault Power Module 01.
- The 6Gb/s MegaRAID SAS 9260DE-8i PCIe 2.0 Low-Profile Serial-Attached SCSI/SATA Disk Array Controller controls eight internal SAS/SATA ports through two SFF-8087 x4 internal mini SAS connectors and offers data security using disk encryption.

### 1.3.3 MegaRAID SAS 9261 RAID Controller

The 6Gb/s MegaRAID SAS 9261-8i PCIe 2.0 Low-Profile Serial-Attached SCSI/SATA Disk Array Controller controls eight internal SAS/SATA ports through two SFF-8087 mini-SAS 4i internal connectors.

### 1.3.4 MegaRAID SAS 9265 RAID Controllers

- The 6Gb/s MegaRAID SAS 9265-8i PCIe 2.0 Low-Profile Serial-Attached SCSI/SATA Disk Array Controller controls eight internal SAS/SATA ports through two SFF-8087 x4 mini internal SAS connectors.
- The 6Gb/s MegaRAID SAS 9265CV-8i PCIe 2.0 Serial-Attached SCSI/SATA Disk Array Controller controls eight internal SAS+SATA ports through two SFF-8087 mini-SAS 4i internal connectors, and it has an onboard CacheVault Flash Module 03 (CVFM03) that connects to a remote CacheVault Power Module 02 (CVPM02).

### 1.3.5 MegaRAID SAS 9266 RAID Controllers

- The 6Gb/s MegaRAID SAS 9266-4i PCIe 2.0 Low-Profile Serial-Attached SCSI/SATA Disk Array Controller controls four internal SAS+SATA ports through one SFF-8087 mini SAS 4i internal connector.
- The 6Gb/s MegaRAID SAS 9266-8i PCIe 2.0 Low-Profile Serial-Attached SCSI/SATA Disk Array Controller controls eight internal SAS+SATA ports through two SFF-8087 mini SAS 4i internal connectors, and it has an on-board CacheVault Flash Module 02 (CVFM02) that connects to a remote CacheVault Power Module 02 (CVPM02).

### 1.3.6 MegaRAID SAS 9270 RAID Controller

The 6Gb/s MegaRAID SAS 9270-8i PCIe 3.0 Low-Profile Serial-Attached SCSI/SATA Disk Array Controller controls eight internal SAS/SATA ports through two SFF-8087 mini-SAS 4i internal connectors.

### 1.3.7 MegaRAID SAS 9271 RAID Controllers

The 6Gb/s MegaRAID SAS 9271-4i PCIe 3.0 Low-Profile Serial-Attached SCSI/SATA Disk Array Controller controls four internal SAS/SATA ports through one SFF-8087 mini-SAS 4i internal connector.

The 6Gb/s MegaRAID SAS 9271-8i PCIe 3.0 Low-Profile Serial-Attached SCSI/SATA Disk Array Controller controls eight internal SAS/SATA ports through two SFF-8087 mini-SAS 4i internal connectors.

The 6Gb/s MegaRAID SAS 9271-8iCC PCIe 3.0 Low-Profile Serial-Attached SCSI/SATA Disk Array Controller controls eight internal SAS/SATA ports through two SFF-8087 mini-SAS 4i internal connectors. This RAID controller supports CacheCade® Pro 2.0 and Fast Path software enabled out of the box, which optimize application performance in direct-attached storage environments configured with solid-state drives (SSDs).



### 1.3.8 MegaRAID SAS 9280 RAID Controllers

- The 6Gb/s MegaRAID SAS 9280-4i4e PCIe 2.0 Low-Profile Serial-Attached SCSI/SATA Disk Array Controller controls four internal SAS/SATA ports through one SFF-8087 x4 internal mini SAS connector and four external SAS/SATA ports through one SFF-8088 x4 external mini SAS connector.
- The 6Gb/s MegaRAID SAS 9280-8e PCIe 2.0 Low-Profile Serial-Attached SCSI/SATA Disk Array Controller controls eight external SAS/SATA ports through two SFF-8088 x4 external mini SAS connectors.
- The 6Gb/s MegaRAID SAS 9280DE-8e PCIe 2.0 Low-Profile Serial-Attached SCSI/SATA Disk Array Controller controls eight external SAS/SATA ports through two SFF-8088 x4 external mini SAS connectors and offers data security using disk encryption.
- The 6Gb/s MegaRAID SAS 9280-16i4e PCIe 2.0 Standard-Height Serial-Attached SCSI/SATA Disk Array Controller controls 16 internal SAS/SATA ports through four SFF-8087 x4 internal mini SAS connectors and four external SAS/SATA ports through one SFF-8088 x4 external mini SAS connector.
- The 6Gb/s MegaRAID SAS 9280-24i4e PCIe 2.0 Standard-Height Serial-Attached SCSI/SATA Disk Array Controller controls 24 internal SAS/SATA ports through six SFF-8087 x4 internal mini SAS connectors and four external SAS/SATA ports through one SFF-8088 x4 external mini SAS connector.

### 1.3.9 MegaRAID SAS 9285 RAID Controllers

- The 6Gb/s MegaRAID SAS 9285-8e PCIe 2.0 Low-Profile Serial-Attached SCSI/SATA Disk Array Controller controls eight external SAS/SATA ports through two SFF-8088 x4 external mini SAS connectors.
- The 6Gb/s MegaRAID SAS 9285CV-8e PCIe 2.0 Low-Profile Serial-Attached SCSI/SATA Disk Array Controller controls eight external SAS/SATA ports through two SFF-8088 x4 external mini SAS connectors, and it has an onboard CacheVault Flash Module 03 (CVFM03) that connects to a remote CacheVault Power Module 02 (CVPM02).

### 1.3.10 MegaRAID SAS 9286 RAID Controllers

- The 6Gb/s MegaRAID SAS 9286-8e PCIe 3.0 Low-Profile Serial-Attached SCSI/SATA Disk Array Controller controls eight external SAS/SATA ports through two SFF-8088 x4 external mini SAS connectors.
- The 6Gb/s MegaRAID SAS 9286CV-8e PCIe 3.0 Low-Profile Serial-Attached SCSI/SATA Disk Array Controller controls eight internal SAS/SATA ports through two SFF-8088 x4 mini external SAS connectors. This RAID controller supports the CVFM03 module, which connects to a remote CacheVault Power Module 02.
- The 6Gb/s MegaRAID SAS 9286CV-8eCC PCIe 3.0 Low-Profile Serial-Attached SCSI/SATA Disk Array Controller controls eight internal SAS/SATA ports through two SFF-8088 x4 mini external SAS connectors. This RAID controller supports the CVFM03 module, which connects to a remote CacheVault Power Module 02. In addition, this controller supports CacheCade Pro 2.0 and Fast Path software enabled out of the box, which optimize application performance in direct-attached storage environments configured with solid-state drives (SSDs).

## 1.4 Configuration Scenarios

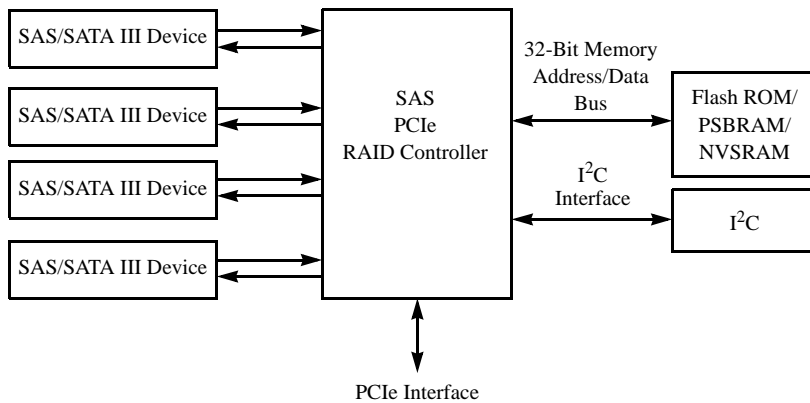
You can use the MegaRAID SAS RAID controllers in three main scenarios:

- **Low-end, internal SATA configuration:** In this configuration, use the RAID controller as a high-end SATA, SATA II, or SATA III compatible controller that connects up to eight drives either directly or through a port expander. This configuration is mostly for low-end or entry servers. An out-of-band I<sup>2</sup>C bus provides enclosure management. Side bands of both types of internal SAS connectors support the SFF-8485 (SGPIO) interface.
- **Midrange internal SAS configuration:** This configuration is like an internal SATA configuration, but with high-end SAS drives. This configuration is more suitable for low-range to midrange servers.

- **High-end external SAS/SATA configuration:** This configuration is for external connectivity using SATA drives, SATA II drives, SATA III drives, SAS drives, or combinations of SATA and SAS drives. External enclosure management is supported through in-band, SCSI-enclosed storage. The configuration must support STP and SMP.

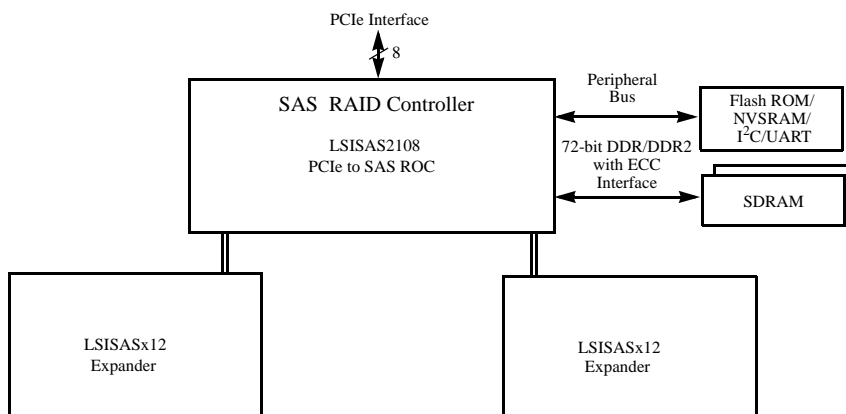
The following figure shows a direct-connect configuration. The Inter-IC (I<sup>2</sup>C) interface communicates with peripherals. The external memory bus provides a 32-bit memory bus, parity checking, and chip select signals for pipelined synchronous burst static random access memory (PSBRAM), nonvolatile static random access memory (NVSRAM), and Flash ROM.

**Figure 1 Example of an LSI SAS Direct-Connect Application**



The following figure shows an example of a SAS RAID controller configured with an LSI SASx12 expander that is connected to SAS drives, SATA III drives, or both.

**Figure 2 Example of an LSI SAS RAID Controller Configured with an LSI SASx12 Expander**



## 1.5 Benefits of the SAS Interface

SAS is a serial, point-to-point, enterprise-level device interface that leverages the proven SCSI protocol set. SAS is a convergence of the advantages of SATA, SCSI, and Fibre Channel, and it is the future mainstay of the enterprise and high-end workstation storage markets. SAS offers a higher bandwidth per pin than parallel SCSI, and it improves signal and data integrity.

The SAS interface uses the proven SCSI command set to ensure reliable data transfers, while providing the connectivity and flexibility of point-to-point serial data transfers. The serial transmission of SCSI commands eliminates clock-skew challenges. The SAS interface provides improved performance, simplified cabling, smaller connectors, lower pin count, and lower power requirements when compared to parallel SCSI.

SAS controllers leverage a common electrical and physical connection interface that is compatible with Serial ATA technology. The SAS protocols and the SATA III protocols use a thin, 7-wire connector instead of the 68-wire SCSI cable or 26-wire ATA cable. The SAS/SATA III connector and cable are easier to manipulate, allow connections to smaller devices, and do not inhibit airflow. The point-to-point SATA III architecture eliminates inherent difficulties created by the legacy ATA master-slave architecture, while maintaining compatibility with existing ATA firmware.

### 1.5.1 PCIe Architecture

PCIe is a local bus system designed to increase data transfers without slowing down the central processing unit (CPU). You can install MegaRAID PCIe RAID controllers in PCIe computer systems with a standard bracket type. With these controllers in your system, you can connect SAS devices and SATA III devices over the bus.

**NOTE** This controller is a PCIe x8 card, and it can operate in x8 or x16 slots. Some PCIe slots, however, support only PCIe graphics cards; if the remote mount board is installed in one of these slots, the controller will not function. Refer to the guide for your motherboard for information about the PCIe slot.

PCIe goes beyond the PCI specification in that it is intended as a unifying I/O architecture for various systems: desktops, workstations, mobile devices, servers, communications, and embedded devices.

### 1.5.2 Operating System Support

The MegaRAID 6Gb/s SAS RAID controllers support the following operating systems:

- Windows® 2000, Windows XP, Windows XP x64, Windows Server® 2003 (x86), Windows Server 2003 (x64), Windows Vista®, Windows Server 2008, and Windows Server 2012
- Red Hat® Linux®
- SuSE® SLES
- Novell® NetWare®
- SCO® OpenServer®
- SCO UnixWare®
- Solaris®
- FreeBSD®
- VMware®

Refer to the *MegaRAID SAS Device Driver Installation User Guide* for more information about the drivers. To download the latest operating system drivers, go to: <http://www.lsi.com/cm/DownloadSearch.do>.

The MegaRAID 6Gb/s SAS RAID controllers use Fusion-MPT architecture for all major operating systems, thinner drivers, and better performance.

## 1.6 Summary of 6Gb/s MegaRAID SATA+SAS RAID Controller Characteristics

This section summarizes the features and benefits offered by the MegaRAID 6Gb/s SAS RAID controllers. It contains information on SAS features, SATA features, PCI performance, integration, usability, and flexibility.

The MegaRAID 6Gb/s SAS RAID controllers have the following features:

- PCIe x8 lane width (with support for x16 connections)
- PCIe performance up to 5GT/s (4Gb/s) per lane
- Support for a 512-MB DDR2 800-MHz onboard SDRAM for LSISAS2108-based controllers
- Support for a 1-GB DDR3 1333-MT/s onboard SDRAM for LSISAS2208-based controllers
- One internal connector for the MegaRAID SAS 9240-4i, SAS 9260-4i, SAS 9260CV-4i, SAS 9266-4i, SAS 9271-4i, and SAS 9280-4i4e RAID controllers
- Two internal connectors for the MegaRAID SAS 9240-8i, SAS 9260-8i, SAS 9260CV-8i, SAS 9260DE-8i, SAS 9261-8i, SAS 9265CV-8i, SAS 9265-8i, SAS 9266-8i, SAS 9270-8i, and SAS 9271-8i RAID controllers
- Four internal connectors for the MegaRAID SAS 9260-16i and SAS 9280-16i4e RAID controllers
- Six internal connectors for the MegaRAID SAS 9280-24i4e RAID controller
- One external connector for the MegaRAID SAS 9280-4i4e, SAS 9280-16i4e, and SAS 9280-24i4e RAID controllers
- Two external connectors for the MegaRAID SAS 9280-8e, SAS 9280DE-8e, SAS 9285-8e, SAS 9285CV-8e, SAS 9285DE-8e, SAS 9286-8e, SAS 9286CV-8e, SAS 9286CV-8eCC RAID controllers
- Support for RAID levels 0, 1, 5, 6, 10, 50, and 60
- Advanced array configuration and management utilities
- Support for global hot spares and dedicated hot spares
- Support for user-defined strip sizes: 8, 16, 32, 64, 128, 256, 512, or 1024 KB

### NOTE

RAID 0, 1, and 10 configurations for MegaRAID SAS 9240 RAID controllers are limited to 16 drives and 64K stripe size. To exceed these limitations, you can plug in a new MegaRAID SAS 9260 RAID controller or a new MegaRAID SAS 9280 RAID controller. The MegaRAID Storage Manager™ utility recognizes and imports the existing array with no reconfiguration required.

- Advanced array configuration and management utilities offer these capabilities:
  - Online capacity expansion to add space to an existing drive or a new drive
  - Online RAID level migration
  - Drive migration
  - Drive roaming
  - No reboot necessary after expansion
  - Load balancing
  - Media scan
- User-specified rebuild rate (specifying the percentage of system resources to use from 0 percent to 100 percent)
- Nonvolatile random access memory (NVRAM) of 32 KB for storing RAID system configuration information; the MegaRAID SAS firmware is stored in flash ROM for easy upgrade.

## 1.6.1 SAS Features

The MegaRAID 6Gb/s SAS RAID controllers support the following SAS features:

- Four fully independent PHYs or eight fully independent PHYs, depending on the controller.
- Support of 6Gb/s and 3Gb/s SAS data transfers per PHY.
- Support of SMP to communicate topology-management information.
- Support of SSP to enable communication with other SAS devices.
- Support of STP to enable communication with SATA devices through an attached expander.
- Serial, point-to-point, enterprise-level storage interface.
- Simplified cabling between devices.
- Scalable interface that supports up to 240 devices through the use of expanders

**NOTE** The number of devices varies depending on the controller. Check the LSI website (<http://www.lsi.com>) for details about your product.

- Support of wide ports that consist of two, three, or four PHYs within a single quad port.
- Support of narrow ports consisting of a single PHY.
- Data transfer using SCSI information units.

## 1.6.2 SAS Array Limitations

This section describes the array limitations of the MegaRAID 6Gb/s SAS RAID controllers. These limitations include the number of drives supported per controller, the maximum number of drives per controller, and the maximum number of virtual drives allowed per controller.

The following table lists the array limitations for the MegaRAID 6Gb/s SAS RAID controllers.

**Table 1 6Gb/s MegaRAID SATA+SAS RAID Controllers Array Limitations**

Specification	SAS 9240-4i	SAS 9240-8i	SAS 9260-4i SAS 9260CV-4i	SAS 9260-8i SAS 9260CV-8i	SAS 9260-16i	SAS 9261-8i	SAS 9265-8i SAS 9265CV-8i SAS 9265-8i	SAS 9266-4i SAS 9271-4i	SAS 9266-8i SAS 9271-8i	SAS 9280 4i4e	SAS 9280-8e	SAS 9280DE-8e	SAS 9280-16i4e	SAS 9280-24i4e	SAS 9285-8e SAS 9285CV-8e SAS 9286-8e SAS 9286CV-8e
Maximum virtual drives per controller	16	16	64	64	64	64	64	64	64	64	64	64	64	64	64
Maximum drive groups per controller	16	16	128	128	128	128	128	128	128	128	128	128	128	128	128
Maximum virtual drives per drive group	16	16	16	16	16	16	16	16	16	16	16	16	16	16	16
Maximum drives per drive group	16	16	32	32	32	32	32	32	32	32	32	32	32	32	32
Maximum drives per controller	16 <sup>a</sup>	16 <sup>a</sup>	128	128	128	128	128	128	128	128	240	240	240	240	240
Maximum hot spares per controller	16 <sup>a</sup>	16 <sup>a</sup>	128	128	128	128	128	128	128	128	240	240	240	240	240
Maximum spans per virtual drive	8	8	8	8	8	8	8	8	8	8	8	8	8	8	8
Maximum enclosures per port <sup>b</sup>	2	2	2	2	10	2	2	2	2	10	10	2	10	10	10
Number of port connectors	1	2	1	2	4	2	2	1	2	2	2	2	5	7	2

a. These controllers can support up to 64 devices, but only 16 can be used in a RAID configuration.

b. The number assumes one storage enclosure processor (SEP) per enclosure.

The maximum numbers in the previous table depend on how many physical devices you have connected to the RAID controller. For example, the maximum number of drive groups is equal to the number of drives that are supported by the controller. Thus, for the MegaRAID SAS 9240-4i RAID controller, the maximum number of drive groups per controller is 16, which is based on the maximum number of physical devices that you can connect. In addition, the maximum number of hot spares per controller is equal to the maximum number of drives per controller.

Although you can have up to 16 virtual drives per drive group, and up to 128 drive groups on most of the controllers, a limit of 64 virtual drives exists on those controllers.

These RAID controllers support 64-bit logical block addressing (LBA), which makes it possible to connect a large number of drives to the RAID controller, directly and through expanders. However, the actual number of drives that you can attach depends on the limits listed in this table rather than by actual RAID volume capacity.

### 1.6.3 SATA III Features

The following list describes the SATA III features of the RAID controllers:

- They support SATA III data transfers of 3Gb/s (for LSI SAS2108-based controllers) and 6Gb/s (for LSI SAS2208-based controllers).
- They support STP data transfers of 3Gb/s.
- They provide a serial, point-to-point storage interface.
- They simplify cabling between devices.
- They eliminate the master-slave construction used in parallel ATA.
- They permit addressing of multiple SATA targets through an expander.
- They permit multiple initiators to address a single target (in a failover configuration) through an expander.

### 1.6.4 PCIe Performance

The following list describes the PCIe performance features of the RAID controllers:

- They provide a PCIe interface that does the following:
  - Supports a dedicated PCIe bus.
  - Supports x8 lane configuration.
  - Supports transfer rates of up to 5GT/s (4Gb/s) per lane.
  - Complies with the *PCI Express specification, Revision 2.0*, and the *Serial ATA specification, version 3.0*.
- They provide unequalled performance through the Fusion-MPT architecture.
- They provide high throughput and low CPU utilization to offload the host processor.

### 1.6.5 Usability Features

The following list describes the usability features of the RAID controllers:

- They simplify cabling with point-to-point, serial architecture.
- They support smaller, thinner cables that do not restrict airflow.
- They provide drive spin-up sequencing control.
- They provide one LED signal for each PHY to indicate link activity (this is a fault LED only for controllers with internal port connectors).

**NOTE** The MegaRAID SAS 9280-8e RAID controller and the MegaRAID SAS 9280DE-8e RAID controller do not have LEDs to indicate link activity.

- They provide an I<sup>2</sup>C interface for enclosure management.
- They support the internal SAS Sideband signal SFF-8485 (SGPIO) interface.

### 1.6.6 Flexibility Features

These features increase the flexibility of the RAID controllers:

- They support a Flash ROM interface, a nonvolatile static RAM (NVS RAM) interface, and a pipelined synchronous burst SRAM (PSBRAM) interface.
- They offer a flexible programming interface to tune I/O performance.
- They permit mixed connections to SAS targets or SATA III targets.
- They leverage compatible connectors for SAS connections and SATA III connections.
- They permit grouping of up to four PHYs in a single quad port to form a wide port.
- They permit programming of the World Wide Name.

### 1.6.7 Drive Roaming

Drive roaming occurs when the drives are changed to different ports on the same controller. When the drives are placed on different channels, the controller detects the RAID configuration from the configuration data on the drives.

Configuration data is saved in both the NVRAM on the RAID controller and on the drives attached to the controller. This action maintains the integrity of the data on each drive, even if the drives have changed their physical device ID.

**NOTE** If you move a drive that is being rebuilt, the rebuild operation restarts; it does not resume from the stopping point.

Follow these steps to use the drive roaming feature:

1. Turn off the power to the server and all drives, enclosures, and system components. Disconnect the power cords from the system.
2. Open the host system by following the instructions in the host system technical documentation.
3. Move the drives to different positions on the backplane to change the targets.
4. Determine the SAS target requirements.
5. Perform a safety check.
  - a. Make sure that the drives are inserted correctly.
  - b. Close the cabinet of the host system.
6. Reconnect the power cords to the system.
7. Turn on the power to the system.

The controller then detects the RAID configuration from the configuration data on the drives.

### 1.6.8 Drive Migration

Drive migration is the transfer of a set of drives in an existing configuration from one controller to another. The drives must remain on the same channel and must be reinstalled in the same order as in the original configuration. The controller to which you migrate the drives cannot have an existing configuration.

**NOTE** Partial configurations, which include individual virtual drives, can be migrated.

**NOTE** Drive roaming and drive migration cannot be supported at the same time.

Follow these steps to migrate drives:

1. Make sure that you clear the configuration on the system to which you migrate the drives to prevent a configuration data mismatch between the drives and the NVRAM.

**NOTE** When you migrate drives, move only the drives that make up the virtual drive (not all of the drives in a drive group), so that you do not see an NVRAM mismatch error (providing a configuration is on the destination controller). The NVRAM mismatch error appears only if you move all of the drives to the other controller.

2. Turn off power to the server and all drives, enclosures, and system components. Disconnect the power cords from the systems.
3. Open the host system by following the instructions in the host system technical documentation.
4. Either remove the SAS cable connectors from the internal drives, or remove the shielded cables from the external drives that you want to migrate.
  - a. Make sure that pin 1 on the cable matches pin 1 on the connector.
  - b. Make sure that the SAS cables conform to all SAS specifications.
5. Remove the drives from the first system, and insert them into the drive bays on the second system.
6. Connect the SAS cables to the drives in the second system.
7. Determine the SAS target requirements.
8. Perform a safety check.
  - a. Make sure that all of the cables are attached correctly.
  - b. Make sure that the RAID controller is installed correctly.
  - c. Close the cabinet of the host system.
9. Reconnect the power cords to the system.
10. Turn on the power to the system.

The controller detects the RAID configuration from the configuration data on the drives.

## 1.7 Hardware Specifications

You can install the MegaRAID 6Gb/s SAS RAID controllers in a computer with a motherboard that has a PCIe slot. The following table describes the hardware configuration features for the MegaRAID 6Gb/s SAS RAID controllers.

**Table 2 6Gb/s MegaRAID SATA+SAS RAID Controller Features**

Specification	MegaRAID SAS 9240, SAS 9260, SAS 9261, SAS 9265, SAS 9266, SAS 9270, SAS 9271, SAS 9280, SAS 9285, and SAS 9286 RAID Controllers
RAID levels	0, 1, 5, 6, 10, 50, 60  <b>NOTE</b> The MegaRAID SAS 9240-4i RAID controller and the MegaRAID SAS 9240-8i RAID controller do not support RAID 6 or RAID 60.
Devices supported per port	Up to 15 SAS devices or SATA III devices (such as drives and expanders)
Number of ports	<ul style="list-style-type: none"> <li>■ MegaRAID SAS 9240-4i RAID controller – Four ports through one SFF-8087 x4 internal mini SAS connector</li> <li>■ MegaRAID SAS 9240-8i RAID controller – Eight ports through two SFF-8087 x4 internal mini SAS connectors</li> <li>■ MegaRAID SAS 9260-4i RAID controller – Four ports through one SFF-8087 x4 internal mini SAS connector</li> </ul>



**Table 2 6Gb/s MegaRAID SATA+SAS RAID Controller Features (Continued)**

Specification	MegaRAID SAS 9240, SAS 9260, SAS 9261, SAS 9265, SAS 9266, SAS 9270, SAS 9271, SAS 9280, SAS 9285, and SAS 9286 RAID Controllers
Number of ports (continued)	<ul style="list-style-type: none"> <li>■ MegaRAID SAS 9260-8i RAID controller – Eight ports through two SFF-8087 x4 internal mini SAS connectors</li> <li>■ MegaRAID SAS 9260CV-4i RAID controller – Four ports through one SFF-8087 x4 internal mini SAS connector</li> <li>■ MegaRAID SAS 9260CV-8i RAID controller – Eight ports through two SFF-8087 x4 internal mini SAS connectors</li> <li>■ MegaRAID SAS 9260DE-8i RAID controller – Eight ports through two SFF-8087 x4 internal mini SAS connectors</li> <li>■ MegaRAID SAS 9260-16i RAID controller – Sixteen ports through four SFF-8087 x4 internal mini SAS connectors</li> <li>■ MegaRAID SAS 9261-8i RAID controller – Eight ports through two SFF-8087 mini-SAS 4i connectors</li> <li>■ MegaRAID SAS 9265-8i RAID controller – Eight ports through two SFF-8087 x4 internal mini SAS connectors</li> <li>■ MegaRAID SAS 9265CV-8i RAID controller – Eight ports through two SFF-8087 x4 internal mini SAS connectors</li> <li>■ MegaRAID SAS 9266-4i RAID controller – Four ports through one SFF-8087 mini SAS 4i internal connector</li> <li>■ MegaRAID SAS 9266-8i RAID controller – Eight ports through two SFF-8087 mini SAS 4i internal connectors</li> <li>■ MegaRAID SAS 9270-8i RAID controller – Eight ports through two SFF-8087 mini SAS 4i internal connectors</li> <li>■ MegaRAID SAS 9271-4i RAID controller – Four ports through one SFF-8087 mini-SAS 4i internal connector</li> <li>■ MegaRAID SAS 9271-8i RAID controller – Eight internal SAS/SATA ports through two SFF-8087 mini-SAS 4i internal connectors</li> <li>■ MegaRAID SAS 9271-8iCC RAID controller – Eight internal SAS/SATA ports through two SFF-8087 mini-SAS 4i internal connectors</li> <li>■ MegaRAID SAS 9280-4i4e RAID controller – Four ports through one SFF-8087 x4 internal mini SAS connector and four ports through one SFF-8088 x4 external mini SAS connector</li> <li>■ MegaRAID SAS 9280-8e RAID controller – Eight ports through two SFF-8088 x4 external mini SAS connectors</li> <li>■ MegaRAID SAS 9280-16i4e RAID controller – Sixteen ports through four SFF-8087 x4 internal mini SAS connectors and four ports through one SFF-8088 x4 external mini SAS connector</li> <li>■ MegaRAID SAS 9280-24i4e RAID controller – Twenty-four ports through six SFF-8087 x4 internal mini SAS connectors and four ports through one SFF-8088 x4 external mini SAS connector</li> <li>■ MegaRAID SAS 9280DE-8e RAID controller – Eight ports through two SFF-8088 x4 external mini SAS connectors</li> <li>■ MegaRAID SAS 9285-8e RAID controller – Eight ports through two SFF-8088 x4 external mini SAS connectors</li> <li>■ MegaRAID SAS 9285CV-8e RAID controller – Eight ports through two SFF-8088 x4 external mini SAS connectors</li> <li>■ MegaRAID SAS 9286-8e RAID controller – Eight ports through two SFF-8088 x4 external mini SAS connectors</li> <li>■ MegaRAID SAS 9286CV-8e RAID controller – Eight internal SAS/SATA ports through two SFF-8088 x4 mini external SAS connectors</li> <li>■ MegaRAID SAS 9286CV-8eCC RAID controller – Eight internal SAS/SATA ports through two SFF-8088 x4 mini external SAS connectors</li> </ul>
Data transfer rate	Up to 6Gb/s per PHY

**Table 2 6Gb/s MegaRAID SATA+SAS RAID Controller Features (Continued)**

Specification	MegaRAID SAS 9240, SAS 9260, SAS 9261, SAS 9265, SAS 9266, SAS 9270, SAS 9271, SAS 9280, SAS 9285, and SAS 9286 RAID Controllers
Bus	<ul style="list-style-type: none"> <li>■ PCIe 2.0 (for LSI SAS2108-based controllers)</li> <li>■ PCIe 3.0 (for LSI SAS2208-based controllers)</li> </ul>
Cache function	<p>Write-back, write-through, non-read-ahead, read-ahead, cache I/O, direct I/O</p> <p><b>NOTE</b> The MegaRAID SAS 9240-4i RAID controller and the MegaRAID SAS 9240-8i RAID controller do not support write-back mode.</p>
Multiple virtual drives per controller	Up to 64 (this value is dependent on the firmware)
Online capacity expansion	Yes
Dedicated and global hot spares	Yes
Hot-swap devices supported	Yes
Non-drive devices supported	Yes
Mixed-capacity drives supported	Yes
Number of external connectors	<ul style="list-style-type: none"> <li>■ MegaRAID SAS 9280-4i4e RAID controller – One SFF-8088 x4 external mini SAS connector</li> <li>■ MegaRAID SAS 9280-8e RAID controller – Two SFF-8088 x4 external mini SAS connectors</li> <li>■ MegaRAID SAS 9280DE-8e RAID controller – Two SFF-8088 x4 external mini SAS connectors</li> <li>■ MegaRAID SAS 9280-16i4e RAID controller – One SFF-8088 x4 external mini SAS connector</li> <li>■ MegaRAID SAS 9280-24i4e RAID controller – One SFF-8088 x4 external mini SAS connector</li> <li>■ MegaRAID SAS 9285-8e RAID controller – Two SFF-8088 x4 external mini SAS connectors</li> <li>■ MegaRAID SAS 9285CV-8e RAID controller – Two SFF-8088 x4 external mini SAS connectors</li> <li>■ MegaRAID SAS 9286-8e RAID controller – Two SFF-8088 x4 external mini SAS connectors</li> <li>■ MegaRAID SAS 9286CV-8e RAID controller – Two SFF-8088 x4 mini external SAS connectors</li> <li>■ MegaRAID SAS 9286CV-8eCC RAID controller – Two SFF-8088 x4 mini external SAS connectors</li> </ul>
Number of internal connectors	<ul style="list-style-type: none"> <li>■ MegaRAID SAS 9240-4i RAID controller – One SFF-8087 x4 internal mini SAS connector</li> <li>■ MegaRAID SAS 9240-8i RAID controller – Two SFF-8087 x4 internal mini SAS connectors</li> <li>■ MegaRAID SAS 9260-4i RAID controller – One SFF-8087 x4 internal mini SAS connector</li> <li>■ MegaRAID SAS 9260-8i RAID controller – Two SFF-8087 x4 internal mini SAS connectors</li> <li>■ MegaRAID SAS 9260-16i RAID controller – Four SFF-8087 x4 internal mini SAS connectors</li> <li>■ MegaRAID SAS 9260CV-4i RAID controller – One SFF-8087 x4 internal mini SAS connector</li> <li>■ MegaRAID SAS 9260CV-8i RAID controller – Two SFF-8087 x4 internal mini SAS connectors</li> <li>■ MegaRAID SAS 9260DE-8i RAID controller – Two SFF-8087 x4 internal mini SAS connectors</li> <li>■ MegaRAID SAS 9261-8i RAID controller – Two SFF-8087 mini-SAS 4i connectors</li> <li>■ MegaRAID SAS 9265-8i RAID controller – Two SFF-8087 internal mini SAS 4i connectors</li> <li>■ MegaRAID SAS 9265CV-8i RAID controller – Two SFF-8087 internal mini SAS 4i connectors</li> <li>■ MegaRAID SAS 9266-4i RAID controller – One SFF-8087 internal mini SAS 4i connector</li> <li>■ MegaRAID SAS 9266-8i RAID controller – Two SFF-8087 internal mini SAS 4i connectors</li> <li>■ MegaRAID SAS 9270-8i RAID controller – Two SFF-8087 mini-SAS 4i internal connectors</li> <li>■ MegaRAID SAS 9271-4i RAID controller – One SFF-8087 mini-SAS 4i internal connector</li> <li>■ MegaRAID SAS 9271-8i RAID controller – Two SFF-8087 mini-SAS 4i internal connectors</li> <li>■ MegaRAID SAS 9271-8iCC RAID controller – Two SFF-8087 mini-SAS 4i internal connectors</li> <li>■ MegaRAID SAS 9280-4i4e RAID controller – One SFF-8087 x4 internal mini SAS connector</li> <li>■ MegaRAID SAS 9280-16i4e RAID controller – Four SFF-8087 x4 internal mini SAS connectors</li> <li>■ MegaRAID SAS 9280-24i4e RAID controller – Six SFF-8087 x4 internal mini SAS connectors</li> </ul>

**Table 2 6Gb/s MegaRAID SATA+SAS RAID Controller Features (Continued)**

Specification	MegaRAID SAS 9240, SAS 9260, SAS 9261, SAS 9265, SAS 9266, SAS 9270, SAS 9271, SAS 9280, SAS 9285, and SAS 9286 RAID Controllers
Hardware exclusive OR (XOR) assistance	Yes
Direct I/O	Yes
Architecture	Fusion-MPT

## 1.8 Technical Support

For assistance installing, configuring, or running your MegaRAID 6Gb/s SAS RAID controller, contact LSI Technical Support.

Click the following link to access the LSI Technical Support page for storage and board support:

<http://www.lsi.com/about/contact/pages/support.aspx>

From this page, you can email or call LSI Technical Support, or submit a new service request and view its status.

**NOTE** Record your controller serial number in a safe location in case you need to contact LSI.

### Documents and Downloads:

[http://www.lsi.com/support/Pages/downloads.aspx?k=\\*](http://www.lsi.com/support/Pages/downloads.aspx?k=*)

---

## Chapter 2: MegaRAID SAS Hardware Installation

### 2.1 Requirements

The following items are required to install a MegaRAID 6Gb/s SAS RAID controller:

- A MegaRAID SAS 92xx RAID controller
- A host system with an available x8 PCIe 2.0 slot

**NOTE** These controllers also work in PCIe first generation slots. The PCIe software is backward compatible with previous revisions of the PCI bus and the PCI-X bus.

- The *MegaRAID Universal Software Suite* CD, which contains the drivers and documentation
- The necessary internal cables, external cables, or both
- SAS drives or SATA drives

**NOTE** Make sure to use an uninterruptible power supply.

### 2.2 Quick Installation

The following steps quickly install your MegaRAID 6Gb/s SAS RAID controller. These steps are for experienced computer users or installers. [Section 2.3, Detailed Installation](#), contains the steps for all other users to follow.

1. Turn off the power to the system and all drives, enclosures, and system components, and disconnect the PC power cord.
2. Open the cabinet of the host system by following the instructions in the host system technical documentation.
3. Check the jumper settings to make sure that they are in the desired position. The jumpers are set at the factory, and you usually do not need to change them.

**NOTE** See [Chapter 3, MegaRAID SAS RAID Controller Characteristics](#), for detailed information about the jumpers and the connectors.

4. Install the MegaRAID 6Gb/s SAS RAID controller in the server, and connect SAS devices or SATA II devices to it. Make sure that the cables you use conform to all specifications.
5. Perform a safety check.
  - a. Make sure that all cables are attached correctly.
  - b. Make sure that the RAID controller is installed correctly.
  - c. Close the cabinet of the host system.
6. Reconnect the power cords to the system.
7. Turn on the power to the system.

Make sure that the power is turned on to any external drives before the power is turned on to the host computer. If the computer is powered up before these devices, the devices might not be recognized.

---

## 2.3 Detailed Installation

This section provides detailed instructions for installing your MegaRAID 6Gb/s SAS RAID controller.

1. Unpack the MegaRAID 6Gb/s SAS RAID controller.

Unpack and remove your RAID controller. Inspect it for damage. If it appears damaged, or if any of the following items are missing, contact your LSI Customer and Technical Support representative. The RAID controller is shipped with the following items:

- A CD that contains an electronic version of this user's guide, and other related documentation
- A license agreement
- Warranty information

2. Turn off the power to the system.

Turn off the power to the computer, and disconnect the AC power cord. Remove the computer cover. Refer to the system documentation for instructions. Before you install the controller, make sure that the computer is disconnected from the power and from any networks.

3. Review the RAID controller jumpers and connectors.

The jumpers are set at the factory, and you usually do not need to change them. See [Chapter 3, MegaRAID SAS RAID Controller Characteristics](#), for diagrams of the MegaRAID 6Gb/s SAS RAID controllers that show their jumpers and connectors.

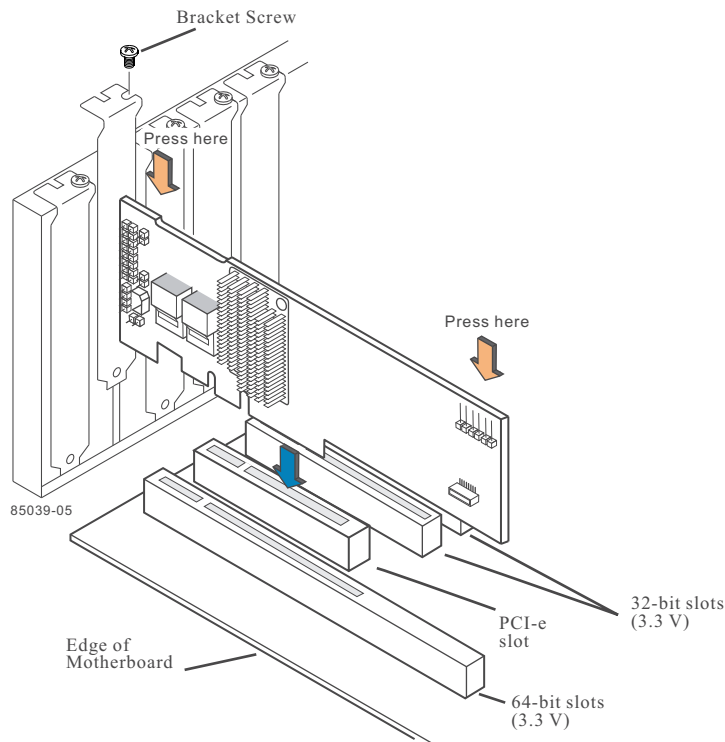
4. Install the RAID controller.

Select a PCIe slot, and align the controller's PCIe bus connector to the slot. Press down gently, but firmly, to make sure that the card is seated correctly in the slot. Secure the bracket to the computer chassis with the bracket screw. The following figure shows the installation of the MegaRAID SAS 9260-8i RAID controller in a PCIe slot.

**ATTENTION** If your RAID controller has a battery backup unit (BBU) attached, do not press down on the BBU when you insert the card.

**NOTE** This controller is a PCIe x8 card, and it can operate in x8 or x16 slots. Some PCIe slots, however, support only PCIe graphics cards; if the remote mount board is installed in one of these slots, the controller will not function. Refer to the guide for your motherboard for information about the PCIe slot.

**Figure 3 Example of the MegaRAID SAS 9260-8i Board Installation in a PCI Express Slot**



5. Configure and install the SAS devices, the SATA devices, or both in the host computer case. Refer to the documentation for the devices for any preinstallation configuration requirements.
6. Connect the RAID controller to the devices.  
Use SAS cables to connect SAS devices, SATA devices, or both to the MegaRAID 6Gb/s SAS RAID controller. See [Section 2.5, SAS Device Cables and Connectors](#), for SAS cable and connector information. See [Section 2.5.1, Connecting a SAS RAID Controller with Internal Connectors to the Drives](#), for information about connecting the controller to the drives.

The maximum cable length is 10 meters (393.37 in.). You can connect one device per SAS PHY unless you use an expander.

System throughput problems can occur if the SAS cables are not the correct type. To minimize the potential for problems, use the following guidelines:

- Use cables no longer than 10 meters (393.37 in.). (Use shorter cables, if possible.)
- Use cables that meet the SAS specification.
- Route the SAS cables carefully.

7. Turn on the power to the system.  
Reinstall the computer cover, and reconnect the AC power cords. Turn on power to the host computer. Make sure that the power is turned on to the SAS devices, SATA devices, or both before or at the same time that the power is turned on to the host computer. If the computer is powered on before these devices, the devices might not be recognized.  
During boot, a BIOS message appears. The firmware takes several seconds to initialize. The configuration utility prompt times out after several seconds. The second portion of the BIOS message shows the MegaRAID 6Gb/s SAS RAID controller number, firmware version, and cache SDRAM size. The numbering of the controllers follows the PCI slot scanning order used by the host motherboard.

8. Run the WebBIOS Configuration Utility.

Run the WebBIOS Configuration Utility to configure the drive groups and the virtual drives. When the message `Press CTRL+H for WebBIOS` appears on the screen, immediately press `Ctrl+H` to run the utility.

9. Install the operating system driver.

MegaRAID SAS RAID controllers can operate under various operating systems. To operate under these operating systems, you must install the software drivers. The *MegaRAID Universal Software Suite* CD includes software drivers for the supported operating systems, along with documentation. You can view the supported operating systems and download the latest drivers for RAID controllers from the LSI website.

For information about installing the driver, refer to the *MegaRAID SAS Device Driver Installation User Guide* on the *MegaRAID Universal Software Suite* CD. Be sure to use the latest service packs provided by the operating system manufacturer and to review the `readme` file that accompanies the driver.

## 2.4 After Installing the RAID Controller

After you install the MegaRAID 6Gb/s SAS RAID controller, you must configure the controller and install the operating system driver. The *MegaRAID SAS Software User Guide* instructs you on the configuration options and how to set them on your MegaRAID 6Gb/s SAS RAID controller. The *MegaRAID SAS Device Driver Installation User Guide* provides detailed installation instructions for operating system drivers.

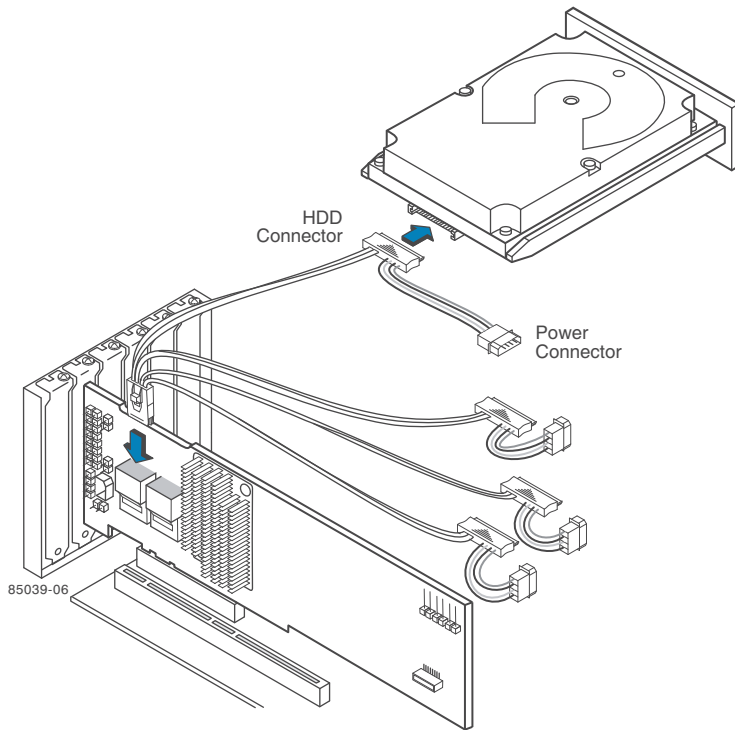
## 2.5 SAS Device Cables and Connectors

This section describes the cables and the connectors used on the MegaRAID SAS controllers and provides step-by-step instructions for connecting SAS drives, SATA drives, or both to the MegaRAID SAS RAID controller. The SAS protocol and the SATA protocol use a thin, 7-wire connector instead of the 68-wire SCSI cable or the 40-wire ATA cable.

**NOTE** Use only straight SAS cables, not crossover SAS cables.

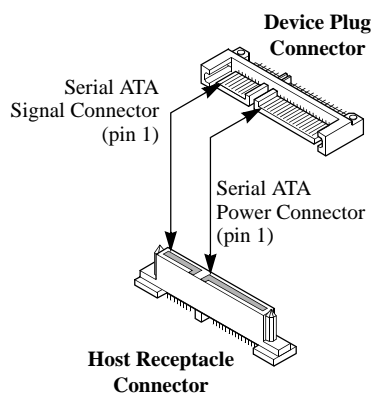
The following figure shows the SAS cable that connects the internal connectors on a SAS RAID controller to SAS drives, SATA drives, or both.

**Figure 4 Internal SAS Cable for Connection to SAS Drives, SATA II Drives, or SATA III Drives**



The following figure shows the SATA III device plug connector that connects a SAS RAID controller with internal connectors to the host receptacle connector on a backplane. A SATA III connector consists of a signal connector and a power connector.

**Figure 5 SATA III Connectors**

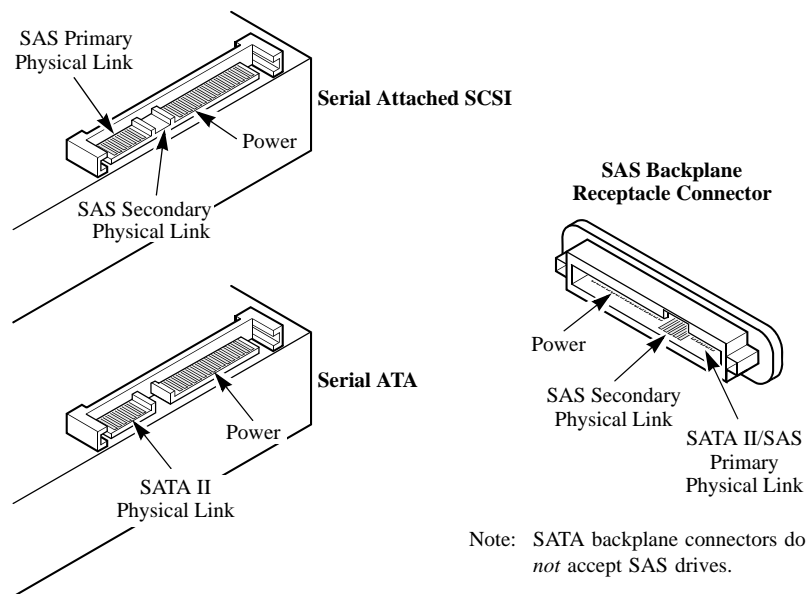


The following figure shows SAS connectors and SATA connectors on SAS drives and SATA drives, respectively. Cables connect internal connectors on the RAID controllers to connectors on SAS drives, SATA drives, or both. Both SAS drives and SATA drives can connect to SAS backplane receptacle connectors. The difference between the SAS connector and the SATA connector is the bridge between the SAS primary physical link and the power connector on the SAS controller, which the SATA connector does not have.

**NOTE** SAS backplane connectors accept SAS drives or SATA drives, but SATA backplane connectors *cannot* accept SAS drives.



**Figure 6 SAS Plugs and SATA Plugs and SAS Backplane Receptacle Connector**



The following subsections provide step-by-step instructions for connecting the MegaRAID SAS RAID controllers to SAS drives and SATA drives, either directly or through an expander.

### 2.5.1 Connecting a SAS RAID Controller with Internal Connectors to the Drives

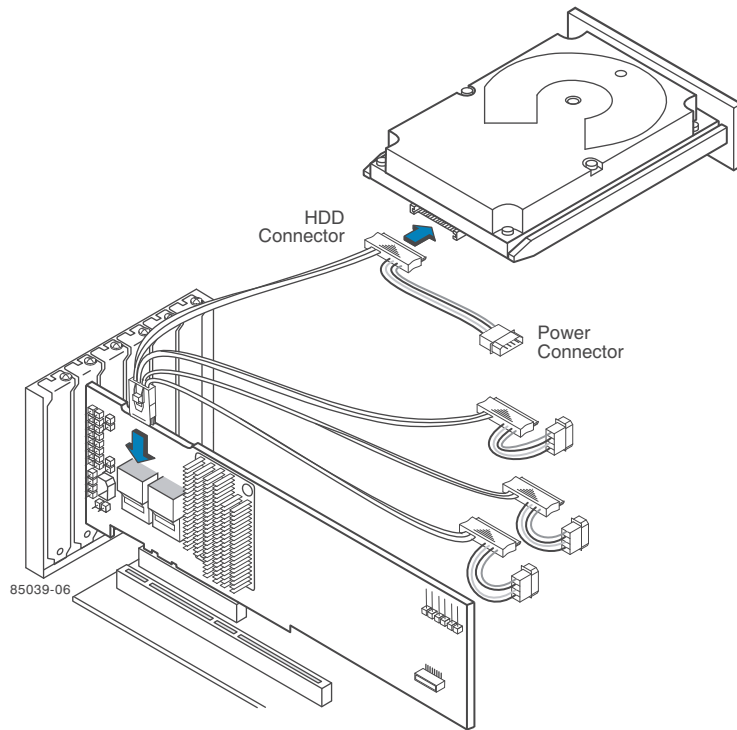
This section provides step-by-step instructions for connecting the SAS cable from the internal connectors on the RAID controller to SAS drives and SATA drives.

Follow these steps to connect your RAID controller with internal SAS port connectors directly to SAS drives or SATA drives.

**NOTE** The MegaRAID SAS 9260-8i RAID controller is shown as an example. You can connect other MegaRAID SAS controllers with internal SAS port connectors in the same way.

1. Insert the SFF-8087 x4 internal mini SAS connector on the cable into a SFF-8087 x4 internal mini SAS connector on the MegaRAID SAS 9260-8i RAID controller, as shown in the following figure.
2. Plug the HDD connector on the other end of the internal cable into the connector on the SAS drive or the SATA drive.
3. If you have another drive, connect it to another plug on the internal cable.  
You can connect other devices if the cable has more connectors.

**Figure 7 Connecting the MegaRAID SAS 9260-8i RAID Controller to a Drive**



## 2.5.2 Connecting a RAID Controller with External Connectors to a Drive Enclosure

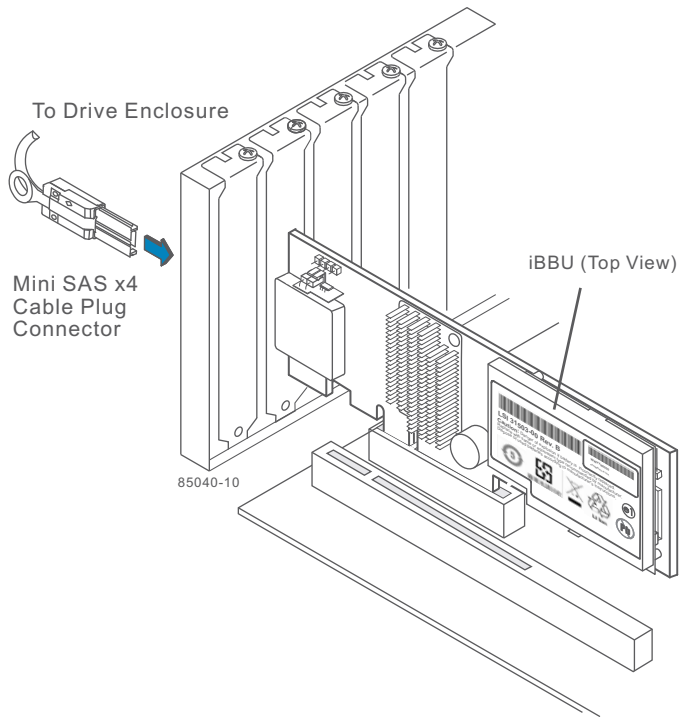
This section provides step-by-step instructions for connecting a MegaRAID SAS RAID controller with external SAS port connectors to a drive enclosure containing SAS drives, SATA drives, or a combination of both drive types.

Follow these steps to connect the cable from your controller to a drive enclosure.

**NOTE** The following figure shows the MegaRAID SAS 9280-8e RAID controller as an example. You can connect other MegaRAID SAS controllers with external SAS port connectors in the same way.

1. Connect the connector on one end of the cable to external port J1A4 or J1B1 on the MegaRAID SAS 9280-8e RAID controller, as shown in the following figure.
2. Connect the other end of the cable to the external port on the drive enclosure.

**Figure 8 Connecting the MegaRAID SAS 9280-8e RAID Controller to a Drive Enclosure**



## Chapter 3: MegaRAID SAS RAID Controller Characteristics

### 3.1 6Gb/s MegaRAID SAS RAID Controller Family

The 6Gb/s MegaRAID SAS RAID controllers are dual-PHY, SAS PCI Express RAID controllers and are used in a system with a PCI Express slot. PCIe goes beyond the PCI specification in that it is intended as a unifying I/O architecture for various systems: desktops, workstations, mobile devices, servers, communications, and embedded devices.

The following subsection provides figures and connector information for the 6Gb/s SAS RAID controllers.

#### 3.1.1 MegaRAID SAS 9240 RAID Controllers

The MegaRAID SAS 9240-4i low-profile SAS/SATA RAID controller controls four internal SAS/SATA ports through one SFF-8087 x4 internal mini SAS connector.

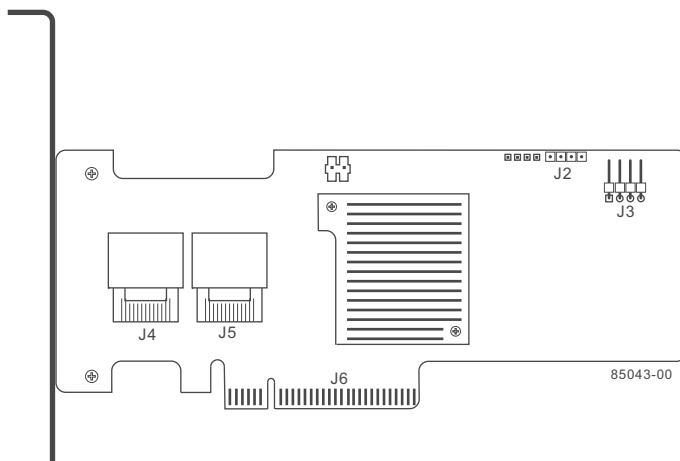
The MegaRAID SAS 9240-8i low-profile SAS/SATA RAID controller controls eight internal SAS/SATA ports through two SFF-8087 x4 internal mini SAS connectors.

##### 3.1.1.1 MegaRAID SAS 9240 RAID Controllers – Board Layout and Jumper and Connector Information

This subsection provides the board layout, and the connector and jumper information for the MegaRAID SAS 9240 RAID controllers. The following figure shows the jumpers and the connectors on the MegaRAID SAS 9240-8i RAID controller.

**NOTE** The MegaRAID SAS 9240-4i RAID controller is like the MegaRAID SAS 9240-8i RAID controller except that the MegaRAID SAS 9240-4i RAID controller does not contain the J5 connector, which supports ports 4 to 7.

**Figure 9 Card Layout for the MegaRAID SAS 9240-8i RAID Controller**



The following table describes the jumpers and the connectors on the MegaRAID SAS 9240-4i and MegaRAID SAS 9240-8i RAID controllers.

**Table 3 MegaRAID SAS 9240-4i and MegaRAID SAS 9240-8i RAID Controllers – Jumpers and Connectors**

Jumper	Type	Description
J1	RISCwatch header	16-pin header Reserved for LSI use.
J2	CPLD header	10-pin header Reserved for LSI use.
J3	External LED drive activity/fault header	4-pin connector Connects to external, green or red LEDs that indicate drive activity or faults.
J4	x4 SAS Ports 0 to 3	SFF-8087 x4 internal mini SAS connector Connects the cables from the controller to SAS drives or SATA drives, or a SAS expander.
J5	x4 SAS Ports 4 to 7	SFF-8087 x4 internal mini SAS connector Connects the cables from the controller to SAS drives or SATA drives, or a SAS expander.  <b>NOTE</b> The MegaRAID SAS 9240-4i RAID controller does not have the J5 connector.
J6	PCIe x8 Board Edge connector	x8 interface that provides connections on both the top and the bottom of the board.
TP1	Universal Asynchronous Receiver/Transmitter (UART) debugging	4-pin connector Reserved for LSI use.

### 3.1.2 MegaRAID SAS 9260 RAID Controllers

The MegaRAID SAS 9260-4i low-profile SAS/SATA RAID controller controls four internal SAS/SATA ports through one SFF-8087 x4 internal mini SAS connector.

The MegaRAID SAS 9260-8i low-profile SAS/SATA RAID controller controls eight internal SAS/SATA ports through two SFF-8087 x4 internal mini SAS connectors.

The MegaRAID SAS 9260CV-4i low-profile SAS/SATA RAID controller controls four internal SAS/SATA ports through one SFF-8087 x4 internal mini SAS connector, and has a nonvolatile CVFM01 module attached. The CVFM01 module connects to a CVPM01 module to provide backup for your data in case of power loss.

The MegaRAID SAS 9260CV-8i low-profile SAS/SATA RAID controller controls eight internal SAS/SATA ports through two SFF-8087 x4 internal mini SAS connectors, and has a nonvolatile CVFM01 module attached. The CVFM01 module connects to a CVPM01 module to provide backup for your data in case of power loss.

The MegaRAID SAS 9260DE-8i low-profile SAS/SATA RAID controller controls eight internal SAS/SATA ports through two SFF-8087 x4 internal mini SAS connectors and offers data security by using disk encryption.

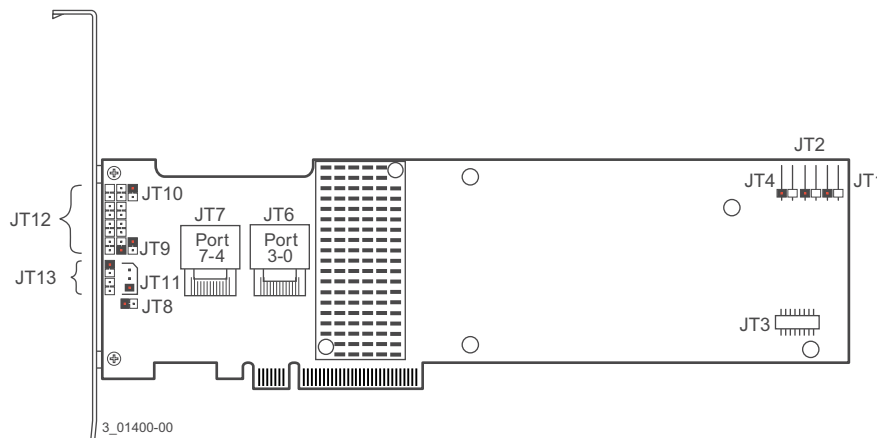
The MegaRAID SAS 9260-16i standard-height SAS/SATA RAID controller controls 16 internal SAS/SATA ports through four SFF-8087 x4 internal mini SAS connectors.

### 3.1.2.1 MegaRAID SAS 9260-4i, SAS 9260-8i, and SAS 9260DE-8i RAID Controllers – Board Layout and Jumper/Connector Information

This subsection provides the board layout, and the connector and jumper information for the MegaRAID SAS 9260-4i, SAS 9260-8i, and SAS 9260DE-8i RAID controllers. The following figure shows the connectors on the MegaRAID SAS 9260-8i RAID controller.

**NOTE** The MegaRAID SAS 9260-4i RAID controller has the same connectors as the MegaRAID SAS 9260-8i RAID controller except for the JT7 connector, which supports ports 4 to 7. The MegaRAID SAS 9260DE-8i RAID controller has the same connectors as the MegaRAID SAS 9260-8i RAID controller.

**Figure 10 Card Layout for the MegaRAID SAS 9260-8i RAID Controller**



**NOTE** JT1, JT2, and JT4 are behind the LSiIBBU07 unit when the iBBU unit is installed, but they are still accessible.

**NOTE** Pin 1 on the headers and connectors is highlighted in red in this figure.

The following table describes the jumpers and connectors on the MegaRAID SAS 9260-4i, SAS 9260-8i, and SAS 9260DE-8i RAID controllers.

**Table 4 MegaRAID SAS 9260-4i, SAS 9260-8i, and SAS 9260DE-8i RAID Controllers – Jumpers and Connectors**

Jumper	Type	Description
JT1	Write-Pending Indicator (dirty cache) LED connector	2-pin connector Connects to an LED that indicates when the data in the cache has yet to be written to the storage devices. Used when the write-back feature is enabled.
JT2	SAS Activity LED header	2-pin connector Connects to an LED that indicates drive activity.
JT3	Battery Backup Unit connector	20-pin connector Connects the optional LSiIBBU07 intelligent Battery Backup Unit or the optional LSiIBBU08 unit to the RAID controller remotely.
JT4	Global Drive Fault LED header	2-pin connector Connects to a single LED to indicate whether any drive is in a fault condition.
JT6	x4 SAS Ports 3 to 0	SFF-8087 x4 internal mini SAS connector Connects the cables from the RAID controller to SAS drives, SATA drives, or a SAS expander.

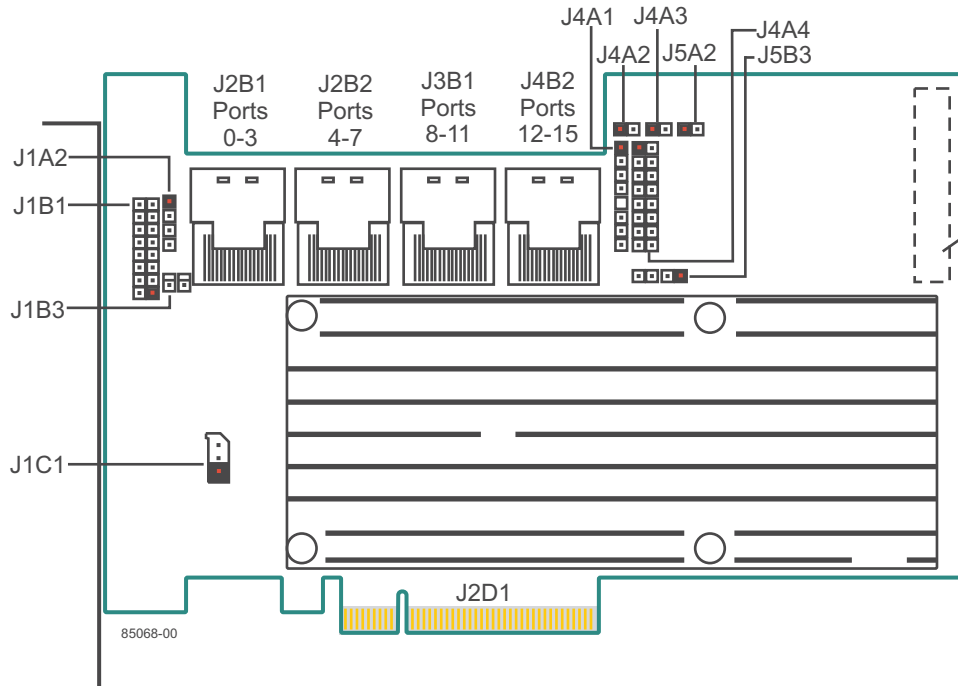
**Table 4 MegaRAID SAS 9260-4i, SAS 9260-8i, and SAS 9260DE-8i RAID Controllers – Jumpers and Connectors (Continued)**

Jumper	Type	Description
JT7	x4 SAS Ports 7 to 4	SFF-8087 x4 internal mini SAS connector Connects the cables from the RAID controller to SAS drives, SATA drives, or a SAS expander. <b>NOTE</b> The MegaRAID SAS 9260-4i RAID controller does not have this connector.
JT8	Advanced Software Options Hardware Key header	2-pin connector Enables support for the Advanced Software Options features, which include CacheCade, Recovery, and SafeStore™ disk encryption. <b>NOTE</b> FastPath is now a standard feature for this controller.
JT9	Set Factory Defaults connector	2-pin connector Reserved for LSI use.
JT10	LSI Test header	2-pin connector Reserved for LSI use.
JT11	IPMI-style SMBus (System Management)/I <sup>2</sup> C header	3-pin shielded header Provides enclosure management support.
JT12	Individual Drive Fault LED header for Eight Phys (0 to 7)	16-pin connector Indicates drive faults. There is one LED per port. When lit, each LED indicates the corresponding drive has failed or is in the Unconfigured-Bad state. Refer to the <i>MegaRAID SAS Software User Guide</i> for more information about drive states. The LEDs function in a direct-attach configuration (there are no SAS expanders). Direct attach is defined as a maximum of one drive connected directly to each port. <b>NOTE</b> This header is used for RAID controllers with internal SAS ports only.
JT13	Universal Asynchronous Receiver/Transmitter (UART) debugging	4-pin connector Reserved for LSI use.

### 3.1.2.2 MegaRAID SAS 9260-16i RAID Controller – Board Layout and Jumper/Connector Information

This subsection provides the board layout, and the connector and jumper information for the MegaRAID SAS 9260-16i RAID controller. The following figure shows the jumpers and connectors on the MegaRAID SAS 9260-16i RAID controller.

**Figure 11 Card Layout for the MegaRAID SAS 9260-16i RAID Controller**

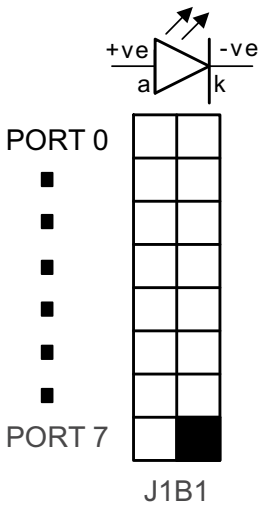


**NOTE** Pin 1 on the headers and connectors is highlighted in red in this figure.

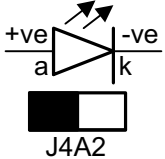
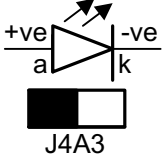
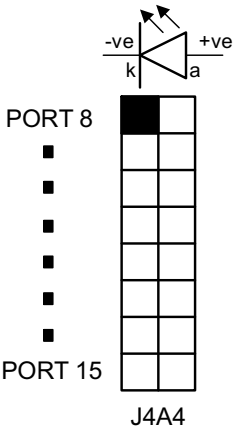


The following table describes the jumpers and the connectors on the MegaRAID SAS 9260-16i RAID controller. It includes diagrams that show Pin1 and its orientation for several of the connectors.

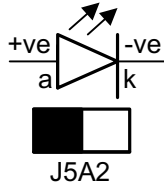
**Table 5 MegaRAID SAS 9260-16i RAID Controller – Connectors**

Jumper/ Connector	Type	Description
J1A2	Universal Asynchronous Receiver/Transmitter (UART) for the Expander	4-pin connector Reserved for LSI use.
J1B1	LED Locate and Fault Indication header Ports 0 to 3 Ports 4 to 7 	2x8-pin connector Connects to an LED array that indicates whether a drive is in a fault condition. There is one LED per port. When lit, each LED indicates the corresponding drive has failed or is in the unconfigured-bad state. The LEDs function in a direct-attach configuration (there are no SAS expanders). Direct attach is defined as a maximum of one drive connected directly to each port. <b>NOTE</b> This header is used for RAID controllers with internal SAS ports only.
J1B3	Advanced Software Options Hardware Key header	2-pin header Enables support for the Advanced Software Options features, which include CacheCade, Recovery, and SafeStore disk encryption. <b>NOTE</b> FastPath is now a standard feature for this controller.
J1C1	IPMI-style I <sup>2</sup> C connector	3-pin connector Supports SES (SCSI enclosure services) over I <sup>2</sup> C through an internal I <sup>2</sup> C backplane cable.
J1L1	Remote Battery Backup connector (on the rear of the controller)	20-pin connector Connects the optional LSIiBBU07 intelligent Battery Backup Unit or the optional LSIiBBU08 unit to the RAID controller remotely.
J2B1	x4 SAS Ports 0 to 3 Internal connector	SFF-8087 x4 internal mini SAS connector Connects the controller by cable to SAS drives or SATA 2 drives.
J2B2	x4 SAS Ports 4 to 7 Internal connector	SFF-8087 x4 internal mini SAS connector Connects the controller by cable to SAS drives or SATA 2 drives.
J2D1	Standard Edge Card connector	The RAID controller interfaces with the host system through a standard edge card. This interface provides power to the board and an I <sup>2</sup> C interface connected to the I <sup>2</sup> C bus for IPMI.

**Table 5 MegaRAID SAS 9260-16i RAID Controller – Connectors (Continued)**

Jumper/ Connector	Type	Description
J3B1	x4 SAS Ports 8-11 internal connector	SFF-8087 x4 internal mini SAS connector Connects the controller by cable to SAS drives or SATA 2 drives.
J4A1	Module CPLD	1x8-pin connector Reserved for LSI use.
J4A2	Activity LED header 	2-pin connector Connects to an LED that indicates activity on the drives connected to the controller.
J4A3	Global Drive Fault LED header 	2-pin connector Connects to an LED that indicates whether a drive is in a fault condition.
J4A4	LED Locate and Fault Indication header Ports 8 to 11 Ports 12 to 15 	2x8-pin header Connects to an LED array that indicates whether a drive is in a fault condition. There is one LED per port. When lit, each LED indicates the corresponding drive has failed or is in the Unconfigured-Bad state. The LEDs function in a direct-attach configuration (there are no SAS expanders). Direct attach is defined as a maximum of one drive connected directly to each port. <b>NOTE</b> This header is used for RAID controllers with internal SAS ports only.

**Table 5 MegaRAID SAS 9260-16i RAID Controller – Connectors (Continued)**

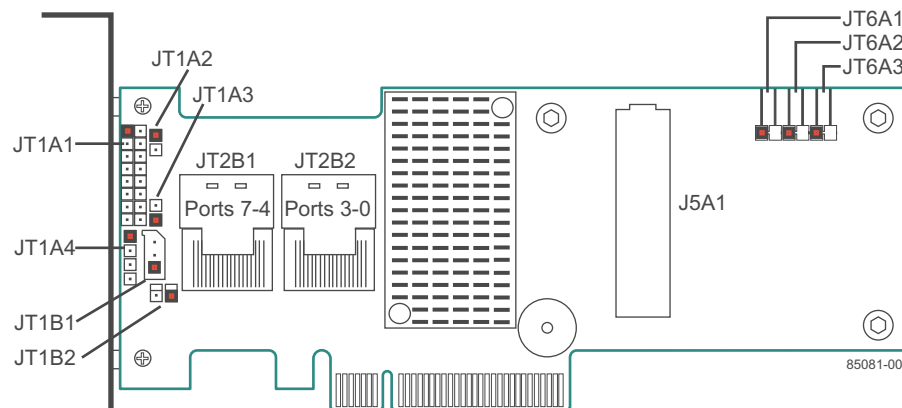
Jumper/Connector	Type	Description
J4B2	x4 SAS Ports 12 to 15 Internal connector	SFF-8087 x4 internal mini SAS connector Connects the controller by cable to SAS drives or SATA 2 drives.
J5A2	Write-Pending LED header 	2-pin connector Connects to an LED that indicates when the data in the cache has yet to be written to the storage devices. Used when the write-back feature is enabled.
J5B3	Universal Asynchronous Receiver/Transmitter (UART) debugging	4-pin connector Reserved for LSI use.

**3.1.2.3 MegaRAID SAS 9260CV-4i and MegaRAID SAS 9260CV-8i RAID Controllers – Board Layout and Jumper/Connector Information**

This subsection provides the board layout, and connector and jumper information for the RAID controller. The following figure shows the location of the jumpers and the connectors on the MegaRAID SAS 9260CV-8i RAID controller. The jumpers are set at the factory, and you usually do not need to change them.

**NOTE** The MegaRAID SAS 9260CV-4i RAID controller does not contain the JT2B1 connector, which supports ports 4 to 7. The JT2B1 connector is on the MegaRAID SAS 9260CV-8i RAID controller.

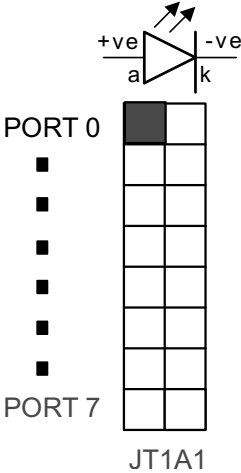
**Figure 12 Card Layout for the MegaRAID SAS 9260CV-8i RAID Controller**



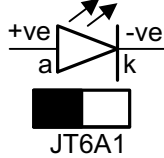
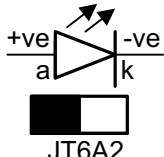
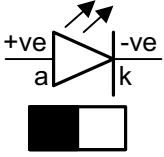
**NOTE** Pin 1 on the headers and connectors is highlighted in red in this figure.

The following table describes the jumpers and the connectors on the MegaRAID SAS 9260CV-8i RAID controller.

**Table 6 MegaRAID SAS 9260CV-4i and MegaRAID SAS 9260CV-8i RAID Controllers – Jumpers and Connectors**

Jumper/Connector	Type	Description
J5A1	Board-to-Board Mezzanine connector	240-pin 01 nonvolatile memory module interface Connects the controller directly to a CVFM01 module. The CVFM01 module connects to a remote CVPM01 module. Refer to the <i>MegaRAID SAS 9260CV-4i and SAS 9260CV-8i RAID Controllers Quick Installation Guide</i> for the procedure used to connect a CVFM01 module to a remote CVPM01 module.
JT1A1	LED Locate and Fault Indication header Ports 0 to 3 Ports 4 to 7 	2x8-pin header Connects to an LED array that indicates whether a drive is in a fault condition. There is one LED per port. When lit, each LED indicates the corresponding drive has failed or is in the Unconfigured-Bad state. The LEDs function in a direct-attach configuration (there are no SAS expanders). Direct attach is defined as a maximum of one drive connected directly to each port. <b>NOTE</b> The MegaRAID SAS 9260CV-4i RAID controller does not contain the JT2B1 connector, which supports ports 4 to 7.
JT1A2	LSI Internal Use header	Reserved for LSI internal use.
JT1A3	SBR Firmware Recovery header	2-pin header The SBR FW recovery header is used when SBR corruption is suspected. Installing the jumper lets the unit boot while bypassing the SBR information. You can then reprogram the SEEPROM using external utility software. No jumper is present for normal operation.
JT1A4	Serial UART header	Reserved for LSI internal use.
JT1B1	SEP Enclosure Support header	3-pin header Used for connection to the Port0 enclosure.
JT1B2	Advanced Software Options Hardware Key header	2-pin header Enables support for the Advanced Software Options features, which include CacheCade, Recovery, and SafeStore disk encryption. <b>NOTE</b> FastPath is now a standard feature for this controller.
JT2B1	x4 SAS Ports 4 to 7 Mini-SAS 4i Internal connector	SFF-8087 x4 internal mini SAS connector Connects the controller by cable to SAS drives or SATA 2 drives. <b>NOTE</b> The MegaRAID SAS 9260CV-4i RAID controller does not contain the JT2B1 connector.

**Table 6 MegaRAID SAS 9260CV-4i and MegaRAID SAS 9260CV-8i RAID Controllers – Jumpers and Connectors (Continued)**

Jumper/ Connector	Type	Description
JT2B2	x4 SAS Ports 0 to 3 Mini-SAS 4i Internal connector	SFF-8087 x4 internal mini SAS connector Connects the controller by cable to SAS drives or SATA 2 drives.
JT2B3	Standard Edge Card connector	The RAID controller interfaces with the host system through a standard edge card.  This interface provides power to the board and an I <sup>2</sup> C interface connected to the I <sup>2</sup> C bus for IPMI.
JT6A1	Global Drive Fault LED header 	2-pin connector Connects to an LED that indicates whether a drive is in a fault condition.
JT6A2	Hard Disk Drive Activity LED header 	2-pin connector Connects to an LED that indicates activity on the drives connected to the controller.
JT6A3	Write-Pending LED header 	2-pin connector Connects to an LED that indicates when the data in the cache has yet to be written to the storage devices. Used when the write-back feature is enabled.

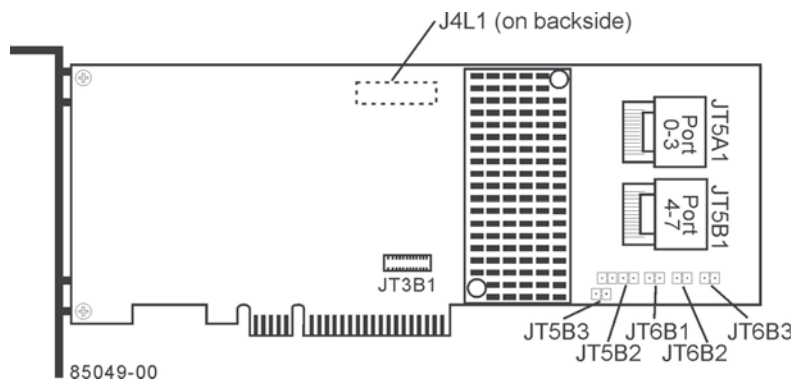
### 3.1.3 MegaRAID SAS 9261 RAID Controller

The MegaRAID SAS 9261-8i low-profile SAS/SATA RAID controller controls eight internal SAS/SATA ports through two SFF-8087 mini-SAS 4i connectors.

#### 3.1.3.1 MegaRAID SAS 9261-8i RAID Controller – Board Layout and Jumper/Connector Information

This subsection provides the board layout, and the connector and jumper information for the MegaRAID SAS 9261-8i RAID controller. The following figure shows the jumpers and connectors on the MegaRAID SAS 9261-8i RAID controller.

**Figure 13 Card Layout for the MegaRAID SAS 9261-8i RAID Controller**



The following table describes the jumpers and the connectors on the MegaRAID SAS 9261-8i RAID controller.

**Table 7 MegaRAID SAS 9261-8i RAID Controller – Jumpers and Connectors**

Jumper	Type	Description
J4L1	Remote Battery Backup Unit connector (on the rear of the controller)	20-pin connector Connects an optional remote LSiBBU07 intelligent Battery Backup Unit or an LSiBBU08 unit to the RAID controller.
JT3B1	Battery Backup Unit connector	20-pin connector Connects an optional LSiBBU07 intelligent Battery Backup Unit or an optional LSiBBU08 unit directly to the RAID controller.
JT5A1	x4 SAS Ports 0 to 3 Mini-SAS 4i connector	Connects the cables from the RAID controller to SAS drives or SATA drives, or a SAS expander.
JT5B1	x4 SAS Ports 4 to 7 Mini-SAS 4i connector	Connects the cables from the RAID controller to SAS drives or SATA drives, or a SAS expander.
JT5B2	Universal Asynchronous Receiver/Transmitter (UART) debugging	4-pin connector Reserved for LSI use.
JT5B3	Set Factory Defaults connector	2-pin connector Reserved for LSI use.
JT6B1	Test header	2-pin connector Reserved for LSI use.
JT6B2	Global Drive Fault LED header	2-pin connector Connects to an LED that indicates whether a drive is in a fault condition.
JT6B3	SAS Activity LED header	2-pin connector Connects to an LED that indicates drive activity.

### 3.1.4 MegaRAID SAS 9265 RAID Controllers

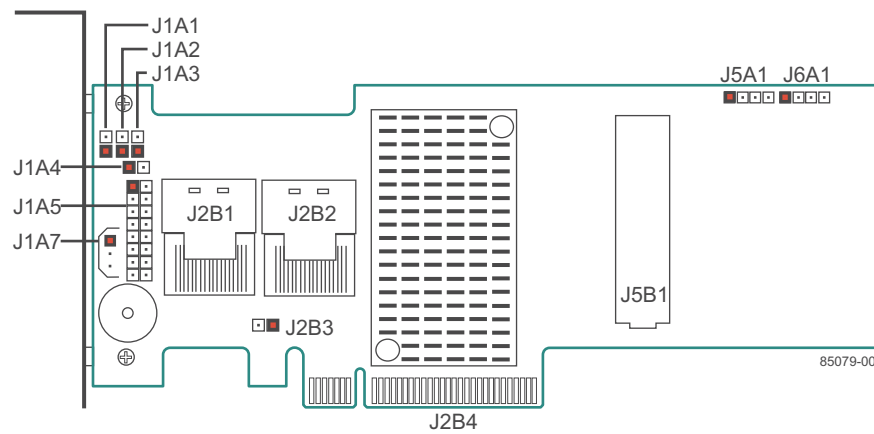
The 6Gb/s MegaRAID SAS 9265-8i low-profile SAS/SATA RAID controller controls eight internal SAS/SATA ports through two SFF-8087 x4 internal mini SAS connectors.

The 6Gb/s MegaRAID SAS 9265CV-8i low-profile SAS/SATA RAID controller controls eight internal SAS/SATA ports through two SFF-8087 x4 internal mini SAS connectors. This controller supports a CacheVault Flash Module, CVFM03, that connects to a CVPM02 module to provide backup for your data in case of power loss.

#### 3.1.4.1 MegaRAID SAS 9265-8i RAID Controller – Board Layout and Jumper/Connector Information

This subsection provides the board layout, and the connector and jumper information for the MegaRAID SAS 9265-8i RAID controller. The following figure shows the location of the jumpers and the connectors on the MegaRAID SAS 9265-8i RAID controller. The jumpers are set at the factory, and you usually do not need to change them.

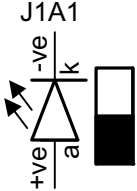
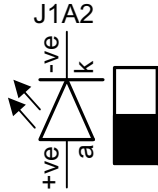
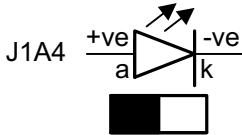
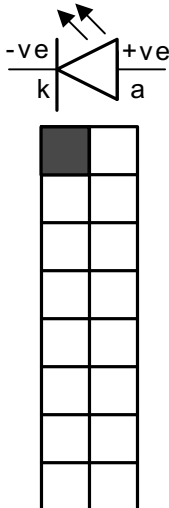
**Figure 14 Card Layout for the MegaRAID SAS 9265-8i RAID Controller**



**NOTE** Pin 1 on the headers and connectors is highlighted in red in this figure.

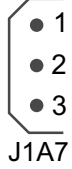
The following table describes the jumpers and the connectors on the MegaRAID SAS 9265-8i RAID controller.

**Table 8 MegaRAID SAS 9265-8i RAID Controller – Jumpers and Connectors**

Jumper/ Connector	Type	Description
J1A1	Global Drive Fault LED header 	2-pin connector Connects to an LED that indicates whether a drive is in a fault condition.
J1A2	Write-Pending LED header 	2-pin connector Connects to an LED that indicates when the data in the cache has yet to be written to the storage devices. Used when the write-back feature is enabled.
J1A3	LSI Test header	2-pin connector Reserved for internal use.
J1A4	Activity LED header 	2-pin connector Connects to an LED that indicates activity on the drives connected to the controller.
J1A5	Individual PHY and Drive Fault Indication header Ports 0 to 3 Ports 4 to 7  J1A5	2x8-pin header Connects to an LED that indicates whether a drive is in a fault condition. There is one LED per port. When lit, each LED indicates the corresponding drive has failed or is in the Unconfigured-Bad state. The LEDs function in a direct-attach configuration (there are no SAS expanders). Direct attach is defined as a maximum of one drive connected directly to each port.



**Table 8 MegaRAID SAS 9265-8i RAID Controller – Jumpers and Connectors (Continued)**

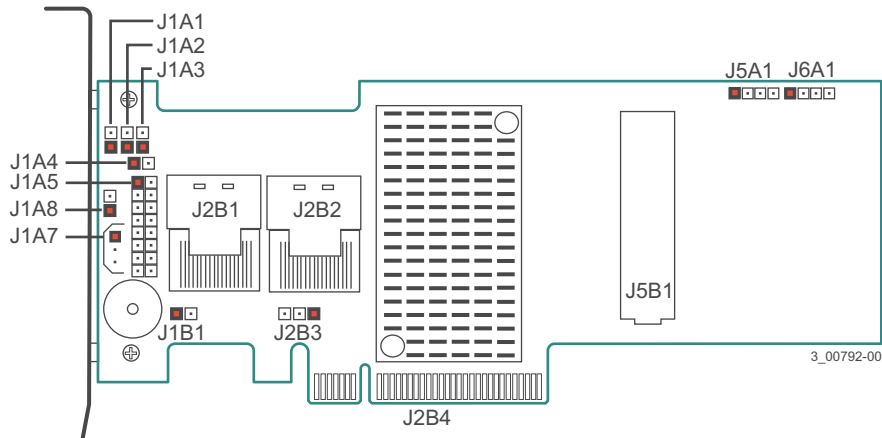
Jumper/ Connector	Type	Description
J1A7	I <sup>2</sup> C Enclosure Management connector 	3-pin connector Supports SES (SCSI enclosure services) over I <sup>2</sup> C through an internal I <sup>2</sup> C backplane cable.
J1B1	Serial EEPROM (SBR)	2-pin connector Provides controller information, such as the serial number, revision, and manufacturing date. The default is no shunt installed.
J2B1	x4 SAS Ports 0 to 3 Internal connector	SFF-8087 mini SAS 4i internal connector Connects the controller by cable to SAS drives or SATA 2 drives.
J2B2	x4 SAS Ports 4 to 7 Internal connector	SFF-8087 mini SAS 4i internal connector Connects the controller by cable to SAS drives or SATA 2 drives.
J2B3	Advanced Software Options Hardware Key header	3-pin header Enables support for the Advanced Software Options features, which include CacheCade, Recovery, and SafeStore disk encryption. <b>NOTE</b> FastPath is now a standard feature for this controller.
J2B4	Standard Edge Card connector	The RAID controller interfaces with the host system through a standard edge card. This interface provides power to the board and an I <sup>2</sup> C interface connected to the I <sup>2</sup> C bus for IPMI.
J5A1	Serial Universal Asynchronous Receiver/Transmitter (UART) connector for the Expander	4-pin connector Reserved for LSI use.
J5B1	Board-to-board Mezzanine connector	240-pin DDR3 nonvolatile memory module interface Connects the controller directly to a CVFM module. The CVFM module can connect to an optional remote LSiBBU09 intelligent battery backup unit. Refer to the <i>MegaRAID LSiBBU09 Intelligent Battery Backup Unit Quick Installation Guide</i> for the procedure used to connect a CVFM module to a remote LSiBBU09 unit.
J6A1	Serial Universal Asynchronous Receiver/Transmitter (UART) connector for the expander	4-pin connector Reserved for LSI use.

### 3.1.4.2 MegaRAID SAS 9265CV-8i RAID Controller – Board Layout and Jumper/Connector Information

This subsection provides the board layout, and the connector and jumper information for the MegaRAID SAS 9265CV-8i RAID controller.

The following figure shows the location of the jumpers and the connectors on the MegaRAID SAS 9265CV-8i RAID controller. The jumpers are set at the factory, and you usually do not need to change them.

**Figure 15 Card Layout for the MegaRAID SAS 9265CV-8i RAID Controller**



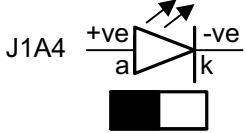
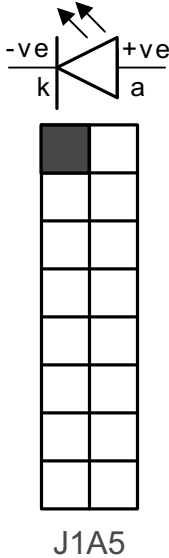
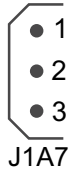
**NOTE** Pin 1 on the headers and connectors is highlighted in red in this figure.

The following table describes the jumpers and the connectors on the MegaRAID SAS 9265CV-8i RAID controller.

**Table 9 MegaRAID SAS 9265CV-8i RAID Controller – Jumpers and Connectors**

Jumper/Connector	Type	Description
J1A1	Global Drive Fault LED header	2-pin connector Connects to an LED that indicates whether a drive is in a fault condition.
J1A2	Write-Pending LED header	2-pin connector Connects to an LED that indicates when the data in the cache has yet to be written to the storage devices. Used when the write-back feature is enabled.
J1A3	LSI Test header	2-pin connector Reserved for internal use.

**Table 9 MegaRAID SAS 9265CV-8i RAID Controller – Jumpers and Connectors (Continued)**

Jumper/ Connector	Type	Description
J1A4	Activity LED header 	2-pin connector Connects to an LED that indicates activity on the drives connected to the controller.
J1A5	Individual PHY and Drive Fault Indication header Ports 0 to 3 Ports 4 to 7 	2x8-pin header Connects to an LED that indicates whether a drive is in a fault condition. There is one LED per port. When lit, each LED indicates the corresponding drive has failed or is in the Unconfigured-Bad state. The LEDs function in a direct-attach configuration (there are no SAS expanders). Direct attach is defined as a maximum of one drive connected directly to each port.
J1A7	I <sup>2</sup> C Enclosure Management connector 	3-pin connector Supports SES (SCSI enclosure services) over I <sup>2</sup> C through an internal I <sup>2</sup> C backplane cable.
J1B1	Serial EEPROM (SBR)	2-pin connector Provides controller information, such as the serial number, revision, and manufacturing date. The default is no shunt installed.
J2B1	x4 SAS Ports 0 to 3 Internal connector	SFF-8087 mini SAS 4i internal connector Connects the controller by cable to SAS drives or SATA drives.
J2B2	x4 SAS Ports 4 to 7 Internal connector	SFF-8087 mini SAS 4i internal connector Connects the controller by cable to SAS drives or SATA drives.

**Table 9 MegaRAID SAS 9265CV-8i RAID Controller – Jumpers and Connectors (Continued)**

Jumper/ Connector	Type	Description
J2B3	Advanced Software Options Hardware Key header	3-pin header Enables support for the Advanced Software Options features, which include CacheCade, Recovery, and SafeStore disk encryption. <b>NOTE</b> FastPath is now a standard feature for this controller.
J2B4	Standard Edge Card connector	The RAID controller interfaces with the host system through a standard edge card. This interface provides power to the board and an I <sup>2</sup> C interface connected to the I <sup>2</sup> C bus for IPMI.
J5A1	Serial Universal Asynchronous Receiver/Transmitter (UART) connector for the expander	4-pin connector Reserved for LSI use.
J5B1	Board-to-Board Mezzanine connector	240-pin 02 DDR3 nonvolatile memory module interface Connects a CacheVault Flash Module, CVFM03, directly to the RAID controller. The CVFM03 module connects to a CacheVault Power Module 02, CVPM02, that is mounted on a remote mount board. Refer to the <i>MegaRAID SAS 9265CV-8e RAID Controller Quick Installation Guide</i> for the procedure used to connect the CVFM03 module to the CVPM02 module.
J6A1	Serial Universal Asynchronous Receiver/Transmitter (UART) connector for the expander	4-pin connector Reserved for LSI use.

### 3.1.5 MegaRAID SAS 9266 RAID Controllers

The MegaRAID SAS 9266-4i low-profile SAS/SATA RAID controller controls four internal SAS/SATA ports through one SFF-8087 mini SAS 4i internal connector.

The MegaRAID SAS 9266-8i low-profile SAS/SATA RAID controller controls eight internal SAS/SATA ports through two SFF-8087 mini SAS 4i internal connectors. This controller supports a nonvolatile CVFM02 module that connects to a CVPM02 module to provide backup for your data in case of power loss.

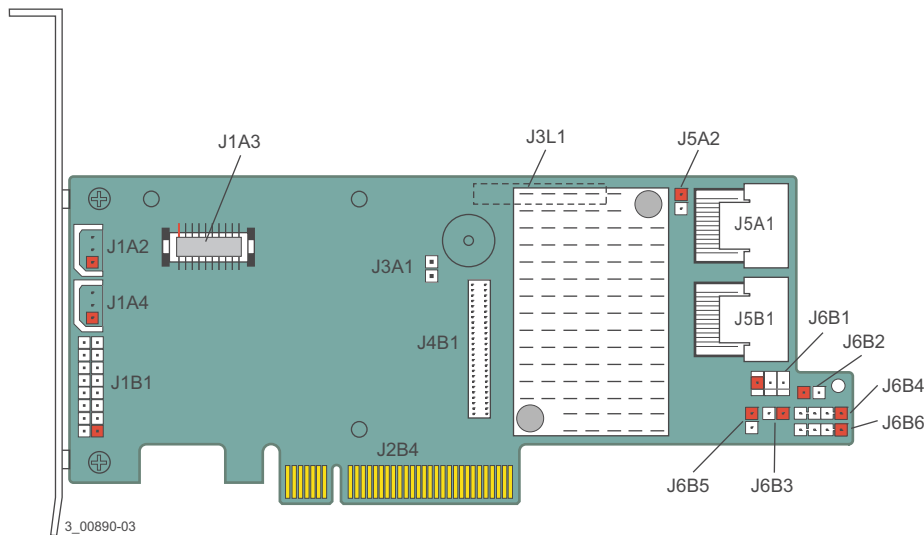
**NOTE** The MegaRAID SAS 9266-4i RAID controller does not contain the J5B1 connector, which supports ports 4 to 7. The J5B1 connector is on the MegaRAID SAS 9266-8i RAID controller.

### 3.1.5.1 MegaRAID SAS 9266 RAID Controller – Board Layout and Jumper/Connector Information

This subsection provides the board layout, and the connector and jumper information for the MegaRAID SAS 9266-8i RAID controller. The MegaRAID SAS 9266-4i RAID controller is the same as the MegaRAID SAS 9266-8i RAID controller, except that it does not support the J5B1 port connector.

The following figure shows the jumpers and the connectors on the RAID controller. The jumpers are set at the factory, and you usually do not need to change them.

**Figure 16 Card Layout for the MegaRAID SAS 9266-8i RAID Controller**



The following table describes the jumpers and the connectors on the MegaRAID SAS 9266 RAID controller.

**Table 10 MegaRAID SAS 9266 RAID Controllers – Jumpers and Connectors**

Jumper/ Connector	Type	Description
J1A2	SCS Backplane Management connector	3-pin shielded header Implements an enclosure management module that is responsible for providing enclosure management functions for storage enclosures and server backplanes.
J1A3	Local Battery Backup Unit connector	20-pin connector Connects the LSIIBBU09 unit directly to the RAID controller.
J1A4	SCS Backplane Management connector	3-pin shielded header Implements an enclosure management module that is responsible for providing enclosure management functions for storage enclosures and server backplanes.
J1B1	Individual PHY and Drive Fault Indication header Ports 3 to 0 Ports 7 to 4	2x8-pin header Connects to an LED that indicates whether a drive is in a fault condition. There is one LED per port. When lit, each LED indicates the corresponding drive has failed or is in the Unconfigured-Bad state. The LEDs function in a direct-attach configuration (there are no SAS expanders). Direct attach is defined as a maximum of one drive connected directly to each port.

**Table 10 MegaRAID SAS 9266 RAID Controllers – Jumpers and Connectors (Continued)**

Jumper/ Connector	Type	Description
J2B4	Standard Edge Card connector	The interface between the RAID controller and the host system. This interface provides power to the board and an I <sup>2</sup> C interface connected to the I <sup>2</sup> C bus for the Intelligent Platform Management Interface (IPMI).
J3A1	Drive Activity LED header	2-pin connector This connector is not used.
J3L1	Remote Battery Backup connector	20-pin connector Connects a remote LSiBBU09 unit to RAID controller.
J4B1	CacheVault Flash Module DDR3 interface	70-pin connector Connects the RAID controller to a CVFM02 module. The CVFM02 module connects to a remote CVPM02 module.
J5A1	x4 SAS Port 0 through Port 3 Internal connector	SFF-8087 mini SAS 4i internal connector Connects the controller by cable to SAS drives or SATA drives.
J5A2	Write-Pending LED header	2-pin connector Connects to an LED that indicates when the data in the cache has yet to be written to the storage devices. Used when the write-back feature is enabled.
J5B1	x4 SAS Ports 4 to 7 Internal connector	SFF-8087 mini SAS 4i internal connector Connects the controller by cable to SAS drives or SATA drives. <b>NOTE</b> The MegaRAID SAS 9266-4i RAID controller does not contain the J5B1 connector.
J6B1	Advanced Software Options Hardware Key header	3-pin header Enables support for the Advanced Software Options features, which include CacheCade, Recovery, and SafeStore disk encryption. <b>NOTE</b> FastPath is now a standard feature for this controller.
J6B2	SBR Bypass header	2-pin connector Lets you bypass the SBR EEPROM during boot in case the EEPROM contents are corrupt or missing.
J6B3	Global Activity LED header	2-pin header Connects to a single LED that indicates drive activity on either port.
J6B4	Onboard Serial Universal Asynchronous Receiver/Transmitter (UART) connector	4-pin connector Reserved for LSI use.
J6B5	Global Drive Fault LED indicator	2-pin header Connects to a single LED that indicates drive activity on either port.
J6B6	Onboard Serial Universal Asynchronous Receiver/Transmitter (UART) connector	4-pin connector Reserved for LSI use.

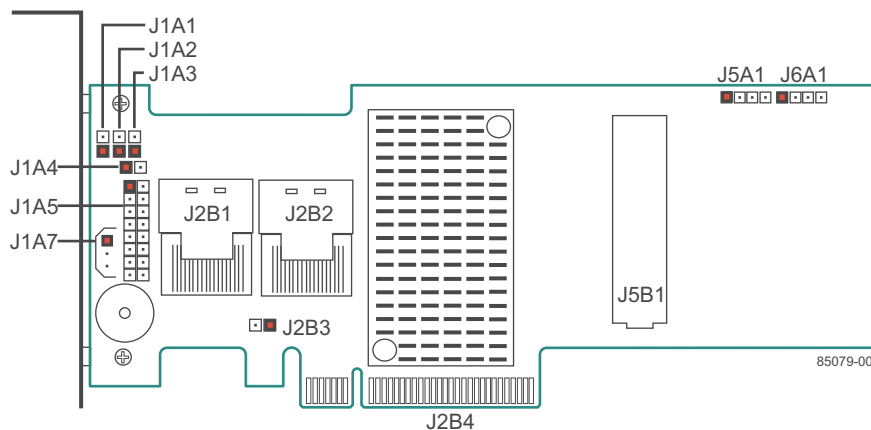
### 3.1.6 MegaRAID SAS 9270 RAID Controller

The MegaRAID SAS 9270-8i low-profile SAS/SATA disk array controller controls eight internal SAS/SATA ports through two SFF-8087 mini-SAS 4i internal connectors.

#### 3.1.6.1 MegaRAID SAS 9270-8i RAID Controller – Board Layout and Jumper/Connector Information

This subsection provides the board layout, and the connector and jumper information for the MegaRAID SAS 9270-8i RAID controller. The following figure shows the location of the jumpers and the connectors on the MegaRAID SAS 9270-8i RAID controller. The jumpers are set at the factory, and you usually do not need to change them.

**Figure 17 Card Layout for the MegaRAID SAS 9270-8i RAID Controller**



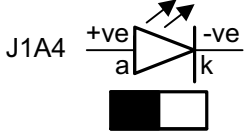
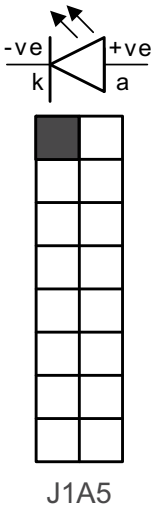
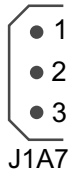
**NOTE** Pin 1 on the headers and connectors is highlighted in red in this figure.

The following table describes the jumpers and the connectors on the MegaRAID SAS 9270-8i RAID controller.

**Table 11 MegaRAID SAS 9270-8i RAID Controller – Jumpers and Connectors**

Jumper/ Connector	Type	Description
J1A1	Global Drive Fault LED header	2-pin connector Connects to an LED that indicates whether a drive is in a fault condition.
J1A2	Write-Pending LED header	2-pin connector Connects to an LED that indicates when the data in the cache has yet to be written to the storage devices. Used when the write-back feature is enabled.
J1A3	LSI Test header	2-pin connector Reserved for internal use.

**Table 11 MegaRAID SAS 9270-8i RAID Controller – Jumpers and Connectors (Continued)**

Jumper/ Connector	Type	Description
J1A4	Activity LED header 	2-pin connector Connects to an LED that indicates activity on the drives connected to the controller.
J1A5	Individual PHY and Drive Fault Indication header Ports 0 to 3 Ports 4 to 7 	2x8-pin header Connects to an LED that indicates whether a drive is in a fault condition. There is one LED per port. When lit, each LED indicates the corresponding drive has failed or is in the Unconfigured-Bad state. The LEDs function in a direct-attach configuration (there are no SAS expanders). Direct attach is defined as a maximum of one drive connected directly to each port.
J1A7	I <sup>2</sup> C Enclosure Management connector 	3-pin connector Supports SES (SCSI enclosure services) over I <sup>2</sup> C through an internal I <sup>2</sup> C backplane cable.
J1B1	Serial EEPROM (SBR)	2-pin connector Provides controller information, such as the serial number, revision, and manufacturing date. The default is no shunt installed.
J2B1	x4 SAS Ports 0 to 3 Internal connector	SFF-8087 mini SAS 4i internal connector Connects the controller by cable to SAS drives or SATA 2 drives.
J2B2	x4 SAS Ports 4 to 7 Internal connector	SFF-8087 mini SAS 4i internal connector Connects the controller by cable to SAS drives or SATA 2 drives.



**Table 11 MegaRAID SAS 9270-8i RAID Controller – Jumpers and Connectors (Continued)**

Jumper/ Connector	Type	Description
J2B3	Advanced Software Options Hardware Key header	3-pin header Enables support for the Advanced Software Options features, which include CacheCade, Recovery, and SafeStore disk encryption. <b>NOTE</b> FastPath is now a standard feature for this controller.
J2B4	Standard Edge Card connector	The RAID controller interfaces with the host system through a standard edge card. This interface provides power to the board and an I <sup>2</sup> C interface connected to the I <sup>2</sup> C bus for IPMI.
J5A1	Serial Universal Asynchronous Receiver/Transmitter (UART) connector for the Expander	4-pin connector Reserved for LSI use.
J5B1	Board-to-board Mezzanine connector	240-pin DDR3 nonvolatile memory module interface Connects the controller directly to a CVFM module. The module can connect to an optional remote LSiBBU09 intelligent battery backup unit. Refer to the <i>MegaRAID LSiBBU09 Intelligent Battery Backup Unit Quick Installation Guide</i> for the procedure used to connect a CVFM module to a remote LSiBBU09 unit.
J6A1	Serial Universal Asynchronous Receiver/Transmitter (UART) connector for the expander	4-pin connector Reserved for LSI use.

### 3.1.7 MegaRAID SAS 9271 RAID Controllers

The MegaRAID SAS 9271-4i low-profile SAS/SATA RAID controller controls four internal SAS/SATA ports through one SFF-8087 mini SAS 4i internal connector.

The MegaRAID SAS 9271-8i low-profile SAS/SATA RAID controller controls eight internal SAS/SATA ports through two SFF-8087 mini SAS 4i internal connectors. This controller supports a nonvolatile CVFM02 module that connects to a CVP02 module to provide backup for your data in case of power loss.

The MegaRAID SAS 9271-8iCC RAID controller controls eight internal SAS+SATA ports through two SFF-8087 mini SAS 4i internal connectors. This RAID controller ships as standard with CacheCade (CC) Pro 2.0 and Fast Path software enabled out of the box.

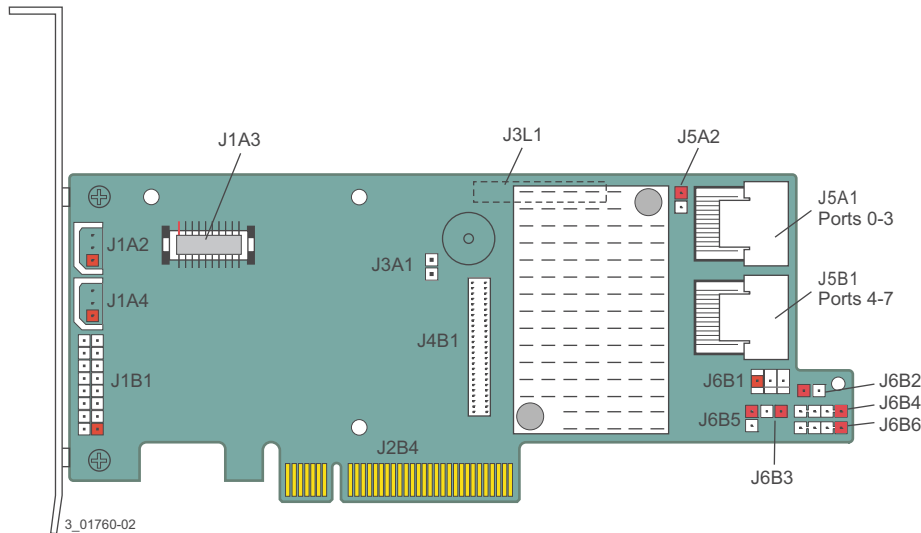
**NOTE** The MegaRAID SAS 9271-4i RAID controller does not contain the J5B1 connector, which supports ports 4 to 7. The J5B1 connector is on the MegaRAID SAS 9271-8i RAID controller and on the MegaRAID SAS 9271-8iCC RAID controller.

### 3.1.7.1 MegaRAID SAS 9271 RAID Controller – Board Layout and Jumper/Connector Information

This subsection provides the board layout, and the connector and jumper information for the MegaRAID SAS 9271-8i RAID controller.

The following figure shows the jumpers and the connectors on the RAID controller. The jumpers are set at the factory, and you usually do not need to change them.

**Figure 18 Card Layout for the MegaRAID SAS 9271-8i RAID Controller**



**NOTE** Pin 1 on the headers and connectors is highlighted in red in this figure.

The following table describes the jumpers and the connectors on the MegaRAID SAS 9271 RAID controllers.

**Table 12 MegaRAID SAS 9271 RAID Controllers – Jumpers and Connectors**

Jumper/Connector	Type	Description
J1A2	SCS Backplane Management connector	3-pin shielded header Implements an enclosure management module that is responsible for providing enclosure management functions for storage enclosures and server backplanes.
J1A3	Local Battery Backup Unit connector	20-pin connector Connects the LSIIBBU09 unit directly to the RAID controller.
J1A4	SCS Backplane Management connector	3-pin shielded header Implements an enclosure management module that is responsible for providing enclosure management functions for storage enclosures and server backplanes.
J1B1	Individual PHY and Drive Fault Indication header Ports 3 to 0 Ports 7 to 4	2x8-pin header Connects to an LED that indicates whether a drive is in a fault condition. There is one LED per port. When lit, each LED indicates the corresponding drive has failed or is in the Unconfigured-Bad state.  The LEDs function in a direct-attach configuration (there are no SAS expanders). Direct attach is defined as a maximum of one drive connected directly to each port.

**Table 12 MegaRAID SAS 9271 RAID Controllers – Jumpers and Connectors (Continued)**

Jumper/ Connector	Type	Description
J2B4	Standard Edge Card connector	The interface between the RAID controller and the host system. This interface provides power to the board and an I <sup>2</sup> C interface connected to the I <sup>2</sup> C bus for the Intelligent Platform Management Interface (IPMI).
J3A1	Drive Activity LED header	2-pin connector Connects to an LED that indicates activity on the drives connected to the controller.
J3L1	Remote Battery Backup connector	20-pin connector Connects a remote LSiBBU09 unit to RAID controller.
J4B1	CacheVault Flash Module DDR3 interface	70-pin connector Connects the RAID controller to a CVFM02 module. The CVFM02 module connects to a remote CVPM02 module.
J5A1	x4 SAS Port 0 through Port 3 Internal connector	SFF-8087 mini SAS 4i internal connector Connects the controller by cable to SAS drives or SATA drives.
J5A2	Write-Pending LED header	2-pin connector Connects to an LED that indicates when the data in the cache has yet to be written to the storage devices. Used when the write-back feature is enabled.
J5B1	x4 SAS Ports 4 to 7 Internal connector	SFF-8087 mini SAS 4i internal connector Connects the controller by cable to SAS drives or SATA drives. <b>NOTE</b> The MegaRAID SAS 9271-4i RAID controller does not contain the J5B1 connector. This connector is on the MegaRAID SAS 9271-8i RAID controller.
J6B1	Advanced Software Options Hardware Key header	3-pin header Enables support for the Advanced Software Options features, which include CacheCade, Recovery, and SafeStore disk encryption. <b>NOTE</b> FastPath is now a standard feature for this controller.
J6B2	SBR Bypass header	2-pin connector Lets you bypass the SBR EEPROM during boot in case the EEPROM contents are corrupt or missing.
J6B3	Global Activity LED header	2-pin header Connects to a single LED that indicates drive activity on either port.
J6B4	Onboard Serial Universal Asynchronous Receiver/Transmitter (UART) connector	4-pin connector Reserved for LSI use.
J6B5	Global Drive Fault LED indicator	2-pin header Connects to a single LED that indicates drive activity on either port.
J6B6	Onboard Serial Universal Asynchronous Receiver/Transmitter (UART) connector	4-pin connector Reserved for LSI use.

### 3.1.8 MegaRAID SAS 9280 RAID Controllers

The MegaRAID SAS 9280-4i4e low-profile SAS/SATA RAID controller controls four internal SAS/SATA ports through one SFF-8087 x4 internal mini SAS connector and four external SAS/SATA ports through one SFF-8087 x4 external mini SAS connector.

The MegaRAID SAS 9280-8e low-profile SAS/SATA RAID controller controls eight external SAS/SATA ports through two SFF-8088 x4 external mini SAS connectors.

The MegaRAID SAS 9280DE-8e low-profile SAS/SATA RAID controller controls eight external SAS/SATA ports through two SFF-8088 x4 external mini SAS connectors and offers data security using disk encryption.

The MegaRAID SAS 9280-16i4e standard-height SAS/SATA RAID controller controls 16 internal SAS/SATA ports through four SFF-8087 x4 internal mini SAS connectors and four external SAS/SATA ports through one SFF-8087 x4 external mini SAS connector.

The MegaRAID SAS 9280-24i4e standard-height SAS/SATA RAID controller controls 24 internal SAS/SATA ports through six SFF-8087 x4 internal mini SAS connectors and four external SAS/SATA ports through one SFF-8087 x4 external mini SAS connector.

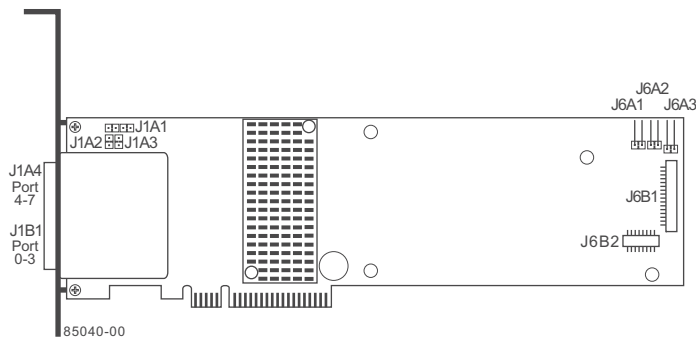
#### 3.1.8.1 MegaRAID SAS 9280-8e and SAS 9280DE-8e RAID Controllers – Board Layout and Jumper/Connector Information

This subsection provides the board layout and the connector information for the MegaRAID SAS 9280DE-8e RAID controller and the MegaRAID SAS 9280-8e RAID controller.

The following figure shows the jumpers and the connectors on these RAID controllers.

**NOTE** The MegaRAID SAS 9280DE-8e RAID controller has the same connectors as the MegaRAID SAS 9280-8e RAID controller.

**Figure 19 Card Layout for the MegaRAID SAS 9280-8e RAID Controller**



**NOTE** The J6A1, J6A2, and J6A3 connectors are behind the iBBU unit when the unit is installed, but are still accessible.

The following table describes the jumpers and connectors on the MegaRAID SAS 9280-8e RAID controller and the MegaRAID SAS 9280DE-8e RAID controller.

**Table 13 MegaRAID SAS 9280-8e and MegaRAID SAS 9280DE-8e RAID Controllers – Connectors**

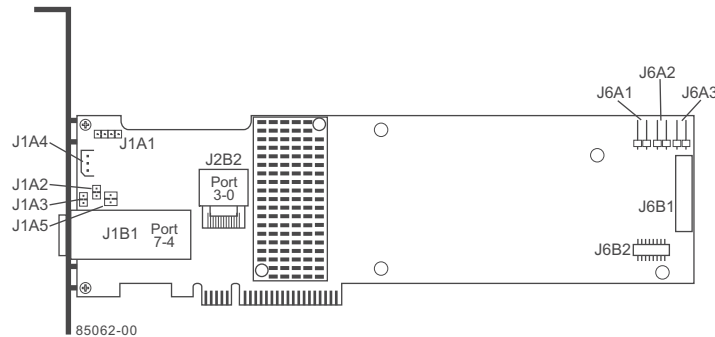
Connector	Description	Comments
J1A1	Universal Asynchronous Receiver/Transmitter (UART) debugging	4-pin connector Reserved for LSI use.
J1A2	Test header	2-pin connector Reserved for LSI use.
J1A3	Set Factory Defaults connector	2-pin connector Reserved for LSI use.
J1A4	x4 SAS Ports 4 to 7	SFF-8088 x4 external mini SAS connector Connects the cables from the controller to SAS drives or SATA drives or a SAS expander.
J1B1	x4 SAS Ports 0 to 3	SFF-8088 x4 external mini SAS connector Connects the cables from the controller to SAS drives or SATA drives or a SAS expander.
J6A1	Global Drive Fault LED header	2-pin connector Connects to an LED that indicates whether a drive is in a fault condition.
J6A2	SAS Activity LED header	2-pin connector Connects to an LED that indicates drive activity.
J6A3	Write-Pending Indicator (dirty cache) LED connector	2-pin connector Connects to an LED that indicates when the data in the cache has yet to be written to the storage devices. Used when the write-back feature is enabled.
J6B1	Remote Battery Backup Unit connector	20-pin connector Connects an optional remote LSIiBBU07 intelligent Battery Backup Unit or an LSIiBBU08 unit to the RAID controller.
J6B2	Battery Backup Unit connector	20-pin connector Connects an LSIiBBU07 intelligent Battery Backup Unit or an LSIiBBU08 unit directly to the RAID controller.

### 3.1.8.2 MegaRAID SAS 9280-4i4e RAID Controller – Board Layout and Jumper/Connector Information

This subsection provides the board layout and the connector information for the MegaRAID SAS 9280-4i4e RAID controller.

The following figure shows the jumpers and the connectors on the MegaRAID SAS 9280-4i4e controller.

**Figure 20 Card Layout for the MegaRAID SAS 9280-4i4e RAID Controller**



**NOTE** The J6A1, J6A2, and J6A3 connectors are behind the iBBU unit when the unit is installed, but are still accessible.

The following table describes the jumpers and the connectors on the MegaRAID SAS 9280-4i4e RAID controller.

**Table 14 MegaRAID SAS 9280-4i4e RAID Controller – Connectors**

Connector	Description	Comments
J1A1	Universal Asynchronous Receiver/Transmitter (UART) debugging	4-pin connector Reserved for LSI use.
J1A2	LSI Test header	2-pin connector Reserved for LSI use.
J1A3	Set Factory Defaults connector	2-pin connector Reserved for LSI use.
J1A4	IPMI-style I <sup>2</sup> C connector	3-pin connector. Supports SES (SCSI Enclosure Services) over I <sup>2</sup> C over an internal I <sup>2</sup> C backplane cable.
J1A5	Advanced Software Options Hardware Key header	2-pin shielded header Enables support for the Advanced Software Options features, which include CacheCade, Recovery, and SafeStore disk encryption. <b>NOTE</b> FastPath is now a standard feature for this controller.
J1B1	x4 SAS Ports 7 to 4	SFF-8088 x4 external mini SAS connector Connects the controller by cable to SAS drives, SATA drives, or a SAS expander.
J2B1	Standard Edge Card connector	The RAID controller interfaces with the host system through a standard edge card x8 PCIe 2.0 bus connection as defined in the PCIe specification. This interface provides power to the board and to an I <sup>2</sup> C interface connected to I <sup>2</sup> C bus one for IPMI.
J2B2	x4 SAS Ports 3 to 0	SFF-8087 x4 internal mini SAS connector Connects to an LED that indicates whether a drive is in a fault condition.
J6A1	Global Drive Fault LED header	2-pin connector Connects to an LED that indicates whether a drive is in a fault condition.

**Table 14 MegaRAID SAS 9280-4i4e RAID Controller – Connectors (Continued)**

Connector	Description	Comments
J6A2	SAS Activity LED header	2-pin connector Connects to an LED that indicates drive activity.
J6A3	Write-Pending Indicator (dirty cache) LED connector	2-pin connector Connects to an LED that indicates when the data in the cache has yet to be written to the storage devices. Used when the write-back feature is enabled.
J6B1	Remote Battery Backup Unit connector	20-pin connector Connects a remote optional LSIiBBU07 intelligent Battery Backup Unit or a remote LSIiBBU08 unit to the RAID controller.
J6B2	Battery Backup Unit connector	20-pin connector Connects an optional LSIiBBU07 intelligent Battery Backup Unit or an optional LSIiBBU08 unit to the RAID controller remotely.

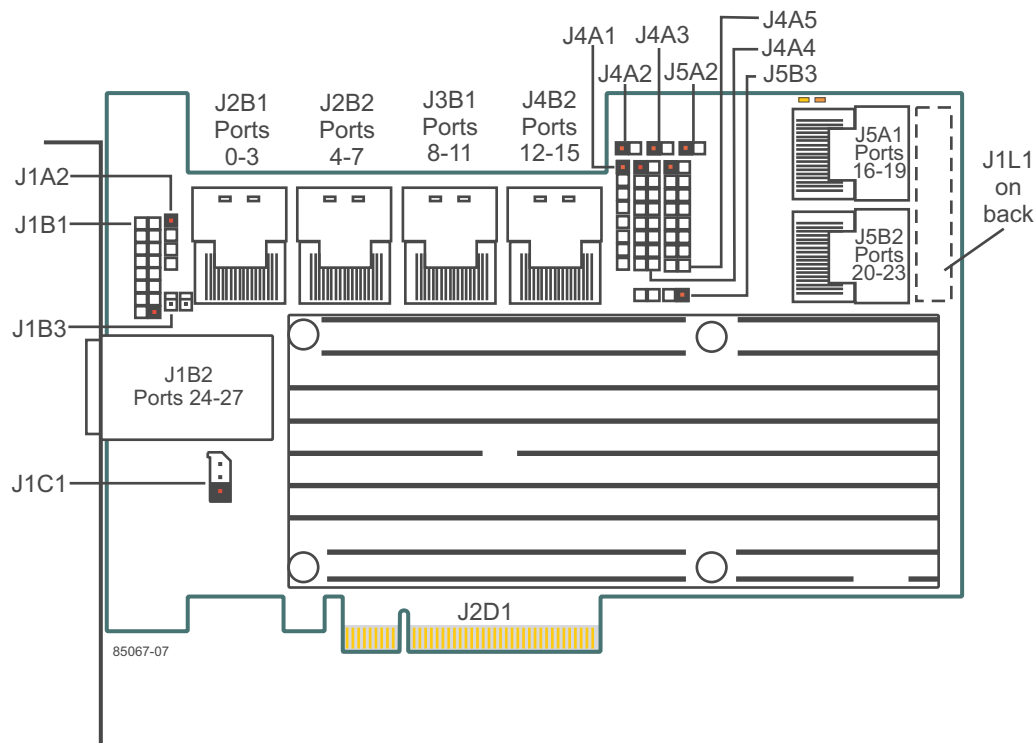
**NOTE** The J6A1, J6A2, and J6A3 connectors are behind the LSIiBBU07 unit when the iBBU unit is installed, but are still accessible.

**3.1.8.3 MegaRAID SAS 9280-16i4e and MegaRAID SAS 9280-24i4e RAID Controllers – Board Layout and Jumper/Connector Information**

This subsection provides the board layout and the connector information for the MegaRAID SAS 9280-16i4e RAID controller and the MegaRAID SAS 9280-24i4e RAID controller.

The following figure shows the jumpers and the connectors on the MegaRAID SAS 9280-24i4e controller.

**Figure 21 Card Layout for the MegaRAID SAS 9280-24i4e RAID Controller**

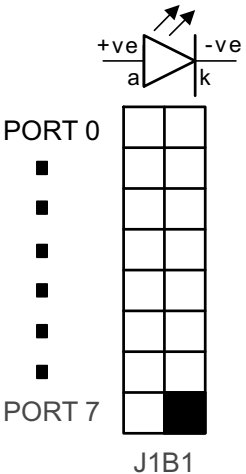


**NOTE** Pin 1 on the headers and connectors is highlighted in red in this figure.

**NOTE** The MegaRAID SAS 9280-16i4e RAID controller is like the MegaRAID SAS 9280-24i4e RAID controller except that the MegaRAID SAS 9280-16i4e controller does not contain the J4A5, J5A1, or J5B2 connectors.

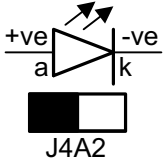
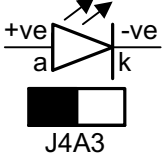
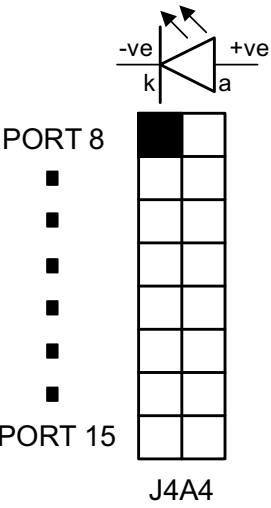
The following table describes the jumpers and the connectors on the MegaRAID SAS 9280-24i4e RAID controller. It includes diagrams showing Pin1 and its orientation for several of the connectors.

**Table 15 MegaRAID SAS 9280-24i4e RAID Controller – Connectors**

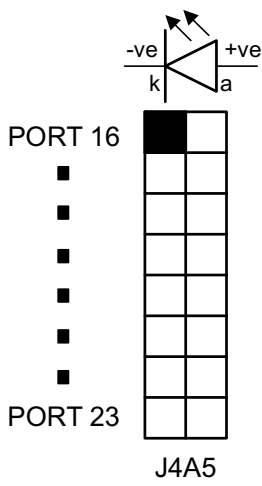
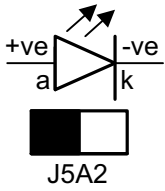
Jumper/ Connector	Type	Description
J1A2	Universal Asynchronous Receiver/Transmitter (UART) for the expander	4-pin connector Reserved for LSI use.
J1B1	LED Locate and Fault Indication header Ports 0 to 3 Ports 4 to 7 	2x8-pin connector Connects to an LED array that indicates whether a drive is in a fault condition. There is one LED per port. When lit, each LED indicates the corresponding drive has failed or is in the Unconfigured-Bad state. The LEDs function in a direct-attach configuration (there are no SAS expanders). Direct attach is defined as a maximum of one drive connected directly to each port. <b>NOTE</b> This header is used for RAID controllers with internal SAS ports only.
J1B2	x4 SAS Ports 24 to 27 External connector	SFF-8088 x4 external mini SAS connector Connects the controller by cable to a SAS/SATA backplane or an expander.
J1B3	Advanced Software Options Hardware Key header	2-pin header Enables support for the Advanced Software Options features, which include CacheCade, Recovery, and SafeStore disk encryption. <b>NOTE</b> FastPath is now a standard feature for this controller.
J1C1	IPMI-style I <sup>2</sup> C connector	3-pin connector Supports SES (SCSI enclosure services) over I <sup>2</sup> C through an internal I <sup>2</sup> C backplane cable.
J1L1	Remote Battery Backup connector (on the rear of the controller)	20-pin connector Connects an optional remote LSiBBU07 intelligent Battery Backup Unit or an LSiBBU08 unit to the RAID controller.
J2B1	x4 SAS Ports 0 to 3 Internal connector	SFF-8087 x4 internal mini SAS connector Connects the controller by cable to SAS drives or SATA 2 drives.
J2B2	x4 SAS Ports 4 to 7 Internal connector	SFF-8087 x4 internal mini SAS connector Connects the controller by cable to SAS drives or SATA 2 drives.



**Table 15 MegaRAID SAS 9280-24i4e RAID Controller – Connectors (Continued)**

Jumper/ Connector	Type	Description
J2D1	Standard Edge Card connector	The RAID controller interfaces with the host system through a standard edge card.  This interface provides power to the board and an I <sup>2</sup> C interface connected to the I <sup>2</sup> C bus for IPMI.
J3B1	x4 SAS Ports 8 to 11 internal connector	SFF-8087 x4 internal mini SAS connector Connects the controller by cable to SAS drives or SATA drives.
J4A1	Module CPLD	1x8-pin connector Reserved for LSI use.
J4A2	Activity LED header 	2-pin connector Connects to an LED that indicates activity on the drives connected to the controller.
J4A3	Global Drive Fault LED header 	2-pin connector Connects to an LED that indicates whether a drive is in a fault condition.
J4A4	LED Locate and Fault Indication header Ports 8 to 11 Ports 12 to 15 	2x8-pin header Connects to an LED array that indicates whether a drive is in a fault condition. There is one LED per port. When lit, each LED indicates the corresponding drive has failed or is in the Unconfigured-Bad state.  The LEDs function in a direct-attach configuration (there are no SAS expanders). Direct attach is defined as a maximum of one drive connected directly to each port.  <b>NOTE</b> This header is used for RAID controllers with internal SAS ports only.

**Table 15 MegaRAID SAS 9280-24i4e RAID Controller – Connectors (Continued)**

Jumper/ Connector	Type	Description
J4A5	LED Locate and Fault Indication header Ports 16 to 19 Ports 20 to 23  	2x8-pin header Connects to an LED array that indicates whether a drive is in a fault condition. There is one LED per port. When lit, each LED indicates the corresponding drive has failed or is in the Unconfigured-Bad state. The LEDs function in a direct-attach configuration (there are no SAS expanders). Direct-attach is defined as a maximum of one drive connected directly to each port. <b>NOTE</b> This header is used for RAID controllers with internal SAS ports only.
J4B2	x4 SAS Ports 12 to 15 Internal connector	SFF-8087 x4 internal mini SAS connector Connects the controller by cable to SAS drives or SATA 2 drives.
J5A1	x4 SAS Ports 16 to 19 Internal connector	SFF-8087 x4 internal mini SAS connector Connects the controller by cable to SAS drives or SATA 2 drives.
J5A2	Write-Pending LED header  	2-pin connector Connects to an LED that indicates when the data in the cache has yet to be written to the storage devices. Used when the write-back feature is enabled.
J5B2	x4 SAS Ports 20 to 23 Internal connector	SFF-8087 x4 internal mini SAS connector Connects the controller by cable to SAS drives or SATA 2 drives.
J5B3	Universal Asynchronous Receiver/Transmitter (UART) debugging	4-pin connector Reserved for LSI use.

### 3.1.9 MegaRAID SAS 9285 RAID Controllers

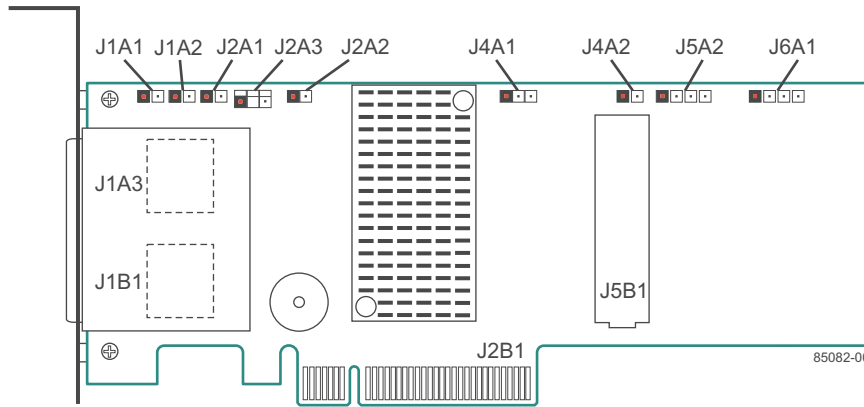
The MegaRAID SAS 9285-8e low-profile SAS/SATA RAID controller controls eight external SAS/SATA ports through two SFF-8088 x4 external mini SAS connectors.

The MegaRAID SAS 9285CV-8e low-profile SAS/SATA RAID controller controls eight external SAS/SATA ports through two SFF-8088 x4 external mini SAS connectors. This controller supports the CVFM03 onboard 1-GB nonvolatile DDR3 1333MT/s CacheVault Flash Module 03, which connects to a remote CacheVault Power Module 02 to provide backup for your data in case of power loss.

### 3.1.9.1 MegaRAID SAS 9285-8e RAID Controller – Board Layout and Jumper/Connector Information

This subsection provides the board layout and the connector information for the MegaRAID SAS 9285-8e RAID controller. The following figure shows the location of the jumpers and the connectors on the MegaRAID SAS 9285-8e RAID controller. The jumpers are set at the factory, and you usually do not need to change them.

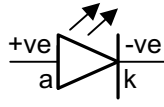

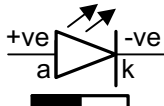

**Figure 22 Card Layout for the MegaRAID SAS 9285-8e RAID Controller**



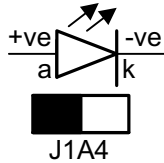
**NOTE** Pin 1 on the headers and connectors is highlighted in red in this figure.

The following table describes the jumpers and the connectors on the MegaRAID SAS 9285-8e RAID controller.

**Table 16 MegaRAID SAS 9285-8e RAID Controller – Connectors**

Jumper/Connector	Type	Description
J1A1	Write-Pending LED header   J1A1	2-pin connector Connects to an LED that indicates when the data in the cache has yet to be written to the storage devices. Used when the write-back feature is enabled.
J1A2	Global Drive Fault LED header   J1A2	2-pin connector Connects to an LED that indicates whether a drive is in a fault condition.
J1A3	x4 SAS Ports 4 to 7 External connector	SFF-8088 x4 external mini SAS connector Connects the controller by cable to SAS drives or SATA drives.
J1B1	x4 SAS Ports 0 to 3 External connector	SFF-8088 x4 external mini SAS connector Connects the controller by cable to SAS drives or SATA drives.

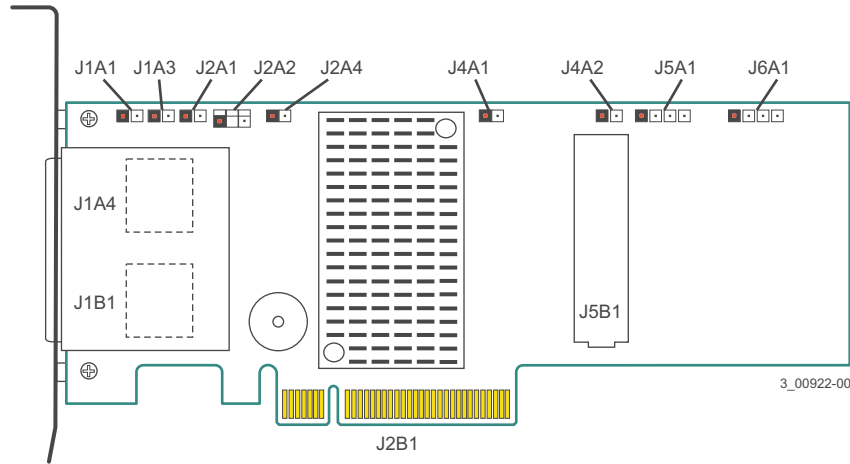
**Table 16 MegaRAID SAS 9285-8e RAID Controller – Connectors (Continued)**

Jumper/ Connector	Type	Description
J2A1	Activity LED header 	2-pin connector Connects to an LED that indicates activity on the drives connected to the controller.
J2A2	I <sup>2</sup> O Mode jumper	2-pin connector Installing this jumper causes the RAID controller to run in I <sup>2</sup> O mode. The default mode of operation is without the shunt and running in Fusion mode.
J2A3	Advanced Software Options Hardware Key header	3-pin header Enables support for the Advanced Software Options features, which include CacheCade, Recovery, and SafeStore disk encryption. <b>NOTE</b> FastPath is now a standard feature for this controller.
J2B1	Standard Edge Card connector	The RAID controller interfaces with the host system through a standard edge card. This interface provides power to the board and an I <sup>2</sup> C interface connected to the I <sup>2</sup> C bus for IPMI.
J4A1	Serial EEPROM	2-pin connector Provides controller information, such as the serial number, revision, and manufacturing date. The default is no shunt installed.
J4A2	LSI Test header	2-pin connector Reserved for LSI use.
J5A2	Serial Universal Asynchronous Receiver/Transmitter (UART) connector for the expander	4-pin connector Reserved for LSI use.
J5B1	Board-to-board Mezzanine connector	240-pin 02 DDR3 nonvolatile memory module interface Connects the memory module directly to the RAID controller. The module connects to an LSiBBU09 Battery Backup Unit that is mounted remotely. Refer to the <i>MegaRAID LSiBBU09 Intelligent Battery Backup Unit 09 Quick Installation Guide</i> for the procedure used to connect the memory module to the remote LSiBBU09 unit.
J6A1	Serial Universal Asynchronous Receiver/Transmitter (UART) connector for the expander	4-pin connector Reserved for LSI use.

### 3.1.9.2 MegaRAID SAS 9285CV-8e RAID Controller – Board Layout and Jumper/Connector Information

This subsection provides the board layout and the connector information for the MegaRAID SAS 9285CV-8e RAID controller. The following figure shows the location of the jumpers and the connectors on the MegaRAID SAS 9285CV-8e RAID controller. The jumpers are set at the factory, and you usually do not need to change them.

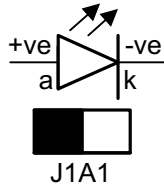
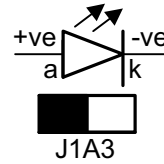
**Figure 23 Card Layout for the MegaRAID SAS 9285CV-8e RAID Controller**



**NOTE** Pin 1 on the headers and connectors is highlighted in red in this figure.

The following table describes the connectors on the MegaRAID SAS 9285CV-8e RAID controller.

**Table 17 MegaRAID SAS 9285CV-8e RAID Controller – Connectors**

Jumper/Connector	Type	Description
J1A1	Write-Pending LED header 	2-pin connector Connects to an LED that indicates when the data in the cache has yet to be written to the storage devices. Used when the write-back feature is enabled.
J1A3	Global Drive Fault LED header 	2-pin connector Connects to an LED that indicates whether a drive is in a fault condition.
J1A4	x4 SAS Ports 4 to 7 External connector	SFF-8088 x4 external mini SAS connector Connects the controller by cable to SAS drives or SATA drives.
J1B1	x4 SAS Ports 0 to 3 External connector	SFF-8088 x4 external mini SAS connector Connects the controller by cable to SAS drives or SATA drives.

**Table 17 MegaRAID SAS 9285CV-8e RAID Controller – Connectors (Continued)**

Jumper/ Connector	Type	Description
J2A1	Activity LED header	2-pin connector Connects to an LED that indicates activity on the drives connected to the controller.
J2A2	Advanced Software Options Hardware Key header	3-pin header Enables support for the Advanced Software Options features, which include CacheCade, Recovery, and SafeStore disk encryption. <b>NOTE</b> FastPath is now a standard feature for this controller.
J2A4	I <sup>2</sup> O Mode jumper	2-pin connector Installing this jumper causes the RAID controller to run in I <sup>2</sup> O mode. The default mode of operation is without the shunt and running in Fusion mode.
J2B1	Standard Edge Card connector	The RAID controller interfaces with the host system through a standard edge card. This interface provides power to the board and an I <sup>2</sup> C interface connected to the I <sup>2</sup> C bus for IPMI.
J4A1	Serial EEPROM	2-pin connector Provides controller information, such as the serial number, revision, and manufacturing date. The default is no shunt installed.
J4A2	LSI Test header	2-pin connector Reserved for LSI use.
J5A1	Serial Universal Asynchronous Receiver/Transmitter (UART) connector for the expander	4-pin connector Reserved for LSI use.
J5B1	DDR3 Board-to-Board Mezzanine connector	240-pin DDR3 nonvolatile memory module interface Connects the controller directly to a CVFM02 module. The CVFM02 module connects to a remote CVPM02 module. Refer to the <i>MegaRAID CacheVault Flash Module 02 Quick Installation Guide</i> for the procedure used to connect a CVFM02 module to a remote CVPM02 module.
J6A1	Serial Universal Asynchronous Receiver/Transmitter (UART) connector for the expander	4-pin connector Reserved for LSI use.

### 3.1.10 MegaRAID SAS 9286 RAID Controllers

The MegaRAID SAS 9286-8e low-profile SAS/SATA RAID controller controls eight external SAS/SATA ports through two SFF-8088 x4 external mini SAS connectors.

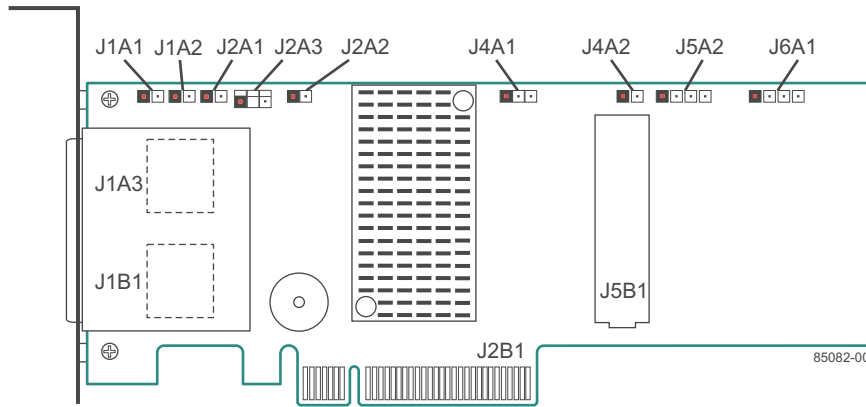
The MegaRAID SAS 9286CV-8e low-profile SAS/SATA RAID controller controls eight external SAS/SATA ports through two SFF-8088 x4 external mini SAS connectors. This controller supports the CVFM03 onboard 1-GB nonvolatile DDR3 1333MT/s CacheVault Flash Module 03, which connects to a remote CacheVault Power Module 02 to provide backup for your data in case of power loss.

The MegaRAID SAS 9286CV-8iCC RAID controller controls eight internal SAS+SATA ports through two SFF-8087 mini SAS 4i internal connectors. This controller supports the CVFM03 onboard 1-GB nonvolatile DDR3 1333MT/s CacheVault Flash Module 03, which connects to a remote CacheVault Power Module 02 to provide backup for your data in case of power loss. This RAID controller ships as standard with CacheCade (CC) Pro 2.0 and Fast Path software enabled out of the box.

### 3.1.10.1 MegaRAID SAS 9286-8e RAID Controller – Board Layout and Jumper/Connector Information

This subsection provides the board layout and the connector information for the MegaRAID SAS 9286-8e RAID controller. The following figure shows the location of the jumpers and the connectors on the MegaRAID SAS 9286-8e RAID controller. The jumpers are set at the factory, and you usually do not need to change them.

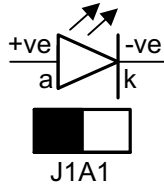
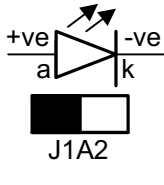
**Figure 24 Card Layout for the MegaRAID SAS 9286-8e RAID Controller**



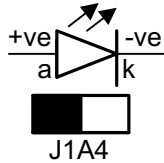
**NOTE** Pin 1 on the headers and connectors is highlighted in red in this figure.

The following table describes the jumpers and the connectors on the MegaRAID SAS 9286-8e RAID controller.

**Table 18 MegaRAID SAS 9286-8e RAID Controller – Connectors**

Jumper/Connector	Type	Description
J1A1	Write-Pending LED header  J1A1	2-pin connector Connects to an LED that indicates when the data in the cache has yet to be written to the storage devices. Used when the write-back feature is enabled.
J1A2	Global Drive Fault LED header  J1A2	2-pin connector Connects to an LED that indicates whether a drive is in a fault condition.
J1A3	x4 SAS Ports 4 to 7 External connector	SFF-8088 x4 external mini SAS connector Connects the controller by cable to SAS drives or SATA drives.
J1B1	x4 SAS Ports 0 to 3 External connector	SFF-8088 x4 external mini SAS connector Connects the controller by cable to SAS drives or SATA drives.

**Table 18 MegaRAID SAS 9286-8e RAID Controller – Connectors (Continued)**

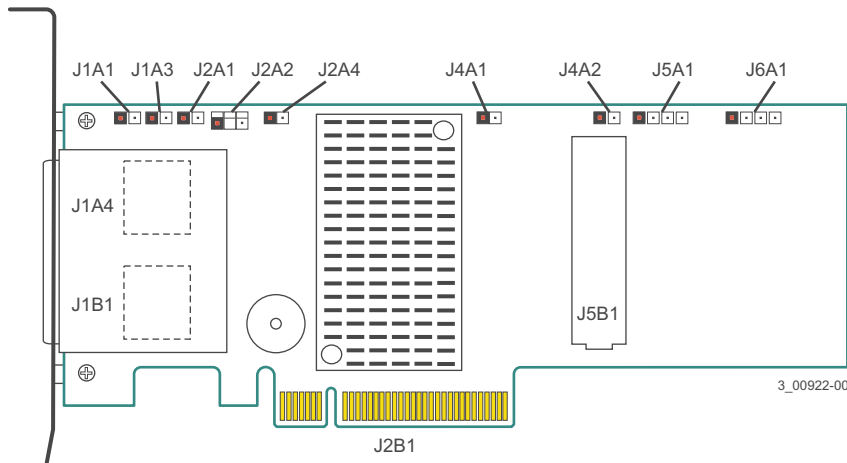
Jumper/ Connector	Type	Description
J2A1	Activity LED header 	2-pin connector Connects to an LED that indicates activity on the drives connected to the controller.
J2A2	I <sup>2</sup> O Mode jumper	2-pin connector Installing this jumper causes the RAID controller to run in I <sup>2</sup> O mode. The default mode of operation is without the shunt and running in Fusion Mode.
J2A3	Advanced Software Options Hardware Key header	3-pin header Enables support for the Advanced Software Options features, which include CacheCade, Recovery, and SafeStore disk encryption. <b>NOTE</b> FastPath is now a standard feature for this controller.
J2B1	Standard Edge Card connector	The RAID controller interfaces with the host system through a standard edge card. This interface provides power to the board and an I <sup>2</sup> C interface connected to the I <sup>2</sup> C bus for IPMI.
J4A1	Serial EEPROM	2-pin connector Provides controller information, such as the serial number, revision, and manufacturing date. The default is no shunt installed.
J4A2	LSI Test header	2-pin connector Reserved for LSI use.
J5A2	Serial Universal Asynchronous Receiver/Transmitter (UART) connector for the expander	4-pin connector Reserved for LSI use.
J5B1	Board-to-board Mezzanine connector	240-pin 02 DDR3 nonvolatile memory module interface Connects the memory module directly to the RAID controller. The module connects to an LSiBBU09 Battery Backup Unit that is mounted remotely. Refer to the <i>MegaRAID LSiBBU09 Intelligent Battery Backup Unit 09 Quick Installation Guide</i> for the procedure used to connect the memory module to the remote LSiBBU09 unit.
J6A1	Serial Universal Asynchronous Receiver/Transmitter (UART) connector for the expander	4-pin connector Reserved for LSI use.



### 3.1.10.2 MegaRAID SAS 9286CV-8e RAID Controller – Board Layout and Jumper/Connector Information

This subsection provides the board layout and the connector information for the MegaRAID SAS 9286CV-8e RAID controller. The following figure shows the location of the jumpers and the connectors on the MegaRAID SAS 9286CV-8e RAID controller. The jumpers are set at the factory, and you usually do not need to change them.

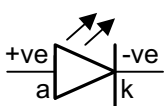

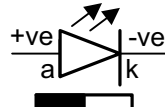
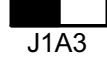
**Figure 25 Card Layout for the MegaRAID SAS 9286CV-8e RAID Controller**



**NOTE** Pin 1 on the headers and connectors is highlighted in red in this figure.

The following table describes the connectors on the MegaRAID SAS 9286CV-8e RAID controller.

**Table 19 MegaRAID SAS 9286CV-8e RAID Controller – Connectors**

Jumper/Connector	Type	Description
J1A1	Write-Pending LED header   J1A1	2-pin connector Connects to an LED that indicates when the data in the cache has yet to be written to the storage devices. Used when the write-back feature is enabled.
J1A3	Global Drive Fault LED header   J1A3	2-pin connector Connects to an LED that indicates whether a drive is in a fault condition.
J1A4	x4 SAS Ports 4 to 7 External connector	SFF-8088 x4 external mini SAS connector Connects the controller by cable to SAS drives or SATA drives.

**Table 19 MegaRAID SAS 9286CV-8e RAID Controller – Connectors (Continued)**

Jumper/ Connector	Type	Description
J1B1	x4 SAS Ports 0 to 3 External connector	SFF-8088 x4 external mini SAS connector Connects the controller by cable to SAS drives or SATA drives.
J2A1	Activity LED header	2-pin connector Connects to an LED that indicates activity on the drives connected to the controller.
J2A2	Advanced Software Options Hardware Key header	3-pin header Enables support for the Advanced Software Options features, which include CacheCade, Recovery, and SafeStore disk encryption. <b>NOTE</b> FastPath is now a standard feature for this controller.
J2A4	I <sup>2</sup> O Mode jumper	2-pin connector Installing this jumper causes the RAID controller to run in I <sup>2</sup> O mode. The default mode of operation is without the shunt and running in Fusion mode.
J2B1	Standard Edge Card connector	The RAID controller interfaces with the host system through a standard edge card. This interface provides power to the board and an I <sup>2</sup> C interface connected to the I <sup>2</sup> C bus for IPMI.
J4A1	Serial EEPROM	2-pin connector Provides controller information, such as the serial number, revision, and manufacturing date. The default is no shunt installed.
J4A2	LSI Test header	2-pin connector Reserved for LSI use.
J5A1	Serial Universal Asynchronous Receiver/Transmitter (UART) connector for the expander	4-pin connector Reserved for LSI use.
J5B1	DDR3 Board-to-Board Mezzanine connector	240-pin DDR3 nonvolatile memory module interface Connects the controller directly to a CVFM02 module. The CVFM02 module connects to a remote CVPM02 module. Refer to the <i>MegaRAID CacheVault Flash Module 02 Quick Installation Guide</i> for the procedure used to connect a CVFM02 module to a remote CVPM02 module.
J6A1	Serial Universal Asynchronous Receiver/Transmitter (UART) connector for the expander	4-pin connector Reserved for LSI use.

## 3.2 MegaRAID SAS 6Gb/s RAID Controller Characteristics

The following table shows the general characteristics for all of the 6Gb/s MegaRAID SAS RAID controllers.

**Table 20 6Gb/s MegaRAID SAS RAID Controller Characteristics**

Flash ROM <sup>a</sup>	Serial EEPROM <sup>b</sup>	Data Transfer Rates	SCSI Features	SCSI Termination
Yes	Yes	Up to 6Gb/s per port for SAS and up to 6Gb/s per port for SATA III	Plug-and-Play Scatter/Gather Activity LED	Active

- a. For boot code and firmware.
- b. For BIOS configuration storage.

Each 6Gb/s MegaRAID SAS RAID controller ensures data integrity by intelligently validating the compatibility of the SAS domain. The 6Gb/s MegaRAID SAS RAID controllers use Fusion-MPT architecture, which allows for thinner drivers and better performance.

## 3.3 Technical Specifications

The design and implementation of the 6Gb/s MegaRAID SAS RAID controllers minimize electromagnetic emissions, susceptibility to radio frequency energy, and the effects of electrostatic discharge. The 6Gb/s MegaRAID SAS RAID controllers show the following marks and certifications:

- CE mark
- C-Tick mark
- FCC Self-Certification logo
- Canadian Compliance Statement
- Korean MIC
- Taiwan BSMI
- Japan VCCI
- CISPR Class B

The following hardware is compliant with CSA C22.2 No. 60950-1, UL 60950-1 First Edition-listed accessory, UL file number E257743:

- MegaRAID SAS 9240-4i RAID controller (model 25083)
- MegaRAID SAS 9240-8i RAID controller (model 25091)
- MegaRAID SAS 9260-4i RAID controller (model 25121-45A)
- MegaRAID SAS 9260-8i RAID controller (model 25121-44)
- MegaRAID SAS 9260-16i RAID controller (model 25243-06)
- MegaRAID SAS 9260CV-4i RAID controller (model 25377-00)
- MegaRAID SAS 9260CV-8i RAID controller (model 25377-00)
- MegaRAID SAS 9260DE-8i RAID controller (model 25121)
- MegaRAID SAS 9261-8i RAID controller (model 25239)
- MegaRAID SAS 9265-8i RAID controller (model 25366-00)
- MegaRAID SAS 9265CV-8i RAID controller (model 25422-00)
- MegaRAID SAS 9266-4i RAID controller (model 25413-00)

- 
- MegaRAID SAS 9266-8i RAID controller (model 25413-00)
  - MegaRAID SAS 9270-8i RAID controller (model 25422)
  - MegaRAID SAS 9271-4i RAID controller (model 25413)
  - MegaRAID SAS 9271-8i RAID controller (model 25413)
  - MegaRAID SAS 9271-8iCC RAID controller (model 25413)
  - MegaRAID SAS 9280-4i4e RAID controller (model 25305)
  - MegaRAID SAS 9280-8e RAID controller (model 25152)
  - MegaRAID SAS 9280DE-8e RAID controller (model 25152)
  - MegaRAID SAS 9280-16i4e RAID controller (model 25243)
  - MegaRAID SAS 9280-24i4e RAID controller (model 25243)
  - MegaRAID SAS 9285-8e RAID controller (model 25367)
  - MegaRAID SAS 9285CV-8e RAID controller (model 25421)
  - MegaRAID SAS 9286-8e RAID controller (model 25421)
  - MegaRAID SAS 9286CV-8e RAID controller (model 25421)
  - MegaRAID SAS 9286CV-8eCC RAID controller (model 25421)
  - CacheVault Flash Module 01 (model CVFM01)
  - CacheVault Flash Module 02 (model CVFM02)
  - CacheVault Flash Module 03 (model CVFM03)
  - CacheVault Power Module 01 (model CVPM01)
  - CacheVault Power Module 02 (model CVPM02)
  - LSI intelligent battery backup unit 07 (model 25034)
  - LSI intelligent battery backup unit 08 (model 25343)
  - LSI intelligent battery backup unit 09 (model 25407)

### 3.3.1 RAID Controller Specifications

The following table lists the specifications for the 6Gb/s MegaRAID SAS RAID controllers.

**Table 21 RAID Controller Specifications**

Specification	<b>MegaRAID SAS 9240, SAS 9260, SAS 9261, SAS 9265, SAS 9266, SAS 9270, SAS 9271, SAS 9280, SAS 9285, and SAS 9286 RAID Controllers</b>
Processor (PCIe host controller to PCI secondary I/O controller)	MegaRAID SAS 9240 RAID controllers: LSISAS2008 PCIe-SAS/SATA I/O Processor chip MegaRAID SAS 9260, SAS 9261, and SAS 9280 RAID controllers: LSISAS2108 ROC device with an Integrated PowerPC® processor made by IBM MegaRAID SAS 9265, SAS 9266, SAS 9270, SAS 9271, SAS 9285, and SAS 9286 RAID controllers: LSISAS2208 ROC device
Part number	<ul style="list-style-type: none"> <li>■ MegaRAID SAS 9240-4i RAID controller: 25083</li> <li>■ MegaRAID SAS 9240-8i RAID controller: 25091</li> <li>■ MegaRAID SAS 9260-4i RAID controller: 25121</li> <li>■ MegaRAID SAS 9260-8i RAID controller: 25121</li> <li>■ MegaRAID SAS 9260-16i RAID controller: 25243-06</li> <li>■ MegaRAID SAS 9260CV-4i RAID controller: 25377-00</li> <li>■ MegaRAID SAS 9260CV-8i RAID controller: 25377-00</li> <li>■ MegaRAID SAS 9260DE-8i RAID controller: 25121</li> <li>■ MegaRAID SAS 9261-8i RAID controller: 25239</li> <li>■ MegaRAID SAS 9265-8i RAID controller: 25366</li> <li>■ MegaRAID SAS 9265CV-8i RAID controller: 25422</li> <li>■ MegaRAID SAS 9266-4i RAID controller: 25413</li> <li>■ MegaRAID SAS 9266-8i RAID controller: 25413</li> <li>■ MegaRAID SAS 9270-8i RAID controller: 25422</li> <li>■ MegaRAID SAS 9271-4i RAID controller: 25413</li> <li>■ MegaRAID SAS 9271-8i RAID controller: 25413</li> <li>■ MegaRAID SAS 9271-8iCC RAID controller: 25413</li> <li>■ MegaRAID SAS 9280-4i4e RAID controller: 25305</li> <li>■ MegaRAID SAS 9280-8e RAID controller: 25152</li> <li>■ MegaRAID SAS 9280DE-8e RAID controller: 25152</li> <li>■ MegaRAID SAS 9280-16i4e RAID controller: 25243-07</li> <li>■ MegaRAID SAS 9280-24i4e RAID controller: 25243-05</li> <li>■ MegaRAID SAS 9285-8e RAID controller: 25367</li> <li>■ MegaRAID SAS 9285CV-8e RAID controller: 25421</li> <li>■ MegaRAID SAS 9286-8e RAID controller: 25421</li> <li>■ MegaRAID SAS 9286CV-8e RAID controller: 25421</li> <li>■ MegaRAID SAS 9286CV-8eCC RAID controller: 25421</li> </ul>
Operating voltage	+3.3 V, +12 V

**Table 21 RAID Controller Specifications (Continued)**

Specification	<b>MegaRAID SAS 9240, SAS 9260, SAS 9261, SAS 9265, SAS 9266, SAS 9270, SAS 9271, SAS 9280, SAS 9285, and SAS 9286 RAID Controllers</b>
Card size	<ul style="list-style-type: none"> <li>■ MegaRAID SAS 9240-4i RAID controller: Low-profile PCIe adapter card size (68.90 mm × 167.65 mm)</li> <li>■ MegaRAID SAS 9240-8i RAID controller: Low-profile PCIe adapter card size (68.90 mm × 167.65 mm)</li> <li>■ MegaRAID SAS 9260-4i RAID controller: Low-profile PCIe adapter card size (68.90 mm × 167.65 mm)</li> <li>■ MegaRAID SAS 9260-8i RAID controller: Low-profile PCIe adapter card size (68.90 mm × 167.65 mm)</li> <li>■ MegaRAID SAS 9260-16i RAID controller: Standard-height PCIe adapter card size (111.15 mm × 167.64 mm)</li> <li>■ MegaRAID SAS 9260CV-4i RAID controller: Low-profile PCIe adapter card size (68.90 mm × 167.65 mm)</li> <li>■ MegaRAID SAS 9260CV-8i RAID controller: Low-profile PCIe adapter card size (68.90 mm × 167.65 mm)</li> <li>■ MegaRAID SAS 9260DE-8i RAID controller: Low-profile PCIe adapter card size (68.90 mm × 167.65 mm)</li> <li>■ MegaRAID SAS 9261-8i RAID controller: Low-profile PCIe adapter card size (68.90 mm × 167.65 mm)</li> <li>■ MegaRAID SAS 9265-8i RAID controller: Low-profile PCIe adapter card size (68.90 mm × 167.65 mm)</li> <li>■ MegaRAID SAS 9265CV-8i RAID controller: Low-profile PCIe adapter card size (68.90 mm × 167.65 mm)</li> <li>■ MegaRAID SAS 9266-4i RAID controller: Low-profile PCIe adapter card size (68.90 mm × 167.65 mm)</li> <li>■ MegaRAID SAS 9266-8i RAID controller: Low-profile PCIe adapter card size (68.90 mm × 167.65 mm)</li> <li>■ MegaRAID SAS 9270-8i RAID controller: Low-profile PCIe adapter card size (68.90 mm × 167.65 mm)</li> <li>■ MegaRAID SAS 9271-4i RAID controller: Low-profile PCIe adapter card size (68.90 mm × 167.65 mm)</li> <li>■ MegaRAID SAS 9271-8i RAID controller: Low-profile PCIe adapter card size (68.90 mm × 167.65 mm)</li> <li>■ MegaRAID SAS 9271-8iCC RAID controller: Low-profile PCIe adapter card size (68.90 mm × 167.65 mm)</li> <li>■ MegaRAID SAS 9280-4i4e RAID controller: Low-profile PCIe adapter card size (68.90 mm × 167.65 mm)</li> <li>■ MegaRAID SAS 9280-8e RAID controller: Low-profile PCIe adapter card size (68.90 mm × 167.65 mm)</li> <li>■ MegaRAID SAS 9280DE-8e RAID controller: Low-profile PCIe adapter card size (68.90 mm × 167.65 mm)</li> <li>■ MegaRAID SAS 9280-16i4e RAID controller: Standard-height PCIe adapter card size (111.15 mm × 167.64 mm)</li> <li>■ MegaRAID SAS 9280-24i4e RAID controller: Standard-height PCIe adapter card size (111.15 mm × 167.64 mm)</li> <li>■ MegaRAID SAS 9285-8e RAID controller: Low-profile PCIe adapter card size (68.90 mm × 167.65 mm)</li> <li>■ MegaRAID SAS 9285CV-8e RAID controller: Low-profile PCIe adapter card size (68.90 mm × 167.65 mm)</li> </ul>

**Table 21 RAID Controller Specifications (Continued)**

Specification	MegaRAID SAS 9240, SAS 9260, SAS 9261, SAS 9265, SAS 9266, SAS 9270, SAS 9271, SAS 9280, SAS 9285, and SAS 9286 RAID Controllers
Card size (continued)	<ul style="list-style-type: none"> <li>■ MegaRAID SAS 9286-8e RAID controller: Low-profile PCIe adapter card size (68.90 mm × 167.65 mm)</li> <li>■ MegaRAID SAS 9286CV-8e RAID controller: Low-profile PCIe adapter card size (68.90 mm × 167.65 mm)</li> <li>■ MegaRAID SAS 9286CV-8eCC RAID controller: Low-profile PCIe adapter card size (68.90 mm × 167.65 mm)</li> </ul>
Array interface to the host	<ul style="list-style-type: none"> <li>■ PCIe Rev. 2.0</li> <li>■ PCIe Rev. 3.0</li> </ul>
PCIe bus data transfer rate	<ul style="list-style-type: none"> <li>■ Up to 5 Gb/s per lane</li> <li>■ x8 lane width</li> </ul>
Serial port	4-pin RS232-compatible connector (for manufacturing use only)
SAS controller	<ul style="list-style-type: none"> <li>■ LSISAS2008 PCIe-SAS/SATA I/O Processor chip</li> <li>■ LSISAS2108 Single SAS controller</li> <li>■ LSISAS2208 SAS Interface controller</li> </ul>
SAS bus speed	6Gb/s
SAS ports	SAS connectors with four SAS ports each
Cache configuration	<p>The RAID controllers support the following battery-backed cache configuration:</p> <ul style="list-style-type: none"> <li>■ MegaRAID SAS 9260, SAS 9261, and SAS 9280: <ul style="list-style-type: none"> <li>— 512 MB – 72b arrangement (5) 1Gbx16, Double Data Rate II (DDR2) @ 800 MHz battery-backed module</li> </ul> </li> <li>■ MegaRAID SAS 9265, SAS 9266, and SAS 9285: <ul style="list-style-type: none"> <li>— 1 GB – 72b arrangement (5) 2Gbx16, Double Data Rate III (DDR3) @ 1333 MHz with iBBU support</li> </ul> </li> <li>■ MegaRAID SAS 9265CV, SAS 9266, and SAS 9285CV: <ul style="list-style-type: none"> <li>— 1 GB – 72b arrangement (5) 2Gbx16, Double Data Rate III (DDR3) @ 1333 MHz custom module with CacheVault support</li> </ul> </li> </ul> <p><b>NOTE</b> The MegaRAID SAS 9240-4i RAID controller and the MegaRAID SAS 9240-8i RAID controller are software RAID controllers and do not support cache.</p>
Size of flash ROM for firmware	16 MB
NVRAM	32 KB for storing RAID configurations

### 3.3.2 Array Performance Features

The following table shows the array performance features for the 6Gb/s MegaRAID SAS RAID controllers.

**Table 22 Array Performance Features**

Specification	MegaRAID SAS 9240, SAS 9260, SAS 9261, SAS 9265, SAS 9266, SAS 9270, SAS 9271, SAS 9280, SAS 9285, and SAS 9286 RAID Controllers
PCIe host data transfer rate	5Gb/s per lane
Drive data transfer rate	6Gb/s per lane
Maximum scatter/gather I/O	80 elements
Maximum size of I/O requests	6.4 MB in 64-KB strips
Maximum queue tags per drive	As many as the drive can accept
Strip sizes	8 KB, 16 KB, 32 KB, 64 KB, 128 KB, 256 KB, 512 KB, or 1 MB  <b>NOTE</b> RAID 0, 1, and 10 configurations for MegaRAID SAS 9240 RAID controllers are limited to 16 drives and 64K stripe size. To exceed these limitations, you can plug in a new MegaRAID SAS 9260 RAID controller or a new MegaRAID SAS 9280 RAID controller. The MegaRAID Storage Manager utility recognizes and imports the existing array with no reconfiguration required.
Maximum number of concurrent commands	255

### 3.3.3 Fault Tolerance

The following table lists the fault tolerance features for the 6Gb/s MegaRAID SAS RAID controllers.

**Table 23 Fault Tolerance Features**

Specification	MegaRAID SAS 9240, SAS 9260, SAS 9261, SAS 9265, SAS 9266, SAS 9280, and SAS 9285 RAID Controllers
Support for SMART <sup>™a</sup>	Yes
Drive failure detection	Automatic
Drive rebuild using hot spares	Automatic
Parity generation and checking	Yes

- a. The Self Monitoring Analysis and Reporting Technology (SMART) detects up to 70 percent of all predictable drive failures. In addition, SMART monitors the internal performance of all motors, heads, and drive electronics.



### 3.3.4 Electrical Characteristics and Environmental Conditions

This subsection provides the power supply requirements, and the operating (thermal and atmospheric) and non-operating conditions, for the 6Gb/s MegaRAID SAS RAID controllers.

#### 3.3.4.1 Power Supply Requirements for MegaRAID SAS 9240 RAID Controllers

All power is supplied to the MegaRAID SAS 9240-4i RAID controller and the MegaRAID SAS 9240-8i RAID controller through the PCIe 3.3-V rails and the 12-V rail. Onboard switching regulator circuitry operating from the 3.3-V rails and the 12-V rail provides the necessary voltages. The following states determine the typical current consumption of the controller:

- State 1: During a hard reset
- State 2: During a drive stress test
- State 3: While sitting idle at the DOS® prompt

The supply voltages are 12 V ± 8 percent (from the PCI edge connector only) and 3.3 V ± 9 percent (from the PCI edge connector only). The following table lists the power supply for the RAID controllers for each of the three states at the different voltages.

**Table 24 Power Supply for the MegaRAID SAS 9240 RAID Controllers**

PCI Edge Connector	State 1	State 2	State 3
+3.3-V supply	N/A	N/A	N/A
+12-V supply	350 mA	520 mA	470 mA
+3.3-V auxiliary supply	N/A	N/A	N/A
Total Power	4.2 W	6.24 W	5.64 W

#### 3.3.4.2 Operating and Nonoperating Conditions for MegaRAID SAS 9240 RAID Controllers

For the MegaRAID SAS 9240 RAID controllers, the operating (thermal and atmospheric) conditions are as follows:

- Relative humidity range is 20 percent to 80 percent noncondensing.
- Airflow must be at least 200 linear feet per minute (LFPM) to avoid operating the LSISAS2008 processor above the maximum ambient temperature.
- Temperature range: +10 °C to +55 °C

The parameters for the nonoperating (such as storage and transit) environment for these controllers are as follows:

- Relative humidity range is 5 percent to 90 percent noncondensing.
- Temperature range: -40 °C to +70 °C

#### 3.3.4.3 Power Supply Requirements for MegaRAID SAS 9260 RAID Controllers

All power is supplied to the MegaRAID SAS 9260-4i, SAS 9260-8i, SAS 9260CV-4i, SAS 9260CV-8i, and SAS 9260DE-8i RAID controllers through the PCIe 3.3-V rails and the 12-V rail. Onboard switching regulator circuitry operating from the 3.3-V rails and the 12-V rail provides the necessary voltages. The following states determine the typical current consumption of the controller:

- State 1: During a hard reset
- State 2: During a drive stress test
- State 3: While sitting idle at the DOS prompt

The supply voltages are 12 V  $\pm$  8 percent (from the PCI edge connector only) and 3.3 V  $\pm$  9 percent (from the PCI edge connector only). The following table lists the power supply for the RAID controllers for each of the three states at the different voltages.

**Table 25 Power Supply for MegaRAID SAS 9260 RAID Controllers**

PCI Edge Connector	State 1	State 2	State 3
+3.3-V supply	553 mA	713 mA	557 mA
+12-V supply	773 mA	923 mA	710 mA
+3.3-V auxiliary supply	N/A	N/A	N/A
Total power	11.047 W	13.362 W	10.307 W

### 3.3.4.4 Operating and Nonoperating Conditions for MegaRAID SAS 9260 RAID Controllers

For the MegaRAID SAS 9260-4i, SAS 9260-8i, SAS 9260CV-4i, SAS 9260CV-8i, and SAS 9260DE-8i RAID controllers, the operating (thermal and atmospheric) conditions are as follows:

- Relative humidity range is 20 percent to 80 percent noncondensing.
- Airflow must be at least 200 linear feet per minute (LFPM) to avoid operating the LSISAS2108 processor above the maximum ambient temperature.
- Temperature range:
  - +10 °C to +55 °C (without BBU or a CacheVault module)
  - +10 °C to +45 °C (with BBU)
  - +10 °C to +55 °C (with LSIiBBU08 mode 1 through 5)
  - +10 °C to +55 °C (with a CacheVault module)

**NOTE** The MegaRAID SAS 9260-4i RAID controller, the MegaRAID SAS 9260-8i RAID controller, and the MegaRAID SAS 9260DE-8i RAID controller support the LSIiBBU07 unit and the LSIiBBU08 unit, but the controllers do not support CacheVault modules.

The MegaRAID SAS 9260CV-4i RAID controller and the MegaRAID SAS 9260CV-8i RAID controller support the CVFM01 module and the CVPM01 module, but the controllers do not support iBBU units.

The parameters for the nonoperating (such as storage and transit) environment for these controllers are as follows:

- Relative humidity range is 5 percent to 90 percent noncondensing.
- Temperature range:
  - -40 °C to +70 °C (without BBU or a CacheVault module)
  - 0 °C to +45 °C (with BBU)
  - 0 °C to +55 °C (with a CacheVault module)

### 3.3.4.5 Power Supply Requirements for the MegaRAID SAS 9260-16i RAID Controller

All power is supplied to the MegaRAID SAS 9260-16i RAID controller through the PCIe 3.3-V rails and the 12-V rail. Onboard switching regulator circuitry operating from the 3.3-V rails and the 12-V rail provides the necessary voltages. The following states determine the typical current consumption of the controller:

- State 1: During a drive stress test
- State 2: While sitting idle at the DOS prompt

**NOTE** The MegaRAID SAS 9260-16i RAID controller supports the LSIiBBU07 unit and the LSIiBBU08 unit, but the controller does not support CacheVault modules.

The supply voltages are 12 V  $\pm$  8 percent (from the PCI edge connector only) and 3.3 V  $\pm$  9 percent (from the PCI edge connector only). The following table lists the power supply for the controller for each of the three states at the different voltages.

**Table 26 Power Supply for the MegaRAID SAS 9260-16i RAID Controller**

PCI Edge Connector	State 1	State 2
+3.3-V supply	1225 mA	1174 mA
+12-V supply	1487 mA	1426 mA
+3.3-V auxiliary supply	214 mA	26 mA
Total power	22.593 W	21.072 W

### 3.3.4.6 Operating and Nonoperating Conditions for the MegaRAID SAS 9260-16i RAID Controller

The operating (thermal and atmospheric) conditions for the MegaRAID SAS 9260-16i RAID controller are as follows:

- Relative humidity range is 20 percent to 80 percent noncondensing.
- Airflow must be at least 200 linear feet per minute (LFPM) to avoid operating the LSISAS2108 processor above the maximum ambient temperature.
- Temperature range:
  - +10 °C to +55 °C (without BBU)
  - +10 °C to +45 °C (with BBU)
  - +10 °C to +55 °C (with LSIiBBU08 mode 1 through 5)

Operating ambient temperature: +55 °C. (The iBBU unit is not included in the limit because it is present remotely in the system. You need to make sure that maximum operating ambient temperature around the LSIiBBU07 unit is 45 °C, and 55 °C for the LSIiBBU08 unit.)

**NOTE** The operating ambient temperature of these RAID controllers can be raised to +60 °C, provided the airflow over the controller is at least 300 LFPM.

The parameters for the nonoperating (such as storage and transit) environment for these controllers are as follows:

- Relative humidity range is 5 percent to 90 percent noncondensing.
- Temperature range:
  - -40 °C to +70 °C (without BBU)
  - +0 °C to +45 °C (with BBU)

### 3.3.4.7 Power Supply Requirements for the MegaRAID SAS 9261-8i RAID Controller

All power is supplied to the MegaRAID SAS 9261-8i RAID controller through the PCIe 3.3-V rails and the 12-V rail. Onboard switching regulator circuitry operating from the 3.3-V rails and the 12-V rail provides the necessary voltages. The following states determine the typical current consumption of the controller:

- State 1: During a drive stress test
- State 2: While sitting idle at the DOS prompt

The supply voltages are 12 V ± 8 percent (from the PCI edge connector only) and 3.3 V ± 9 percent (from the PCI edge connector only). The following table lists the power supply for the RAID controller for each of the three states at the different voltages.

**Table 27 Power Supply for the MegaRAID SAS 9261-8i RAID Controller**

PCI Edge Connector	State 1	State 2
+3.3-V supply	1060 mA	1083 mA
+12-V supply	1416 mA	803 mA
+3.3-V auxiliary supply (iBBU applications only)	48 mA	33 mA
Total power	20.65 W	13.32 W

**NOTE** The MegaRAID SAS 9261-8i RAID controller supports the LSiBBU07 unit and the LSiBBU08 unit, but the controller does not support CacheVault modules.

**NOTE** The charging circuitry for the battery pack on the optional iBBU battery-backed daughter card uses +12 V. If the BBU daughter card is mounted, the following power consumption figures apply in addition to the +12-V consumption figures listed in the previous table:

- During trickle charging of the battery pack: Not applicable (no trickle charge for Li-ION).
- During fast charging of the battery pack: 230 mA in +12-V current.

### 3.3.4.8 Operating and Nonoperating Conditions for the MegaRAID SAS 9261-8i RAID Controller

For the MegaRAID SAS 9261-8i RAID controller, the operating (thermal and atmospheric) conditions are as follows:

- Relative humidity range is 20 percent to 80 percent noncondensing.
- Airflow must be at least 200 linear feet per minute (LFPM) to avoid operating the LSISAS2108 processor above the maximum ambient temperature.
- Temperature range:
  - +10 °C to +55 °C (without BBU)
  - +10 °C to +45 °C (with BBU)

**NOTE** The MegaRAID SAS 9261-8i RAID controller supports the LSiBBU07 unit and the LSiBBU08 unit, but the controller does not support the CacheVault modules.

The parameters for the nonoperating (such as storage and transit) environment for these controllers are as follows:

- Relative humidity range is 5 percent to 90 percent noncondensing.
- Temperature range:
  - -40 °C to +70 °C (without BBU)
  - +0 °C to +45 °C (with BBU)

### 3.3.4.9 Power Supply Requirements for the MegaRAID SAS 9265-8i RAID Controller

All power is supplied to the MegaRAID SAS 9265-8i RAID controller through the PCIe 3.3-V rails and the 12-V rail. Onboard switching regulator circuitry operating from the 3.3-V rails and the 12-V rail provides the necessary voltages. The following states determine the typical current consumption of the controller:

- State 1: During a hard reset
- State 2: During a drive stress test
- State 3: While sitting idle at the DOS prompt

The supply voltages are 12 V  $\pm$  8 percent (from the PCI edge connector only) and 3.3 V  $\pm$  9 percent (from the PCI edge connector only). The following table lists the power supply for the RAID controller for each of the three states at the different voltages.

**Table 28 Power Supply for the MegaRAID SAS 9265-8i RAID Controller**

PCI Edge Connector	State 1	State 2	State 3
+3.3-V supply	956 mA	919 mA	916 mA
+12-V supply	809 mA	555 mA	559 mA
+3.3-V auxiliary supply	10 mA	39 mA	19 mA
Total Power	12.896 W	9.821 W	9.973 W

**NOTE**

The charging circuitry for the battery pack on the optional iBBU battery-backed daughter card uses +12 V. If the BBU daughter card is mounted, the following power consumption figures apply in addition to the +12-V consumption figures listed in [Table 28](#):

- During trickle charging of the battery pack: Not applicable (no trickle charge for Li-ION).
- During fast charging of the battery pack: 230 mA in +12-V current.

**NOTE**

The MegaRAID SAS 9265-8i RAID controller supports the LSIiBBU09 unit, but it does not support CacheVault modules.

### 3.3.4.10 Operating and Nonoperating Conditions for the MegaRAID SAS 9265-8i RAID Controller

For the MegaRAID SAS 9265-8i RAID controller, the operating (thermal and atmospheric) conditions are as follows:

- Relative humidity range is 20 percent to 80 percent noncondensing.
- Airflow must be at least 200 linear feet per minute (LFPM) to avoid operating the LSISAS2108 processor above the maximum ambient temperature.
- Temperature range:
  - +10 °C to +55 °C (without BBU)
  - +10 °C to +45 °C (with BBU)
  - +10 °C to +55 °C (with LSIiBBU09 mode 1 through 5)

The parameters for the nonoperating (such as storage and transit) environment for these controllers are as follows:

- Relative humidity range is 5 percent to 90 percent noncondensing.
- Temperature range:
  - -40 °C to +70 °C (without BBU)
  - 0 °C to +45 °C (with BBU)

### 3.3.4.11 Power Supply Requirements for the MegaRAID SAS 9265CV-8i RAID Controller

All power is supplied to the MegaRAID SAS 9265CV-8i RAID controller through the PCIe 3.3-V rails and the 12-V rail. Onboard switching regulator circuitry operating from the 3.3-V rails and the 12-V rail provides the necessary voltages. The following states determine the typical current consumption of the controller:

- State 1: During a hard reset
- State 2: During a drive stress test
- State 3: While sitting idle at the DOS prompt

The supply voltages are 12 V  $\pm$  8 percent (from the PCI edge connector only) and 3.3 V  $\pm$  9 percent (from the PCI edge connector only). The following table lists the power supply for the RAID controllers for each of the three states at the different voltages.

**Table 29 Power Supply for the MegaRAID SAS 9265CV-8i RAID Controller**

PCI Edge Connector	State 1	State 2	State 3
+3.3-V supply	582 mA	929 mA	971 mA
+12-V supply	476 mA	560 mA	614 mA
+3.3-V auxiliary supply	2.3 mA	0.7 mA	0.9 mA
Total Power	7.640 W	9.788 W	10.575 W

### 3.3.4.12 Operating and Nonoperating Conditions for the MegaRAID SAS 9265CV-8i RAID Controller

For the MegaRAID SAS 9265CV-8i RAID controller, the operating (thermal and atmospheric) conditions are as follows:

- Relative humidity range is 20 percent to 80 percent noncondensing.
- Airflow must be at least 200 linear feet per minute (LFPM) to avoid operating the LSISAS2208 processor above the maximum ambient temperature.
- Temperature range: +10 °C to +55 °C (with or without a CacheVault module)

**NOTE** The MegaRAID SAS 9265CV-8i RAID controller support the CVFM03 module and the CVPM02 module, but the controller does not support iBBU units.

The parameters for the nonoperating (such as storage and transit) environment for these controllers are as follows:

- Relative humidity range is 5 percent to 90 percent noncondensing.
- Temperature range:
  - -40 °C to +70 °C (without a CacheVault module)
  - 0 °C to +55 °C (with a CacheVault module)

### 3.3.4.13 Power Supply Requirements for the MegaRAID SAS 9266 RAID Controllers

All power is supplied to the MegaRAID SAS 9266-4i RAID controller and the MegaRAID SAS 9266-8i RAID controller through the PCIe 3.3-V rails and the 12-V rail. Onboard switching regulator circuitry operating from the 3.3-V rails and the 12-V rail provides the necessary voltages. The following states determine the typical current consumption of the controller:

- State 1: During a hard reset
- State 2: During a drive stress test
- State 3: While sitting idle at the DOS prompt

The supply voltages are 12 V ± 8 percent (from the PCI edge connector only) and 3.3 V ± 9 percent (from the PCI edge connector only). The following table lists the power supply for the RAID controllers for each of the three states at the different voltages.

**Table 30 Power Supply for MegaRAID SAS 9266 RAID Controllers**

PCI Edge Connector	State 1	State 2	State 3
+3.3-V supply	548.7 mA	916.7 mA	910 mA
+12-V supply	331 mA	723.3 mA	663.3 mA
+3.3-V auxiliary supply	0.6 mA	0.3 mA	0.1 mA
Total Power	5.783 W	11.705 W	10.959 W

**NOTE** The MegaRAID SAS 9266-8i RAID controller supports the CVFM02 module, CVPM02 module, and the LSIiBBU09 unit.

**NOTE** The charging circuitry for the battery pack on the optional iBBU battery-backed daughter card uses +12 V. If the BBU daughter card is mounted, the following power consumption figures apply in addition to the +12-V consumption figures listed in the previous table:

- During trickle charging of the battery pack: Not applicable (no trickle charge for Li-ION).
- During fast charging of the battery pack: 250 mA in +12-V current.

**NOTE** If a CVFM02 module is attached to the RAID controller, and the CVFM02 module is connected to a CVPM02 module, the following power consumption figure applies in addition to the +12-V consumption figures listed in the previous table:

- During CVPM module charge cycle: 500 mA in +12-V current.

### 3.3.4.14 Operating and Nonoperating Conditions for the MegaRAID SAS 9266 RAID Controllers

For the MegaRAID SAS 9266-4i RAID controller and the MegaRAID SAS 9266-8i RAID controller, the operating (thermal and atmospheric) conditions are as follows:

- Relative humidity range is 20 percent to 80 percent noncondensing.
- Airflow must be at least 200 linear feet per minute (LFPM) to avoid operating the LSI SAS2208 processor above the maximum ambient temperature.
- Temperature range:
  - +10 °C to +55 °C (without BBU or a CacheVault module)
  - +10 °C to +45 °C (with BBU)
  - +10 °C to +55 °C (with LSIiBBU09 mode 1 through 5)
  - +10 °C to +55 °C (with a CacheVault module)

The parameters for the nonoperating (such as storage and transit) environment for these controllers are as follows:

- Relative humidity range is 5 percent to 90 percent noncondensing.
- Temperature range:
  - -40 °C to +70 °C (without BBU or a CacheVault module)
  - 0 °C to +45 °C (with BBU)
  - 0 °C to +55 °C (with a CacheVault module)

### 3.3.4.15 Power Supply Requirements for the MegaRAID SAS 9270-8i RAID Controller

All power is supplied to the MegaRAID SAS 9270-8i RAID controller through the PCIe 3.3-V rails and the 12-V rail. Onboard switching regulator circuitry operating from the 3.3-V rails and the 12-V rail provides the necessary voltages. The following states determine the typical current consumption of the controller:

- State 1: During a hard reset
- State 2: During a drive stress test
- State 3: While sitting idle at the DOS prompt

The supply voltages are 12 V  $\pm$  8 percent (from the PCI edge connector only) and 3.3 V  $\pm$  9 percent (from the PCI edge connector only). The following table lists the power supply for the RAID controller for each of the three states at the different voltages.

**Table 31 Power Supply for the MegaRAID SAS 9270-8i RAID Controller**

PCI Edge Connector	State 1	State 2	State 3
+3.3-V supply	956 mA	919 mA	916 mA
+12-V supply	809 mA	555 mA	559 mA
+3.3-V auxiliary supply	10 mA	39 mA	19 mA
Total Power	12.896 W	9.8214 W	9.793 W

**NOTE** The MegaRAID SAS 9270-8i RAID controller supports the LSiBBU09 unit, but the controller does not support CacheVault modules.

**NOTE** The charging circuitry for the battery pack on the optional iBBU battery-backed daughter card uses +12 V. If the BBU daughter card is mounted, the following power consumption figures apply in addition to the +12-V consumption figures listed in the previous table:

- During trickle charging of the battery pack: Not applicable (no trickle charge for Li-ION).
- During fast charging of the battery pack: 230 mA in +12-V current.

### 3.3.4.16 Operating and Nonoperating Conditions for the MegaRAID SAS 9270-8i RAID Controller

For the MegaRAID SAS 9270-8i RAID controller, the operating (thermal and atmospheric) conditions are as follows:

- Relative humidity range is 20 percent to 80 percent noncondensing.
- Airflow must be at least 200 linear feet per minute (LFPM) to avoid operating the LSISAS2208 processor above the maximum ambient temperature.
- Temperature range:
  - +10 °C to +55 °C (without BBU)
  - +10 °C to +45 °C (with BBU)
  - +10 °C to +55 °C (with LSiBBU09 mode 1 through 5)

The parameters for the nonoperating (such as storage and transit) environment for these controllers are as follows:

- Relative humidity range is 5 percent to 90 percent noncondensing.
- Temperature range:
  - -40 °C to +70 °C (without BBU)
  - 0 °C to +45 °C (with BBU)



### 3.3.4.17 Power Supply Requirements for the MegaRAID SAS 9271 RAID Controllers

All power is supplied to the MegaRAID SAS 9271-4i RAID controller, the MegaRAID SAS 9271-8i RAID controller, and the MegaRAID SAS 9271-8iCC RAID controller through the PCIe 3.3-V rails and the 12-V rail. Onboard switching regulator circuitry operating from the 3.3-V rails and the 12-V rail provides the necessary voltages. The following states determine the typical current consumption of the controller:

- State 1: During a hard reset
- State 2: During a drive stress test
- State 3: While sitting idle at the DOS prompt

The supply voltages are 12 V ± 8 percent (from the PCI edge connector only) and 3.3 V ± 9 percent (from the PCI edge connector only). The following table lists the power supply for the RAID controllers for each of the three states at the different voltages.

**Table 32 Power Supply for MegaRAID SAS 9271 RAID Controllers**

PCI Edge Connector	State 1	State 2	State 3
+3.3-V supply	548.7 mA	916.7 mA	910 mA
+12-V supply	331 mA	723.3 mA	663.3 mA
+3.3-V auxiliary supply	0.6 mA	0.3 mA	0.1 mA
Total Power	5.785 W	11.7057 W	10.963 W

**NOTE** The MegaRAID SAS 9271 RAID controllers support the CVFM02 module, CVPM02 module, and the LSIiBBU09 unit.

**NOTE** The charging circuitry for the battery pack on the optional iBBU battery-backed daughter card uses +12 V. If the BBU daughter card is mounted, the following power consumption figures apply in addition to the +12-V consumption figures listed in the previous table:

- During trickle charging of the battery pack: Not applicable (no trickle charge for Li-ION).
- During fast charging of the battery pack: 250 mA in +12-V current.

**NOTE** If a CacheVault Flash Module 02 (CVFM) is attached to the RAID controller, and the CVFM02 module is connected to a CacheVault Power Module 02 (CVPM), the following power consumption figure applies in addition to the +12-V consumption figures listed in the previous table:

- During CVPM module charge cycle: 500 mA in +12-V current.

### 3.3.4.18 Operating and Nonoperating Conditions for the MegaRAID SAS 9271 RAID Controllers

For the MegaRAID SAS 9271-4i RAID controller, the MegaRAID SAS 9271-8i RAID controller, and the MegaRAID SAS 9271-8iCC RAID controller, the operating (thermal and atmospheric) conditions are as follows:

- Relative humidity range is 20 percent to 80 percent noncondensing.
- Airflow must be at least 200 linear feet per minute (LFPM) to avoid operating the LSISAS2208 processor above the maximum ambient temperature.
- Temperature range:
  - +10 °C to +55 °C (without BBU or a CacheVault module)
  - +10 °C to +45 °C (with BBU)
  - +10 °C to +55 °C (with LSIiBBU09 mode 1 through 5)
  - +10 °C to +55 °C (with a CacheVault module)

The parameters for the nonoperating (such as storage and transit) environment for these controllers are as follows:

- Relative humidity range is 5 percent to 90 percent noncondensing.
- Temperature range:
  - -40 °C to +70 °C (without BBU/a CacheVault module)
  - 0 °C to +45 °C (with BBU)
  - 0 °C to +55 °C (with a CacheVault module)

### 3.3.4.19 Power Supply Requirements for MegaRAID SAS 9280-4i4e, SAS 9280-8e, and SAS 9280DE-8e RAID Controllers

All power is supplied to the MegaRAID SAS 9280-4i4e, SAS 9280-8e, and SAS 9280DE-8e RAID controllers through the PCIe 3.3-V rails and the 12-V rail. Onboard switching regulator circuitry operating from the 3.3-V rails and the 12-V rail provides the necessary voltages. The following states determine the typical current consumption of the controller:

- State 1: During a hard reset
- State 2: During a disk stress test
- State 3: While sitting idle at the DOS prompt

The supply voltages are 12 V ± 8 percent (from the PCI edge connector only) and 3.3 V ± 9 percent (from the PCI edge connector only). The following table lists the power supply for the controller for each of the three states at the different voltages.

**Table 33 Power Supply for MegaRAID SAS 9280-4i4e, SAS 9280-8e, and SAS 9280DE-8e RAID Controllers**

PCI Edge Connector	State 1	State 2	State 3
3.3-V supply	623 mA	697 mA	617 mA
+12-V supply	813 mA	963 mA	767 mA
3.3-V auxiliary supply	N/A	N/A	N/A
Total Power	11.812 W	13.856 W	11.240 W

**NOTE** The MegaRAID SAS 9280 RAID controllers support the LSIiBBU07 unit and the LSIiBBU08 unit, but the controllers do not support CacheVault modules.

**NOTE** The charging circuitry for the battery pack on the optional iBBU battery-backed daughter card uses +12 V. If the iBBU daughter card is mounted, the following power consumption figure applies in addition to the +12-V consumption figures listed in the previous table:

- During fast charging of the battery pack: 230 mA in +12-V current.

### 3.3.4.20 Operating and Nonoperating Conditions for MegaRAID SAS 9280-4i4e, SAS 9280-8e, and SAS 9280DE-8e RAID Controllers

The operating (thermal and atmospheric) conditions for the MegaRAID SAS 9280-4i4e, SAS 9280-8e, and SAS 9280DE-8e RAID controllers are as follows:

- Relative humidity range is 20 percent to 80 percent noncondensing.
- Airflow must be at least 200 linear feet per minute (LFPM) to avoid operating the LSISAS2108 processor above the maximum ambient temperature.
- Temperature range:
  - +10 °C to +55 °C (without BBU)
  - +10 °C to +45 °C (with BBU)
  - +10 °C to +55 °C (with LSIiBBU08 mode 1 through 5)

The parameters for the nonoperating (such as storage and transit) environment for these controllers are as follows:

- Relative humidity range is 5 percent to 90 percent noncondensing.
- Temperature range:
  - -40 °C to +70 °C (without BBU)
  - 0 °C to +45 °C (with BBU)

### 3.3.4.21 Power Supply Requirements for the MegaRAID SAS 9280-16i4e RAID Controller and the MegaRAID SAS 9280-24i4e RAID Controller

All power is supplied to the MegaRAID SAS 9280-16i4e RAID controller and the MegaRAID SAS 9280-24i4e RAID controller through the PCIe 3.3-V rails and the 12-V rail. Onboard switching regulator circuitry operating from the 3.3-V rails and the 12-V rail provides the necessary voltages. The following states determine the typical current consumption of the controller:

- State 1: During a hard reset
- State 2: During a drive stress test

**NOTE** The MegaRAID SAS 9280-16i4e RAID controller supports the LSiBBU07 unit and the LSiBBU08 unit, but the controller does not support CacheVault modules.

The supply voltages are 12 V ± 8 percent (from the PCI edge connector only) and 3.3 V ± 9 percent (from the PCI edge connector only). The following table lists the power supply for the controller for each of the three states at the different voltages.

**Table 34 Power Supply for the MegaRAID SAS 9280-16i4e and SAS 9280-24i4e RAID Controllers**

PCI Edge Connector	State 1	State 2
+3.3-V supply	1174 mA	1225 mA
+12-V supply	1426 mA	1487 mA
+3.3-V auxiliary supply	26 mA	214 mA
Total power	21.072 W	22.593 W

### 3.3.4.22 Operating and Nonoperating Conditions for the MegaRAID SAS 9280-16i4e RAID Controller and the MegaRAID SAS 9280-24i4e RAID Controller

The operating (thermal and atmospheric) conditions for the MegaRAID SAS 9280-16i4e RAID controller and the MegaRAID SAS 9280-24i4e RAID controller are as follows:

- Relative humidity range is 20 percent to 80 percent noncondensing.
- Airflow must be at least 200 linear feet per minute (LFPM) to avoid operating the LSISAS2108 processor above the maximum ambient temperature.
- Temperature range:
  - +10 °C to +55 °C (without BBU)
  - +10 °C to +45 °C (with BBU)
  - +10 °C to +55 °C (with LSiBBU08 mode 1 through 5)

**NOTE** The MegaRAID SAS 9280-16i4e RAID controller and the MegaRAID SAS 9280-24i4e RAID controller support the LSiBBU07 unit and the LSiBBU08 unit, but the controllers do not support CacheVault modules.

- Operating ambient temperature: +55 °C. (The iBBU unit is not included in the limit as it is present remotely in the system. You need to make sure that maximum operating ambient temperature around the LSIiBBU07 unit is 45 °C and 55 °C for the LSIiBBU08 unit.)

**NOTE** The operating ambient temperature of these RAID controllers can be raised to +60 °C, provided the airflow over the controller is at least 300 LFPM.

The parameters for the nonoperating (such as storage and transit) environment for these controllers are as follows:

- Relative humidity range is 5 percent to 90 percent noncondensing.
- Temperature range:
  - 40 °C to +70 °C (without BBU)
  - 0 °C to +45 °C (with BBU)

### 3.3.4.23 Power Supply Requirements for the MegaRAID SAS 9285-8e RAID Controller

All power is supplied to the MegaRAID SAS 9285-8e RAID controller through the PCIe 3.3-V rails and the 12-V rail. Onboard switching regulator circuitry operating from the 3.3-V rails and the 12-V rail provides the necessary voltages. The following states determine the typical current consumption of the controller:

- State 1: During a hard reset
- State 2: During a disk stress test
- State 3: While sitting idle at the DOS prompt

The supply voltages are 12 V ± 8 percent (from the PCI edge connector only) and 3.3 V ± 9 percent (from the PCI edge connector only). The following table lists the power supply for the controller for each of the three states at the different voltages.

**Table 35 Power Supply for MegaRAID SAS 9285-8e RAID Controllers**

PCI Edge Connector	State 1	State 2	State 3
+3.3-V supply	934 mA	901 mA	893 mA
+12-V supply	807 mA	542 mA	541 mA
+3.3-V auxiliary supply (iBBU applications only)	14 mA	43 mA	43 mA
Total Power	12.812 W	9.621 W	9.581 W

**NOTE** The MegaRAID SAS 9285-8e RAID controller supports the LSIiBBU09 unit, but it does not support CacheVault modules.

**NOTE** The charging circuitry for the battery pack on the optional iBBU battery-backed daughter card uses +12 V. If the iBBU daughter card is mounted on the controller, the following power consumption figures apply in addition to the +12-V consumption figures listed in the previous table:

- During trickle charging of the battery pack: Not applicable (no trickle charge for Li-ION).
- During fast charging of the battery pack: 250 mA in +12-V current.

### 3.3.4.24 Operating and Nonoperating Conditions for the MegaRAID SAS 9285-8e RAID Controller

The operating (thermal and atmospheric) conditions for the MegaRAID SAS 9285-8e RAID controller are as follows:

- Relative humidity range is 20 percent to 80 percent noncondensing.
- Airflow must be at least 200 linear feet per minute (LFPM) to avoid operating the LSISAS2108 processor above the maximum ambient temperature.
- Temperature range:
  - +10 °C to +55 °C (without BBU)
  - +10 °C to +45 °C (with BBU)
  - +10 °C to +55 °C (with LSIiBBU09 mode 1 through 5)

The parameters for the nonoperating (such as storage and transit) environment for these controllers are as follows:

- Relative humidity range is 5 percent to 90 percent noncondensing.
- Temperature range:
  - -40 °C to +70 °C (without BBU)
  - 0 °C to +45 °C (with BBU)

### 3.3.4.25 Power Supply Requirements for the MegaRAID SAS 9285CV-8e RAID Controller

All power is supplied to the MegaRAID SAS 9285CV-8e RAID controller through the PCIe 3.3-V rails and the 12-V rail. Onboard switching regulator circuitry operating from the 3.3-V rails and the 12-V rail provides the necessary voltages. The following states determine the typical current consumption of the controller:

- State 1: During a hard reset
- State 2: During a disk stress test
- State 3: While sitting idle at the DOS prompt

The supply voltages are 12 V ± 8 percent (from the PCI edge connector only) and 3.3 V ± 9 percent (from the PCI edge connector only). The following table lists the power supply for the controller for each of the three states at the different voltages.

**Table 36 Power Supply for the MegaRAID SAS 9285CV-8e RAID Controller**

PCI Edge Connector	State 1	State 2	State 3
+3.3-V supply	593 mA	974 mA	963 mA
+12-V supply	598 mA	768 mA	816 mA
+3.3-V auxiliary supply	0.4 mA	0.3 mA	0.1 mA
Total Power	9.134 W	12.431 W	12.970 W

### 3.3.4.26 Operating and Nonoperating Conditions for the MegaRAID SAS 9285CV-8e RAID Controller

The operating (thermal and atmospheric) conditions for the MegaRAID SAS 9285CV-8e RAID controller are as follows:

- Relative humidity range is 20 percent to 80 percent noncondensing.
- Airflow must be at least 200 linear feet per minute (LFPM) to avoid operating the LSISAS2208 processor above the maximum ambient temperature.
- Temperature range: +10 °C to +55 °C (with or without a CacheVault module)

**NOTE** The MegaRAID SAS 9285CV-8e RAID controller supports the CVFM03 module and the CVPM02 module, but the controller does not support BBU units.

The parameters for the nonoperating (such as storage and transit) environment for these controllers are as follows:

- Relative humidity range is 5 percent to 90 percent noncondensing.
- Temperature range:
  - -40 °C to +70 °C (without a CacheVault module)
  - 0 °C to +55 °C (with a CacheVault module)

### 3.3.4.27 Power Supply Requirements for the MegaRAID SAS 9286-8e RAID Controller

All power is supplied to the MegaRAID SAS 9286-8e RAID controller through the PCIe 3.3-V rails and the 12-V rail. Onboard switching regulator circuitry operating from the 3.3-V rails and the 12-V rail provides the necessary voltages. The following states determine the typical current consumption of the controller:

- State 1: During a hard reset
- State 2: During a disk stress test
- State 3: While sitting idle at the DOS prompt

The supply voltages are 12 V ± 8 percent (from the PCI edge connector only) and 3.3 V ± 9 percent (from the PCI edge connector only). The following table lists the power supply for the controller for each of the three states at the different voltages.

**Table 37 Power Supply for MegaRAID SAS 9286-8e RAID Controllers**

PCI Edge Connector	State 1	State 2	State 3
+3.3-V supply	934 mA	901 mA	893 mA
+12-V supply	807 mA	542 mA	541 mA
+3.3-V auxiliary supply (iBBU applications only)	14 mA	43 mA	43 mA
Total Power	12.812 W	9.619 W	9.581 W

**NOTE** The MegaRAID SAS 9286-8e RAID controller supports the LSIiBBU09 unit, but the controller does not support CacheVault modules.

**NOTE** The charging circuitry for the battery pack on the optional iBBU battery-backed daughter card uses +12 V. If the iBBU daughter card is mounted on the controller, the following power consumption figures apply in addition to the +12-V consumption figures listed in the previous table:

- During trickle charging of the battery pack: Not applicable (no trickle charge for Li-ION).
- During fast charging of the battery pack: 250 mA in +12-V current.

### 3.3.4.28 Operating and Nonoperating Conditions for the MegaRAID SAS 9286-8e RAID Controller

The operating (thermal and atmospheric) conditions for the MegaRAID SAS 9286-8e RAID controller are as follows:

- Relative humidity range is 20 percent to 80 percent noncondensing.
- Airflow must be at least 200 linear feet per minute (LFPM) to avoid operating the LSISAS2208 processor above the maximum ambient temperature.
- Temperature range:
  - +10 °C to +55 °C (without BBU)
  - +10 °C to +45 °C (with BBU)
  - +10 °C to +55 °C (with LSIiBBU09 mode 1 through 5)

The parameters for the nonoperating (such as storage and transit) environment for these controllers are as follows:

- Relative humidity range is 5 percent to 90 percent noncondensing.
- Temperature range:
  - -40 °C to +70 °C (without BBU)
  - 0 °C to +45 °C (with BBU)

### 3.3.4.29 Power Supply Requirements for the MegaRAID SAS 9286CV-8e RAID Controller

All power is supplied to the MegaRAID SAS 9286CV-8e RAID controller through the PCIe 3.3-V rails and the 12-V rail. Onboard switching regulator circuitry operating from the 3.3-V rails and the 12-V rail provides the necessary voltages. The following states determine the typical current consumption of the controller:

- State 1: During a hard reset
- State 2: During a disk stress test
- State 3: While sitting idle at the DOS prompt

The supply voltages are 12 V ± 8 percent (from the PCI edge connector only) and 3.3 V ± 9 percent (from the PCI edge connector only). The following table lists the power supply for the controller for each of the three states at the different voltages.

**Table 38 Power Supply for the MegaRAID SAS 9286CV-8e RAID Controller**

PCI Edge Connector	State 1	State 2	State 3
+3.3-V supply	593 mA	974 mA	963 mA
+12-V supply	598 mA	768 mA	816 mA
+3.3-V auxiliary supply	0.4 mA	0.3 mA	0.1 mA
Total Power	9.134 W	12.431 W	12.970 W

### 3.3.4.30 Operating and Nonoperating Conditions for the MegaRAID SAS 9286CV-8e RAID Controller

The operating (thermal and atmospheric) conditions for the MegaRAID SAS 9286CV-8e RAID controller are as follows:

- Relative humidity range is 20 percent to 80 percent noncondensing.
- Airflow must be at least 200 linear feet per minute (LFPM) to avoid operating the LSISAS2208 processor above the maximum ambient temperature.
- Temperature range: +10 °C to +55 °C (with or without a CacheVault module).

**NOTE** The MegaRAID SAS 9286CV-8e RAID controller supports the CVFM03 module and the CVPM02 module, but the controller does not support BBU units.

The parameters for the nonoperating (such as storage and transit) environment for these controllers are as follows:

- Relative humidity range is 5 percent to 90 percent noncondensing.
- Temperature range:
  - -40 °C to +70 °C (without a CacheVault module)
  - 0 °C to +55 °C (with a CacheVault module)

### 3.3.4.31 Power Supply Requirements for the MegaRAID SAS 9286CV-8eCC RAID Controller

All power is supplied to the MegaRAID SAS 9286CV-8eCC RAID controller through the PCIe 3.3-V rails and the 12-V rail. Onboard switching regulator circuitry operating from the 3.3-V rails and the 12-V rail provides the necessary voltages. The following states determine the typical current consumption of the controller:

- State 1: During a hard reset
- State 2: During a disk stress test
- State 3: While sitting idle at the DOS prompt

The supply voltages are 12 V  $\pm$  8 percent (from the PCI edge connector only) and 3.3 V  $\pm$  9 percent (from the PCI edge connector only). The following table lists the power supply for the controller for each of the three states at the different voltages.

**Table 39 Power Supply for the MegaRAID SAS 9286CV-8eCC RAID Controller**

PCI Edge Connector	State 1	State 2	State 3
+3.3-V supply	864 mA	989 mA	986 mA
+12-V supply	832 mA	639 mA	633 mA
+3.3-V auxiliary supply	8 mA	31.2 mA	40 mA
Total Power	12.862 W	11.035 W	10.982 W

### 3.3.4.32 Operating and Nonoperating Conditions for the MegaRAID SAS 9286CV-8eCC RAID Controller

The operating (thermal and atmospheric) conditions for the MegaRAID SAS 9286CV-8eCC RAID controller are as follows:

- Relative humidity range is 20 percent to 80 percent noncondensing.
- Airflow must be at least 200 linear feet per minute (LFPM) to avoid operating the LSISAS2208 processor above the maximum ambient temperature.
- Temperature range: +10 °C to +55 °C (with or without a CacheVault module)

**NOTE** The MegaRAID SAS 9286CV-8eCC RAID controller supports the CVFM03 module and the CVPM02 module, but the controller does not support BBU units.

The parameters for the nonoperating (such as storage and transit) environment for these controllers are as follows:

- Relative humidity range is 5 percent to 90 percent noncondensing.
- Temperature range:
  - -40 °C to +70 °C (without a CacheVault module)
  - 0 °C to +55 °C (with a CacheVault module)

## 3.3.5 Safety Characteristics

All 6Gb/s MegaRAID SAS RAID controllers meet or exceed the requirements of UL flammability rating 94 V0. Each bare board is also marked with the supplier name or trademark, type, and UL flammability rating. For the boards installed in a PCIe bus slot, all voltages are lower than the SELV 42.4V limit.



---

## Glossary

### B

#### **BIOS**

Acronym for Basic Input/Output System. Software that provides basic read/write capability. Usually kept as firmware (ROM-based). The system BIOS on the motherboard of a computer boots and controls the system. The BIOS on your host adapter acts as an extension of the system BIOS.

### C

#### **configuration**

Refers to the way a computer is set up, the combined hardware components (computer, monitor, keyboard, and peripheral devices) that make up a computer system, or the software settings that allow the hardware components to communicate with each other.

### D

#### **device driver**

A program that permits a microprocessor (through the operating system) to direct the operation of a peripheral device.

#### **domain validation**

A software procedure in which a host queries a device to determine its ability to communicate at the negotiated data rate.

#### **drive group**

A group of physical drives that combines the storage space on the drives into a single segment of storage space. A hot spare drive does not actively participate in a drive group.

### E

#### **EEPROM**

Acronym for Electronically Erasable Programmable Read-Only Memory. It is a memory chip that typically stores configuration information, as it provides stable storage for long periods without electricity and can be reprogrammed. See [NVRAM](#).

#### **external SAS device**

A SAS device installed outside the computer cabinet. These devices are connected using specific types of shielded cables.

### F

#### **Fusion-MPT architecture**

An acronym for Fusion-Message Passing Technology architecture. Fusion-MPT consists of several main elements: Fusion-MPT firmware, the Fibre Channel and SCSI hardware, and the operating system-level drivers that support these architectures. Fusion-MPT architecture offers a single binary, operating system driver that supports both Fibre Channel and SCSI devices.

### H

#### **host**

The computer system in which a RAID controller is installed. It uses the RAID controller to transfer information to and from devices attached to the SCSI bus.

#### **host adapter board**

A circuit board or integrated circuit that provides a device connection to the computer system.

#### **hot spare**

An idle, powered on, standby drive that is ready for immediate use in case of drive failure. A hot spare does not contain any user data. A hot spare can be dedicated to a single redundant array or it can be part of the global hot-spare pool for all arrays managed by the controller.

When a drive fails, the controller firmware automatically replaces and rebuilds the data from the failed drive to the hot spare. Data can be rebuilt only from virtual drives with redundancy (RAID levels 1, 5, 6, 10, 50, and 60; not RAID level 0), and the hot spare must have sufficient capacity.

---

**I**

**internal SAS device**

A SAS device installed inside the computer cabinet. These devices are connected by using a shielded cable.

**M**

**main memory**

The part of computer memory that is directly accessible by the CPU (usually synonymous with RAM).

**N**

**NVRAM**

Acronym for nonvolatile random access memory. An EEPROM (electronically erasable read-only memory) chip that stores configuration information. See [EEPROM](#).

**P**

**PCI**

Acronym for peripheral component interconnect. A high-performance, local bus specification that allows the connection of devices directly to computer memory. The PCI Local Bus allows transparent upgrades from 32-bit data path at 33 MHz to 64-bit data path at 33 MHz, and from 32-bit data path at 66 MHz to 64-bit data path at 66 MHz.

**PCI Express (PCIe)**

Acronym for peripheral component interconnect Express. A high-performance, local bus specification that permits the connection of devices directly to computer memory. PCI Express is a two-way, serial connection that transfers data on two pairs of point-to-point data lines. PCI Express goes beyond the PCI specification in that it is intended as a unifying I/O architecture for various systems: desktops, workstations, mobile, server, communications, and embedded devices.

**peripheral devices**

A piece of hardware (such as a video monitor, drive, printer, or CD-ROM) used with a computer and under the control of the computer. SCSI peripherals are controlled through a MegaRAID SAS RAID controller (host adapter).

**PHY**

The interface required to transmit and receive data packets transferred across the serial bus.

Each PHY can form one side of the physical link in a connection with a PHY on a different SATA device. The physical link contains four wires that form two differential signal pairs. One differential pair transmits signals, while the other differential pair receives signals. Both differential pairs operate simultaneously and allow concurrent data transmission in both the receive and the transmit directions.

**R**

**RAID**

Acronym for Redundant Array of Independent Disks (originally Redundant Array of Inexpensive Disks). An array (group) of multiple independent drives managed together to yield higher reliability, performance, or both exceeding that of a single drive. The RAID array appears to the controller as a single storage unit. I/O is expedited because several drives can be accessed simultaneously. Redundant RAID levels (RAID levels 1, 5, 6, 10, 50, and 60) provide data protection.

**RAID levels**

A set of techniques applied to drive groups to deliver higher data availability, performance characteristics, or both to host environments. Each virtual drive must have a RAID level assigned to it.

---

## S

### SAS

Acronym for Serial Attached SCSI. A serial, point-to-point, enterprise-level device interface that leverages the proven SCSI protocol set. The SAS interface provides improved performance, simplified cabling, smaller connections, lower pin count, and lower power requirements when compared to parallel SCSI. SAS controllers leverage a common electrical and physical connection interface that is compatible with Serial ATA.

The SAS controllers support the ANSI Serial Attached SCSI Standard, Version 2.0. In addition, the controller supports the Serial ATA III (SATA III) protocol defined by the *Serial ATA Specification, Version 3.0*. Supporting both the SAS interface and the SATA III interface, the SAS controller is a versatile controller that provides the backbone of both server and high-end workstation environments. Each port on the SAS RAID controller supports SAS devices, SATA devices, or both.

### SAS device

Any device that conforms to the SAS standard and is attached to the SAS bus by a SAS cable. This includes SAS RAID controllers (host adapters) and SAS peripherals.

### SATA

Acronym for Serial Advanced Technology Attachment. A physical storage interface standard, SATA is a serial link that provides point-to-point connections between devices. The thinner serial cables allow for better airflow within the system and permit smaller chassis designs.

### SMP

Acronym for Serial Management Protocol. SMP communicates topology management information directly with an attached SAS expander device. Each PHY on the controller can function as an SMP initiator.

### SSP

Acronym for Serial SCSI Protocol. SSP enables communication with other SAS devices. Each PHY on the SAS controller can function as an SSP initiator or an SSP target.

### STP

Acronym for Serial Tunneling Protocol. STP enables communication with a SATA device through an attached expander. Each PHY on the SAS controller can function as an STP initiator.

### strip

The portion of a stripe that resides on a single drive.

### stripe size

The total drive space consumed by a stripe not including a parity drive. For example, if a stripe contains 64 KB of drive space and has 16 KB of data residing on each drive, the stripe size is 64 KB and the strip size is 16 KB.

A larger stripe size produces improved read performance, especially if most of the reads are sequential. For mostly random reads, select a smaller stripe size.

### striping

Drive striping writes data across two or more drives. Each stripe spans two or more drives but consumes only a portion of each drive. Each drive, therefore, may have several stripes. The amount of space consumed by a stripe is the same on each drive that is included in the stripe. The portion of a stripe that resides on a single drive is a strip, also known as a stripe element. Striping by itself does not provide data redundancy; striping in combination with parity provides data redundancy.

### strip size

The drive space consumed by a strip. For example, if a stripe size contains 64 KB of drive space and has 16 KB of data residing on each drive, the stripe size is 64 KB and the strip size is 16 KB. The stripe depth is four (four drives in the stripe). You can specify stripe sizes of 8 KB, 16 KB, 32 KB, 64 KB, 128 KB, 256 KB, 512 KB, or 1 MB.

RAID 0, 1, and 10 configurations for MegaRAID SAS 9240 RAID controllers are limited to 16 drives and 64K stripe size. To exceed these limitations, you can plug in a new MegaRAID SAS 9260 RAID controller or a new MegaRAID SAS 9280 RAID controller. The MegaRAID Storage Manager utility recognizes and imports the existing array with no reconfiguration required.



Storage. Networking. Accelerated.™